

Joint Operating Agreement
Between the
Midcontinent Independent System Operator, Inc.
And
PJM Interconnection, L.L.C.
(December 11, 2008)

**Joint Operating Agreement
Between the
Midcontinent Independent System Operator, Inc.
And
PJM Interconnection, L.L.C.**

**ARTICLE I
RECITALS**

This Joint Operating Agreement (“Agreement”) dated this 31st day of December, 2003, by and between PJM Interconnection, L.L.C. (“PJM”) a Delaware limited liability company having a place of business at 2750 Monroe Blvd., Audubon, Pennsylvania 19403, and the Midcontinent Independent System Operator, Inc. (“MISO”), a Delaware non-stock corporation having a place of business at 720 City Center Drive, Carmel, Indiana 46032.

WHEREAS, PJM is the regional transmission organization that provides operating and reliability functions in portions of the mid-Atlantic and Midwest States. PJM also administers an open access tariff for transmission and related services on its grid, and independently operates markets for day-ahead, real-time energy, and financially firm transmission rights;

WHEREAS, MISO is the regional transmission organization that provides operating and reliability functions in portions of the Midwest States and Canadian Provinces. MISO administers an open access tariff for transmission and related services on its grid, and is developing processes and systems to operate markets to facilitate trading of day-ahead, real-time energy, and financially firm transmission rights;

WHEREAS, the Federal Energy Regulatory Commission has ordered each regional transmission organization to develop mechanisms to address inter-regional coordination;

WHEREAS, on February 12, 2003, the Parties entered into the Agreement Concerning Inter-regional Coordination, Including Development of Joint and Common Market (“Joint and Common Market Agreement”), which provides for the establishment of an Inter-RTO Steering Committee to facilitate development of the Joint and Common Market and resolution of seams issues between the Parties;

WHEREAS, certain other electric utilities will be integrated into the systems and markets PJM administers and controls, and it is recognized that such integration may result in changed flows on the systems of PJM and MISO as they exist prior to such integration;

WHEREAS, in accordance with good utility practice and in accordance with the directives of the Federal Energy Regulatory Commission, the Parties seek to establish exchanges of information and establish or confirm other arrangements and protocols in furtherance of the reliability of their systems and efficient market operations, and to give effect to other matters required by the Federal Energy Regulatory Commission;

NOW, THEREFORE, for the consideration stated herein, and for other good and valuable consideration, including the Parties' mutual reliance upon the covenants contained herein, the receipt of which hereby is acknowledged, PJM and MISO hereby agree as follows:

ARTICLE II
ABBREVIATIONS, ACRONYMS AND DEFINITIONS

2.1 Abbreviations and Acronyms.

2.1.1 “AC”

AC shall mean alternating current.

2.1.2 “AFC”

AFC shall mean Available Flowgate Capability.

2.1.2.a “APC”

APC shall mean Adjusted Production Cost.

2.1.3 “ARR”

ARR shall mean Auction Revenue Rights.

2.1.4 “BA”

BA shall mean Balancing Authority.

2.1.5 “BAA”

BAA shall mean Balancing Authority Area.

2.1.5.a “CBBRP”

CBBRP shall mean Cross-Border Baseline Reliability Project.

2.1.5.b “CBMEP”

CBMEP shall mean Cross-Border Market Efficiency Project.

2.1.6 “CBM”

CBM shall mean Capacity Benefit Margin.

2.1.7 “CFR”

CFR shall mean Code of Federal Regulations.

2.1.8 “CIM”

CIM shall mean Common Information Model.

2.1.8.a “CTS”

CTS shall mean Coordinated Transaction Scheduling.

2.1.8.b “CTSD”

CTSD shall mean Coordinated Transaction Scheduling Dispatch.

2.1.9 “DC”

DC shall mean direct current.

2.1.10 “DFAX”

DFAX shall mean transfer distribution factors.

2.1.11 “EHV”

EHV shall mean Extra High Voltage.

2.1.12 “EMS”

EMS shall mean the respective Energy Management Systems utilized by the Parties to manage the flow of energy within their RC Areas.

2.1.13 “ERAG”

ERAG shall mean the Eastern Interconnection Reliability Assessment Group that is charged with multi-regional modeling.

2.1.14 “FERC” (or “Commission”)

FERC shall mean the Federal Energy Regulatory Commission or any successor agency thereto.

2.1.15 “FTR”

FTR shall mean financial transmission rights.

2.1.16 “GLDF”

GLDF shall mean Generation-to-Load Distribution Factor.

2.1.17 “ICCP”, “ISN” and “ICCP/ISN”

ICCP, ISN and ICCP/ISN shall mean those common communication protocols adopted to standardize information exchange.

2.1.18 “IDC”

IDC shall mean the NERC Interchange Distribution Calculator used for identifying and requesting congestion management relief.

2.1.19 “IPSAC”

IPSAC shall mean Inter-regional Planning Stakeholder Advisory Committee.

2.1.20 “IROL”

IROL shall mean Interconnection Reliability Operating Limit.

2.1.21 “ISC”

ISC shall mean the Inter-RTO Steering Committee.

2.1.21.a “ITSCED”

ITSCED shall mean Intermediate Term Security Constrained Economic Dispatch.

2.1.22 “JRPC”

JRPC shall mean the Joint RTO Planning Committee.

2.1.23 “kV”

kV shall mean kilovolt of electric potential.

2.1.24 “LBA”

LBA shall mean Local Balancing Authority.

2.1.25 “LBAA”

LBAA shall mean Local Balancing Authority Area.

2.1.25a “LEC”

LEC shall mean Lake Erie circulation.

2.1.26 “LMP”

LMP shall mean Locational Marginal Price.

2.1.26a “M2M”

M2M shall mean market-to-market.

2.1.26b “MI”

MI shall mean Michigan.

2.1.27 “MMWG”

MMWG shall mean the Multi-regional Modeling Working Group.

2.1.27a “MOPI”

MOPI shall mean the Michigan-Ontario PAR Interface.

2.1.28 “MTEP”

MTEP shall mean MISO Transmission Expansion Plan.

2.1.29 “MVAR”

MVAR shall mean megavolt amp of reactive power.

2.1.30 “MW”

MW shall mean megawatt of real power.

2.1.31 “MWh”

MWh shall mean megawatt hour of energy.

2.1.32 “NAESB”

NAESB shall mean North American Energy Standards Board or its successor organization.

2.1.33 “NERC”

NERC shall mean the North American Electricity Reliability Corporation or its successor organization.

2.1.33a “NLP”

NLP shall mean Net Load Payment.

2.1.34 “NSI”

NSI shall mean net scheduled interchange.

2.1.35 “OASIS”

OASIS shall mean the Open Access Same-Time Information System required by FERC for the posting of market and transmission data on the Internet.

2.1.36 “OATT”

OATT shall mean the applicable open access transmission tariff.

2.1.36a “ONT”

ONT shall mean Ontario.

2.1.37 “OTDF”

OTDF shall mean Outage Transfer Distribution Factor.

2.1.37a “PAR”

PAR shall mean phase angle regulator.

2.1.38 “PMAX”

PMAX shall mean the maximum generator real power output reported in MWs on a seasonal basis.

2.1.39 “PMIN”

PMIN shall mean the minimum generator real power output reported in MWs on a seasonal basis.

2.1.40 “PSS/E”

PSS/E shall mean Power System Simulator for Engineering.

2.1.41 “PTDF”

PTDF shall mean Power Transfer Distribution Factor.

2.1.42 “QMAX”

QMAX shall mean the maximum generator reactive power output reported in MVARs at full real power output of the unit.

2.1.43 “QMIN”

QMIN shall mean the minimum generator reactive power output reported in MVARs at full real power output of the unit.

2.1.44 “RC”

RC shall mean Reliability Coordinator.

2.1.45 “RCF”

RCF shall mean Reciprocal Coordinated Flowgate.

2.1.46 “RCIS”

RCIS shall mean the Reliability Coordinator Information System.

2.1.47 “RTEP”

RTEP shall mean PJM Regional Transmission Expansion Plan.

2.1.48 “RTO”

RTO shall mean regional transmission organization.

2.1.49 “SCADA”

SCADA shall mean Supervisory Control and Data Acquisition.

2.1.50 “SDX System”

SDX System shall mean the system used by NERC to exchange system data.

2.1.51 “SOL”

SOL shall mean System Operating Limit.

2.1.52 “TCUL”

TCUL shall mean tap-changing-under-load.

2.1.53 “TFC”

TFC shall mean Total Flowgate Capability.

2.1.54 “TLR”

TLR shall mean Transmission Loading Relief.

2.1.55 “TOP”

TOP shall mean Transmission Operator.

2.1.56 “TRM”

TRM shall mean Transmission Reliability Margin.

2.1.57 “UDS”

UDS shall mean Unit Dispatch Systems.

2.1.58 “VAR”

VAR shall mean volt ampere reactive.

2.2 Definitions.

Any undefined, capitalized terms used in this Agreement shall have the meaning given under industry custom and, where applicable, in accordance with good utility practices.

2.2.1 “a & b multipliers”

“a & b Multipliers” shall mean the multipliers that are applied to TRM in the planning horizon and in the operating horizon to determine non-firm AFC. The “a” multiplier is applied to TRM in the planning horizon to determine non-firm AFC. The “b” multiplier is applied to TRM in the operating horizon to determine non-firm AFC. The “a & b” multipliers can vary between 0 and 1, inclusive. They are determined by individual transmission providers based on network reliability considerations.

2.2.2 “Affected System”

Affected System shall mean the electric system of the Party other than the Party to which a request for interconnection or long-term firm delivery service is made and that may be affected by the proposed service.

2.2.3 “Agreement”

Agreement shall mean this document, as amended from time to time, including all attachments, appendices, and schedules.

2.2.4 “American Electric Power”

American Electric Power shall mean the American Electric Power Company.

2.2.4.a “Attaining Balancing Authority” or “Attaining BA”

Attaining Balancing Authority shall have the same meaning set forth in the then current version of the NERC Glossary of Terms used in NERC Reliability Standards.

2.2.4.b “Attaining Balancing Authority Area” or “Attaining BAA”

The Attaining Balancing Authority Area shall have the same meaning set forth in the then current version of the NERC Glossary of Terms Used in NERC Reliability Standards

2.2.4.c “Attaining Reliability Coordinator” or “Attaining RC”

The Attaining Reliability Coordinator is the entity that is responsible for Reliable Operation of the Bulk Electric System, as those terms are defined in the NERC Glossary of Terms, for the Attaining Balancing Authority.

2.2.4.d “Attaining Transmission Operator” or “Attaining TOP”

The Attaining Transmission Operator is the entity that operates or directs operations for the reliability of the Attaining BAA Transmission System.

2.2.5 “Available Flowgate Capability”

Available Flowgate Capability shall mean the rating of the applicable Flowgate less the projected loading across the applicable Flowgate less TRM and CBM. The firm AFC is calculated with only the appropriate Firm Transmission Service reservations (or

interchange schedules) in the model, including recognition of all roll-over Transmission Service rights. Non-firm AFC is determined with appropriate firm and non-firm reservations (or interchange schedules) modeled.

2.2.6 “Balancing Authority”

Balancing Authority shall mean the responsible entity that integrates resource plans ahead of time, maintains load-interchange-generation balance within a Balancing Authority Area, and supports interconnection frequency in real-time. For MISO references to a BA may be applicable to a BA and/or an LBA.

2.2.7 “Balancing Authority Area”

Balancing Authority Area shall mean the collection of generation, transmission, and loads within the metered boundaries of the BA. The BA maintains load-resource balance within this area. For MISO references to a BAA may be applicable to a BAA and/or an LBAA.

2.2.8 “Bulk Electric System”

Bulk Electric System shall mean the electrical generation resources, transmission lines, interconnections with neighboring systems, and associated equipment, generally operated at voltages of 100 kV or higher. Radial transmission facilities serving load with only one transmission source are generally not included in this definition.

2.2.9 “Commonwealth Edison”

Commonwealth Edison shall mean the Commonwealth Edison Company.

2.2.10 “Confidential Information”

Confidential Information shall have the meaning stated in Section 18.1.1.

2.2.11 “Congestion Management Process”

Congestion Management Process means that document incorporated herein as Attachment 2 to this Agreement hereto as it exists on the Effective Date and as it may be amended or revised from time to time.

2.2.11.1 “Constraint Relaxation Logic”

Constraint Relaxation Logic shall mean the logic applied in the market clearing software where the transmission limit is increased to prevent the Transmission Constraint Penalty Factor from setting the shadow price of a M2M Flowgate that is constrained.

2.2.12 “Coordinated Flowgate”

Coordinated Flowgate shall mean a Flowgate impacted by an Operating Entity as determined by one of the five studies detailed in Section 3 of the attached document entitled “Congestion Management Process.” For a Market-Based Operating Entity, these Flowgates will be subject to the requirements under the Congestion Management portion of the Congestion Management Process (Sections 4 and 5). A Coordinated Flowgate may be under the operational control of a Third Party.

2.2.13 “Coordinated Operations”

Coordinated Operations means all activities that will be undertaken by the Parties pursuant to this Agreement.

2.2.14 “Coordinated System Plan”

Coordinated System Plan shall have the meaning stated in Section 9.3.7.

2.2.14.1.a “Coordinated Transaction Scheduling” or “CTS”

Coordinated Transaction Scheduling or CTS shall mean the market rules that allow real-time transactions to be scheduled based on a market participant’s willingness to purchase energy from a source in either the MISO or PJM Balancing Authority Area and sell it at a sink in the other Balancing Authority Area if the forecasted price at the sink minus the forecasted price at the corresponding source is greater than or equal to the dollar value specified in the bid.

2.2.14.1.b “Coordinated Transaction Scheduling Dispatch” or “CTSD”

Coordinated Transaction Scheduling Dispatch or CTSD shall mean MISO’s algorithm that performs various functions, including but not limited to forecasting dispatch and market clearing prices based on current and projected system conditions for up to several hours in the future.

2.2.14.a “Cross-Border Baseline Reliability Project”

Cross-Border baseline Reliability Project shall have the meaning stated in Section 9.4.4.1.1.

2.2.14.b “Cross-Border Market Efficiency Project”

Cross-Border Market Efficiency Project shall have the meaning stated in Section 9.4.4.1.2.

2.2.15 “Cross-Border Grandfathered Projects”

Cross Border Grandfathered Projects shall mean the Cross-Border Grandfathered Projects document incorporated herein as Attachment 4 to this Agreement, hereto as it exists on the Effective Date and as it may be amended or revised from time to time.

2.2.16 “Economic Dispatch”

Economic Dispatch shall mean the sending of dispatch instructions to generation units to minimize the cost of reliably meeting load demands.

2.2.17 “Effective Date”

Effective Date shall have the meaning stated in Section 12.1.

2.2.18 “Emergency Energy Transactions”

Emergency Energy Transactions shall mean the Emergency Energy Transactions document incorporated herein as Attachment 5 to this Agreement, hereto as it exists on the Effective Date and as it may be amended or revised from time to time.

2.2.19 “Extra High Voltage”

Extra High Voltage shall mean 230 kV facilities and above stations with voltage regulating capabilities.

2.2.20 “Facilities Study”

Facilities Study shall mean a study conducted by the Transmission Service Provider, or its agent, for the interconnection customer to determine a list of facilities, the cost of those facilities, and the time required to interconnect a generating facility with the transmission system or enable the sale of firm transmission service.

2.2.21 “Feasibility Study”

Feasibility Study shall mean a preliminary evaluation of the system impact of interconnecting a generating facility to the transmission system or the initial review of a transmission service request.

2.2.22 “Firm Flow”

Firm Flow shall mean the estimated impacts of Firm Transmission Service on a particular Coordinated Flowgate.

2.2.23 “Firm Flow Limit”

Firm Flow Limit shall mean the maximum value of Firm Flows an entity can have on a Coordinated Flowgate, based on procedures defined in Sections 4 and 5 of the Congestion Management Process.

2.2.24 “Flowgate”

Flowgate shall mean a representative modeling of facilities or groups of facilities that may act as significant constraint points on the regional system.

2.2.25 “Generation Resource”

Generation Resource shall mean a PJM Generation Capacity Resource, as that term is defined in the PJM Reliability Assurance Agreement, or a MISO Generation Resource or Capacity Resource, as those terms are defined in Module A of MISO Open Access Transmission, Energy and Operating Reserve Markets Tariff.

2.2.25.a “Generator Pseudo-Tie Market Flow Adjustment”

Generator Pseudo-Tie Market Flow Adjustment shall mean the amount of calculated energy flows removed from the Attaining Balancing Authority Market Flow for a specified Flowgate representative of the portion of the path from the location of the pseudo-tied generator to the MISO-PJM border.

2.2.26 “Governing Documents”

Governing Documents shall mean the PJM Open Access Transmission Tariff, the PJM Operating Agreement, the PJM Consolidated Transmission Owners Agreement, the PJM Reliability Assurance Agreement, the MISO Open Access Transmission and Energy and Operating Reserve Markets Tariff, the Agreement of Transmission Facilities Owners To Organize The Midcontinent Independent System Operator, Inc., A Delaware Non-Stock Corporation,” or any other applicable agreement approved by the FERC and intended to govern the relationship by and among PJM and MISO and any of their respective members or market participants.

2.2.26.a “Hold Harmless Issues”

Hold Harmless Issues shall have the meaning given in Section 4.3.

2.2.27 “Intellectual Property”

Intellectual Property shall mean (i) ideas, designs, concepts, techniques, inventions, discoveries, or improvements, regardless of patentability, but including without limitation patents, patent applications, mask works, trade secrets, and know-how; (ii) works of authorship, regardless of copyright ability, including copyrights and any moral rights recognized by law; and (iii) any other similar rights, in each case on a worldwide basis.

2.2.28 “Interconnection Service”

Interconnection Service shall mean the service provided by the Transmission Service Provider associated with interconnecting the generating facility to the transmission system and enabling it to receive electric energy and capacity from the generating facility at the point of interconnection, pursuant to the terms of the generator interconnection agreement and, if applicable, the tariff.

2.2.29 “Interconnection Study”

Interconnection Study shall mean any of the following studies: the interconnection Feasibility Study, the interconnection System Impact Study, and the interconnection Facilities Study, or the restudy of any of the above, described in the generator interconnection procedures.

2.2.30 “Interconnection Reliability Operating Limit”

Interconnection Reliability Operating Limit shall mean a System Operating Limit that, if violated could lead to instability, uncontrolled separation(s) or cascading outages that adversely impact the reliability of the Bulk Electric System.

2.2.30.a “Intermediate Term Security Constrained Economic Dispatch”

Intermediate Term Security Constrained Economic Dispatch shall mean PJM’s algorithm that performs various functions, including but not limited to forecasting dispatch and LMP solutions based on current and projected system conditions for up to several hours into the future.

2.2.31 “Interregional Coordination Process”

Interregional Coordination Process shall mean the market-to-market coordination document incorporated herein as Attachment 3 to this Agreement, hereto as it exists on the Effective Date and as it may be amended or revised from time to time.

2.2.32 “Inter-regional Planning Stakeholder Advisory Committee”

Inter-regional Planning Stakeholder Advisory Committee shall have the meaning given under Section 9.1.2.

2.2.33 “Inter-RTO Steering Committee”

Inter-RTO Steering Committee shall have the meaning given in the Joint and Common Market Agreement.

2.2.34 “Joint and Common Market”

Joint and Common Market shall mean, a group of initiatives that are intended to result in achievement of the following objectives: (i) Provide the highest level of inter-regional reliability; (ii) Deliver the lowest cost energy and ancillary services to load across the combined MISO and PJM Markets; and (iii) Plan, build and operate the combined MISO and PJM transmission facilities for maximum joint benefit across the markets.

2.2.35 “Joint and Common Market Agreement”

Joint and Common Market Agreement shall mean the Agreement Concerning Inter-regional Coordination, Including Development of Joint and Common Market, executed by the Parties on or about February 12, 2003.

2.2.36 “Joint Coordinated System Plan”

Joint Coordinated System Plan shall have the meaning given under Section 9.3.2.

2.2.37 “Local Balancing Authority”

Local Balancing Authority shall mean an operational entity which is: (i) responsible for compliance to NERC for the subset of NERC Balancing Authority Reliability Standards defined for its local area within the MISO Balancing Authority Area, and (ii) a party (other than MISO) to the Balancing Authority Amended Agreement which, among other things, establishes the subset of NERC Balancing Authority Reliability Standards for which the LBA is responsible.

2.2.38 “Local Balancing Authority Area”

Local Balancing Authority Area shall mean the collection of generation, transmission, and loads that are within the metered boundaries of an LBA.

2.2.39 “Locational Marginal Price” or “LMP”

Locational Marginal Price or LMP shall mean the market clearing price for energy at a given location in a Party’s RC Area, and “Locational Marginal Pricing” shall mean the processes related to the determination of the LMP.

2.2.40 “LMP Contingency Processor”

LMP Contingency Processor shall mean that Locational Marginal Price pricing computer program referred to in Section 11.2.1.

2.2.41 “Market-Based Operating Entity”

Market-Based Operating Entity shall mean an Operating Entity that operates a security constrained, bid-based economic dispatch bounded by a clearly defined market area.

2.2.42 “Market Flows”

Market Flows shall mean the calculated energy flows on a specified Flowgate as a result of dispatch of generating resources serving market load within a Market-Based Operating Entity’s market (excluding tagged transactions).

2.2.43 “Market Monitor”

Market Monitor shall monitor market power and other competitive conditions in the Markets and make reports and recommendations as appropriate.

2.2.44 “MISO”

MISO has the meaning stated in the preamble of this Agreement.

2.2.44.a “MOPI M2M Flowgate”

MOPI M2M Flowgate shall mean a Flowgate subject to the requirements in Section 10 of the Interregional Coordination Process.

2.2.44.b “Native Balancing Authority” or “Native BA”

The Native Balancing Authority shall have the same meaning set forth in the then current version of the NERC Glossary of Terms Used in NERC Reliability Standards.

2.2.44.c “Native Balancing Authority Area” or “Native BAA”

The Native Balancing Authority Area shall have the same meaning set forth in the then current version of the NERC Glossary of Terms Used in NERC Reliability Standards.

2.2.44.d “Native Reliability Coordinator” or “Native RC”

The Native Reliability Coordinator is the entity that is responsible for Reliable Operation of the Bulk Electric System, as those terms are defined in the NERC Glossary of Terms, where the pseudo-tied unit is physically located.

2.2.44.e “Native Transmission Operator” or “Native TOP”

The Native Transmission Operator is the entity that operates or directs operations for the reliability of the local transmission system where the pseudo-tied unit is physically located.

2.3.45 “NERC Compliance Registry”

NERC Compliance Registry shall mean a listing of all organizations subject to compliance with the approved reliability standards.

2.2.46 “Network Upgrades”

Network Upgrades shall have the meaning as defined in MISO and PJM tariffs.

2.2.47 “Notice”

Notice shall have the meaning stated in Section 18.10.

2.2.48 “Operating Entity”

Operating Entity shall mean an entity that operates and controls a portion of the bulk transmission system with the goal of ensuring reliable energy interchange between generators, loads, and other operating entities.

2.2.49 “Outages”

Outages shall mean the planned unavailability of transmission and/or generation facilities dispatched by PJM or MISO, as described in Article VII of this Agreement.

2.2.50 “Party” or “Parties”

Party or Parties refers to each party to this Agreement or both, as applicable.

2.2.51 “PJM”

PJM has the meaning stated in the preamble of this Agreement.

2.2.51.a “Project Cost”

Project Cost shall mean all costs for Network Upgrades, as determined by the RTOs to be a single transmission expansion project, including those costs associated with seeking and obtaining all necessary approvals for the design, engineering, construction, and testing the Network Upgrades. Project Cost will include costs classified by the Transmission Owners and ITCs as transmission plant using the Uniform System of Accounts or equivalent set of accounts for any Coordinating Owner, where Transmission Owners, ITCs, and Coordinating Owner have the meanings as defined under the PJM and MISO OATTs.

2.2.52 “Purchasing-Selling Entity”

Purchasing Selling Entity shall mean the entity that purchases or sells, and takes title to, energy, capacity, and interconnected operations services.

2.2.53 “Reciprocal Coordination Agreement”

Reciprocal Coordination Agreement shall mean an agreement between Operating Entities to implement the reciprocal coordination procedures defined in the Congestion Management Process.

2.2.54 “Reciprocal Coordinated Flowgate”

Reciprocal Coordinated Flowgate shall mean a Flowgate that is subject to reciprocal coordination by Operating Entities, under either this Agreement (with respect to Parties only) or a Reciprocal Coordination Agreement between one or more Parties and one or more Third Party Operating Entities. An RCF is:

- A Coordinated Flowgate that is (a) (i) within the operational control of a Reciprocal Entity or (ii) may be subject to the supervision of a Reciprocal Entity as a RC, and (b) affected by the transmission of energy by the Parties or by either Party of both Parties and one or more Reciprocal Entities; or
- A Coordinated Flowgate that is (a) affected by the transmission of energy by one or more Parties and one or more Third Party Operating Entities, and (b) expressly made subject to CMP reciprocal coordination procedures under a Reciprocal Coordination Agreement between or among such Parties and Third Party Operating Entities; or
- A Coordinated Flowgate that is designated by agreement of both Parties as a RCF.

2.2.55 “Reciprocal Entity”

Reciprocal Entity shall mean an entity that coordinates the future-looking management of Flowgate capability in accordance with a reciprocal agreement as described in the Congestion Management Process.

2.2.55.a “Regionally Beneficial Project”

Regionally Beneficial Project shall have the meaning defined under Attachment FF of the MISO OATT.

2.2.56 “Reliability Coordinator”

Reliability Coordinator shall mean that party approved by NERC to be responsible for reliability of an RC Area.

2.2.57 “Reliability Coordinator Area” or “RC Area”

Reliability Coordinator Area or RC Area shall mean the collection of generation, transmission, and loads within the boundaries of the Reliability Coordinator. Its boundary coincides with one or more Balancing Authority Areas.

2.2.58 “SCADA Data”

SCADA Data shall mean the electric system security data that is used to monitor the electrical state of facilities, as specified in NERC reliability standard TOP-005.

2.2.59 “State Estimator”

State Estimator shall mean that computer model that computes the state (voltage magnitudes and angles) of the transmission system using the network model and real-time measurements. Line flows, transformer flows, and injections at the buses are calculated from the known state and the transmission line parameters. The state estimator has the capability to detect and identify bad measurements.

2.2.60 “System Impact Study”

System Impact Study shall mean an engineering study that evaluates the impact of a proposed interconnection or transmission service request on the safety and reliability of transmission system and, if applicable, an Affected System. The study shall identify and detail the system impacts that would result if the generating facility were interconnected or transmission service commenced without project modifications or system modifications.

2.2.61 “System Operating Limit”

System Operating Limit shall mean the value (such as MW, MVAR, Amperes, Frequency, or Volts) that satisfies the most limiting of the prescribed operating criteria for a specified system configuration to ensure operation within acceptable reliability criteria.

2.2.62 “Third Party”

Third Party refers to any entity other than a Party to this Agreement.

2.2.63 “Third Party Operating Entity”

Third Party Operating Entity shall refer to a Third Party entity that operates and controls a portion of the bulk transmission system with the goal of ensuring reliable energy interchange between generators, loads, and other operating entities.

2.2.64 “Total Flowgate Capability”

Total Flowgate Capability shall mean the maximum amount of power that can flow across that interface without overloading (either on an actual or contingency basis) any element of the Flowgate. The Flowgate capability is in units of megawatts. If the Flowgate is voltage or stability limited, a megawatt proxy is determined to ensure adequate voltages and stability conditions.

2.2.64.1 “Transmission Constraint Penalty Factor”

Transmission Constraint Penalty Factor shall mean the maximum cost of the redispatch incurred to control the flows across a transmission constraint and establishes the maximum limit on the shadow price, consistent with the maximum Transmission Constraint Demand Curve value in Schedule 28-A in the MISO Tariff and the value in the Amended and Restated Operating Agreement of PJM Interconnection, L.L.C., Schedule 1, Section 5.6.2 and the parallel provisions in Attachment K – Appendix of the PJM Open Access Transmission Tariff.

2.1.65 “Transmission Loading Relief”

Transmission Loading Relief shall mean the procedures used in the Eastern Interconnection as specified in NERC reliability standard IRO-006 and the NAESB business practice WEQ-008.

2.2.66 “Transmission Operator”

Transmission Operator shall mean the entity responsible for the reliability of its “local” transmission system, and that operates or directs the operations of the transmission facilities.

2.2.67 “Transmission Owner”

Transmission Owner shall mean a Transmission Owner as defined under the Parties’ respective tariff.

2.2.68 “Transmission Reliability Margin”

Transmission Reliability Margin shall mean that amount of transmission transfer capability necessary to ensure that the interconnected transmission network is secure under a reasonable range of uncertainties in system conditions.

2.2.69 “Transmission Service Provider”

Transmission Service Provider shall mean the entity that administers the transmission tariff and provides transmission service to transmission customers under applicable transmission service agreements.

2.2.70 “Transmission System Emergencies”

Transmission System Emergencies are conditions that have the potential to exceed or would exceed an IROL.

2.2.71 “Unit Dispatch Systems”

Unit Dispatch Systems shall mean those dispatch systems utilized by the Parties to dispatch generation units by calculating the most economic solution while simultaneously ensuring that each of the boundary constraints is resolved reliably.

2.2.72 “Voltage and Reactive Power Coordination Procedures”

Voltage and Reactive Power Coordination Procedures are the procedures under Article XIX for coordination of voltage control and reactive power requirements.

2.3 Rules of Construction.

2.3.1 No Interpretation Against Drafter.

In addition to their roles as RTOs and RCs, and the functions and responsibilities associated therewith, the Parties agree that each Party participated in the drafting of this Agreement and was represented therein by competent legal counsel. No rule of construction or interpretation against the drafter shall be applied to the construction or in the interpretation of this Agreement.

2.3.2 Incorporation of Preamble and Recitals.

The Preamble and Recitals of this Agreement are incorporated into the terms and conditions of this Agreement and made a part thereof.

2.3.3 Meanings of Certain Common Words.

The word “including” shall be understood to mean “including, but not limited to.” The word “Section” refers to the applicable section of this Agreement and, unless otherwise stated, includes all subsections thereof. The word “Article” refers to articles of this Agreement.

2.3.4 Certain Headings.

Certain sections of Articles IV, V, and VIII contain descriptions or statements of the purposes of, or requirements stated, in those sections. These descriptions or statements are to provide background information to assist in the interpretation of the requirements. The absence of a description or statement of purpose with respect to any requirement does not diminish the enforceability of the requirement. If a provision in Articles IV, V, and VIII is not delineated as “purpose,” “background,” or “definition,” it is a requirement.

2.3.5 NERC Reliability Standards.

All activities under this Agreement will meet or exceed the applicable NERC reliability standards as revised from time to time.

2.3.6 NAESB Business Practices.

All activities under this Agreement will meet or exceed the applicable NAESB business practices as revised from time to time.

2.3.7 Scope of Application.

Each Party will perform this Agreement in accordance with its terms and conditions with respect to each BA for which it serves as RTO and, in addition, each BA for which it serves as RC.

ARTICLE III OVERVIEW OF COORDINATION AND INFORMATION EXCHANGE

3.1 Ongoing Review and Revisions.

PJM and MISO will use this Joint Operating Agreement, to the extent applicable, for the coordination of TOP, BA, RC and other functions for which they may have registered in the NERC Compliance Registry. The Parties have agreed to the coordination and exchange of data and information under this Agreement to enhance system reliability and efficient market operations as systems exist and are contemplated as of the Effective Date. The Parties expect that these systems and technology applicable to these systems and to the collection and exchange of data will change from time to time throughout the term of this Agreement, including changes to the boundaries of a Party in its capacity as an RTO, changes to the boundaries of, or identities of, BAs or TOPs for which a Party serves as RC, changes in response to findings and recommendations of the United States Department of Energy or NERC concerning the outage of August 14, 2003, and changes upon the commencement of market-to-market implementation. The Parties agree that the objectives of this Agreement can be fulfilled efficiently and economically only if the Parties, from time to time, review and as appropriate revise the requirements stated herein in response to such changes, including deleting, adding, or revising requirements and protocols. Each Party will negotiate in good faith in response to such revisions the other Party may propose from time to time.

ARTICLE IV
EXCHANGE OF INFORMATION AND DATA

4.1 Exchange of Operating Data.

Purpose: Sharing data is necessary to facilitate effective coordination of operations and to maintain regional system reliability while assuring the maximum commercial flexibility for market participants.

Requirements: The Parties will exchange the following types of data and information on a continuous, real-time basis:

- (a) Real-Time and Projected Operating Data;
- (b) SCADA Data;
- (c) EMS Models;
- (d) Operations Planning Data; and
- (e) Planning Information and Models.

Each Party shall provide the data identified in items (a) through (e) of this Section to the other Party with respect to all entities that participate in Party's markets during the term of this Agreement, whether or not the entity is a participant as of the Effective Date.

To facilitate the exchange of all such data, each Party will designate to the other Party's Vice President of Operations a contact to be available twenty-four (24) hours each day, seven (7) days per week, and an alternate contact to act in the absence or unavailability of the primary contact, to respond to any inquiries. With respect to each contact and alternate, each Party shall provide the name, telephone number, e-mail address, and fax number. Each Party may change a designee from time to time by Notice to the other Party's Vice President of Operations.

The Parties agree to exchange data in a timely manner consistent with existing defined formats or such other formats to which the Parties may agree. If any required data exchange format has not been agreed upon as of the Effective Date, or if a Party determines that an agreed format should be revised, a Party shall give Notice of the need for an agreed format or revision and the Parties will jointly seek to complete development of the format within thirty (30) days of such Notice.

4.1.1 Real-Time and Projected Operating Data.

4.1.1.1 Requirements:

The Parties will exchange two categories of operating data (real-time information and projected information), as follows:

- (a) The real-time operating information consists of:
 - (i) Generation status of the units in each Party's RC Area;
 - (ii) Transmission line status;
 - (iii) Real-time loads;
 - (iv) Scheduled use of reservations;
 - (v) TLR information, including calculation of Market Flows;
 - (vi) Redispatch information, including the next most economical generation block to decrement/increment; and
 - (vii) List of real-time constraints that are binding in the real-time market solution.
- (b) Projected operating information consists of:
 - (i) Merit order for generators participating in the Parties' markets;
 - (ii) Maintenance schedules for generators and transmission facilities in either of the Parties' RC Area;
 - (iii) Transmission Service Reservations reflecting firm purchase and sales;
 - (iv) Independent power producer information including current operating level, projected operating levels, Outage start and end dates;
 - (v) The planned and actual operational start-up dates for any permanently added, removed or significantly altered transmission segments;
 - (vi) Points of interconnection between the two Parties that will be permanently removed or added (this information to be shared by the Party responsible for the action shortly before taking such action); and
 - (vii) The planned and actual start-up testing and operational start-up dates for any permanently added, removed or significantly altered generation units.

4.1.2 Exchange of SCADA Data.

Background: NERC reliability standard TOP-005 Attachment 1 “Electric System Reliability Data,” describes the types of data that TOPs, BAs, and Purchase Selling Entities are expected to provide, and RCs are expected to share with each other as explained in reliability standard TOP-005 “Operational Reliability Information.”

Requirements:

- (a) The Parties shall exchange requested transmission power flows, measured bus voltages and breaker equipment statuses of their bulk transmission facilities via ICCP or ISN.
- (b) Each Party shall accommodate, as soon as practical, the other Party’s requests for additional existing ICCP/ISN bulk transmission data points, but in any event no more than one (1) week after the request has been submitted.
- (c) Each Party shall respond, as soon as practical, to the other Party’s requests for additional, unavailable ICCP/ISN bulk transmission data points, but in any event no more than two (2) weeks after the request has been submitted, with an expected availability target date for the requested data.
- (d) The Parties will comply with all governing confidentiality agreements executed by the Parties relating to ICCP/ISN data.
- (e) The Parties shall exchange SCADA Data consisting of:
 - (i) Status measurements 69 kV and above (breaker statuses) (as available and required to observe for reliability as the respective Parties may determine);
 - (ii) Analog measurements 69 kV and above (flows and voltages); (as available and required to observe for reliability as the respective Parties may determine);
 - (iii) Generation point measurements, including generator output for each unit in MW and MVARs, as available;
 - (iv) Load point measurements, including bus loads and specific loads at each substation in MW and MVARs, as available;
 - (v) BAA net interchange;
 - (vi) BAA instantaneous demand;
 - (vii) BAA operating reserves; and
 - (viii) Identification of other real-time data available through ICCP/ISN.

4.1.3 Models.

Purpose: EMS models contain detailed representations of the transmission and generation configurations within each RTO and neighboring systems. The Parties depend upon EMS models for reliability coordination and market operations. The regular exchange of models is to ensure that each Party is using current and up-to-date representations of the other Party

Requirements: The Parties will exchange their detailed EMS models once a year in CIM format or another mutually agreed upon electronic format, but shall provide each other with updates of the model information in an agreed upon electronic format as new data becomes available. This yearly exchange will include the ICCP/ISN mapping files, identification of individual bus loads, seasonal equipment ratings and one-line drawing that will be used to expedite the model conversion process. The Parties will also exchange updates that represent the incremental changes that have occurred to the EMS model since the most recent update.

Pseudo-Tie Requirements: The Native Balancing Authority Area and the Attaining Balancing Authority Area shall coordinate unit modeling with respect to the rules of the Native Balancing Authority and Attaining Balancing Authority for modeling a pseudo-tie. If the Native Balancing Authority and Attaining Balancing Authority do not have this information, modeling data will be requested from the entity seeking to pseudo-tie the generating unit. This includes coordination of specific technical details for each pseudo-tie. Article 11.3 provides more detail on pseudo-tie requirements.

4.1.4 Operations Planning Data.

Purpose: Operations planning data, which defines how a system was planned and built, is basic information needed to coordinate planning and operations between the Parties.

Requirements: Upon the written request of a Party, the other Party shall provide the information specified in Sections 4.1.4.1 through 4.1.4.11 inclusive, or any components thereof. Each request shall specify the information sought and the requested frequency upon which it would be provided. A Party receiving a request under this Section shall provide the information promptly to the extent the information is available to the Party. Operations planning data is not generally considered Confidential Information but to the extent any of this data overlaps previously defined operating data in Section 4.1.2, it is considered Confidential Information.

4.1.4.1 Flowgates.

- (a) Flowgate definitions including seasonal TFC, TRM, CBM, and a & b multipliers;
- (b) Flowgates to be added on demand;
- (c) List of Coordinated and Reciprocal Coordinated Flowgates;
- (d) List of Flowgates to recognize when selling point-to-point service (if different than list of Coordinated Flowgates); and
- (e) Requirements under Section 5.1.7.

4.1.4.2 Transmission Service Reservations.

- (a) Daily list of all reservations, hourly increment of new reservations;
- (b) List of reservations to exclude;
- (c) Requirements under Sections 5.1.4 and 5.1.5; and
- (d) List of long-term firm reservations not subject to rollover rights.

4.1.4.3 Available Flowgate Capability Data.

Each Party will meet a minimum periodicity for calculating and making available AFCs to each other. The minimum periodicity depends on the service being offered. Each Party will provide the following AFC data to the other Party:

- (a) Hourly for first seven (7) days posted at a minimum, once per hour;
- (b) Daily for days eight (8) through thirty-one (31), posted at a minimum, once per day; and
- (c) Monthly for months two (2) through eighteen (18), posted at a minimum, twice per month.

4.1.4.4 Load Forecast.

- (a) Hourly for next seven (7) days, daily for days eight (8) through thirty-one (31), and monthly for months two (2) through eighteen (18), submitted once a day;
- (b) Identify the origin of the forecast (*e.g.*, identity of RTO, RC, BA, etc.);
- (c) Indicate whether this forecast includes transmission system losses, and if it does, indicate what the percent losses are;
- (d) Identify non-conforming loads;
- (e) Indicate how municipal entities, cooperatives and other entity loads are treated. Indicate whether they are included in the forecast. If so, indicate the total load or net load after removing other entity generation; and
- (f) Requirements under Section 5.1.6.

4.1.4.5 Generator Data.

- (a) Unit owner, bus location in model;
- (b) Seasonal ratings, PMIN, PMAX, QMIN, QMAX;
- (c) Station auxiliaries to extent gross generation has been reported; and
- (d) Regulated bus, target voltage and actual voltage.

4.1.4.6 Designated Network Resources.

- (a) Network Integration Transmission Service Specifications;
- (b) Designated Network Resource information; and

- (c) To the extent that Designated Network Resources operate between the markets administered by the Parties:
 - (i) Indication of treatment as pseudo tie or dynamic/static schedules;
 - (ii) Rules for sharing output between joint owners; and
 - (iii) Transmission arrangements.

4.1.4.7 BAA Net Interchange from Reservations and Tags.

- (a) Any grandfathered agreements that do not appear in OASIS; and
- (b) If tags and reservations can not be used to develop BAA net interchange, then provide hourly unit commitment information for all generators in the BAA.

4.1.4.8 Dynamic Schedules.

- (a) List of dynamic schedules;
- (b) Identification of the dynamic schedules are being used to move load between the Parties' respective RC Areas;
- (c) Identification of marginal generation zones; and
- (d) Requirements under Section 5.1.11.

4.1.4.9 Controllable Devices.

- (a) Phase shifters;
- (b) Market-dispatchable demand response resources greater than 50 MW.
- (c) DC lines; and
- (c) Back-to-back AC/DC converters.

4.1.4.10 Generation and Transmission Outages.

- (a) Generation Outages that are planned or forecast, as soon as practicable, including all data specified in Section 5.1.1;
- (b) Transmission Outages that are planned or forecast, as soon as practicable, including all data specified in Section 5.1.3; and

- (c) Notification of all forced outages of both generation and transmission resources, not to exceed 30 minutes after they are identified.

4.1.4.11 Exchange of Operating Data.

The Parties shall exchange such information as the Market Monitors of PJM and MISO may request, singly or jointly, in order to facilitate monitoring of markets in accordance with the Parties' respective FERC-approved market monitoring plans.

4.2 Access to Data to Verify Market Flow Calculations.

Each Party shall provide the other Party with data to enable the other Party independently to verify the results of the calculations that determine the market-to-market settlements under this Agreement. A Party supplying data shall retain that data for two years from the date of the settlement invoice to which the data relates, unless there is a legal or regulatory requirement for a longer retention period. The method of exchange and the type of information to be exchanged pursuant to this Section 4.2 shall be specified in writing and posted on the Parties' websites. The posted methodology shall provide that the Parties will cooperate to review the data and mutually identify or resolve errors and anomalies in the calculations that determine the market-to-market settlements. If one Party determines that it is required to self report a potential violation to the Commission's Office of Enforcement regarding its compliance with this Agreement, the reporting Party shall inform, and provide a copy of the self report to, the other Party. Any such report provided by one Party to the other shall be "confidential information" as defined in this Agreement.

4.3 **Cost of Data and Information Exchange.**

Requirements: Each Party shall bear its own cost of providing information to the other Party pursuant to Section 4.1, except to the extent this provision is contrary to (a) any solution the FERC places into effect to the “hold harmless” issues the FERC identified in *Alliance Companies*, 100 FERC ¶ 61,137 (July 31, 2002); *on rehearing*, 103 FERC ¶ 61,274 (June 4, 2003), and related clarifying orders, the “Hold Harmless Issues,” or (b) any agreement or agreements which include the following entities: Michigan and Wisconsin parties (as described in the FERC Order referenced above), Commonwealth Edison, and American Electric Power which the FERC accepts as a solution to the Hold Harmless Issues.

ARTICLE V
AFC CALCULATIONS

5.1 AFC Protocols.

Purpose: The calculation of AFC is a forecast of transmission capability that may be available for use by transmission customers. Use of transmission capability in one system can impact the loadings, voltages and stability of neighboring systems. Because of this interrelationship, neighboring entities must exchange pertinent data for each entity to determine the AFC values for its own transmission system. The exchange of data related to calculation of AFC is necessary to assure reliable coordination, and also to permit either Party to determine if, due to lack of transmission capability, it must refuse a transmission reservation in order to avoid potential overloading of facilities.

As of the date of this Agreement, the Parties use the SDX System to exchange the planned status of generators rated greater than 50 MW, outages of all interconnections and other transmission facilities operated at greater than 100 kV, and peak load forecasts. This system has the capability to house hourly data for the next seven (7) days, daily data for the next thirty one (31) days, weekly data for the next month, and monthly data for the next three years. Continued use of this tool, and associated commitments under this Agreement, will assure the Parties' ability to make reliable calculations efficiently.

5.1.1 Generation Outage Schedules.

Requirements: Each Party shall provide the other with projected status of generation availability over the next twelve (12) months or more if available. The Parties will update this data no less than once daily for the full posting horizon and more often as required by system conditions. The data will include complete generation maintenance schedules and the most current available generator availability data, such that each Party is aware of each “return date” of a generator from a scheduled or forced outage. At all times, this exchange will include the status of generators rated greater than 50 MW. If the status of a particular generator of equal to or less than 50 MW is used within a Party’s AFC calculation, the status of this unit shall also be supplied.

5.1.2 Generation Dispatch Order.

Purpose: Dispatch information combined with unit availability information permits each Party to develop a reasonably accurate dispatch for any modeled condition. This methodology is more advantageous than scaling all available generation to meet generation commitments within an area and then increasing all generation uniformly to model an export, or uniformly decreasing all generation to model an import. While excluding nuclear generation or hydro units from this scaling would provide some level of refinement, this approach is inadequate to identify transmission constraints and determine rational AFC values.

The exchange of typical generation dispatch order or generation participation factors of all units on a BAA basis and other data under this Agreement will permit each Party to appropriately model future transmission system conditions.

Requirements: As necessary to permit a Party to develop a reasonably accurate dispatch for any modeled condition, each Party will provide the other Party with a typical generation dispatch order or the generation participation factors of all units on an affected BAA basis. The generation dispatch order will be updated as required by changes in the status of the unit; however, a new generation dispatch order need not be provided more often than prior to each peak load season.

5.1.3 Transmission Outage Schedules.

Requirements: Each Party will provide the other Party with the projected status of transmission outage schedules above 100 kV over the next twelve (12) months or more if available. This data shall be updated no less than once daily for the full posting horizon and more often as required by system conditions. The data will include current, accurate and complete transmission facility maintenance schedules, including the “outage date” and “return date” of a transmission facility from a scheduled or forced outage.

5.1.4 Transmission Interchange Schedules/Net Scheduled Interchange.

Purpose: Because interchange schedules impact the short-term use of the transmission system, exchange of schedule data is necessary to determine the remaining capacity of the transmission system as well as to determine the net impact of loop flow.

Requirements: Each Party will make available to the other its reservation and interchange schedules/NSI, as required to permit accurate calculation of AFC values. Due to the high volume of this data, the Parties shall either post this data to a mutually agreed upon site for downloading or utilize tag dump information by the other Party as required by its own process and timing requirements.

In order to capture the impacts of the pseudo-tied unit on Flowgates, neither MISO, nor PJM nor the entity seeking to pseudo-tie that unit shall tag or request to tag the scheduled energy flows from a pseudo-tied Generation Resource because information about the pseudo-tie is included in the M2M congestion management procedure.

5.1.5 Reservations.

Purpose: Beyond the operating horizon, the impacts of existing transmission reservations are also necessary for the calculation of AFC for future time periods. Inasmuch as a transmission reservation is a right to use and not an obligation to use the transmission system, there is no certainty that any particular reservation will result in a corresponding interchange schedule. This is especially true considering that the *pro forma* OATT approved by the FERC allows firm service on a given path to be redirected as non-firm service on any other path. In addition, the ultimate transmission customer may not have, at a given time, purchased all transmission reservations on a particular source-to-sink path. A further complication is that the duration or firmness of the one portion of the reservation may not be the same as the remaining portion. Since prior to scheduling, it is difficult to associate reservations involving multiple Transmission Providers that may be used to complete a single transaction, double counting in the AFC determination process is a possibility. It is acknowledged that reservations respecting one Party are not required to be incorporated into transmission models developed by the other Party.

Requirements:

- (a) Each Party will make available to the other Party, upon a mutually agreed upon site, actual transmission service requests information for integration into each Party's AFC determination process.
- (b) Each Party will develop practices for modeling transmission service requests, including external requests, and netting practices for any allowance of counterflows created by reservations in electrically opposite directions. Each Party will provide the other Party with the procedures developed and implemented to model intra-party requests, requests on external parties, and reservation netting.
- (c) Each Party shall also create, maintain, and exchange a list of reservations from its OASIS that should not be considered in AFC calculations. Reasons for these exceptions include, for example, grandfathered agreements that grant access to more transmission than is necessary for the related generation capacity and unmatched intra-Party partial path reservations. If a Party does not include a reservation in its own evaluation, the reservation should be excluded in the other Party's analysis.
- (d) Each Party shall maintain a list of long-term firm reservations that are not subject to rollover rights and accordingly treat them in their process.

5.1.6 Load Data.

Requirements: The Parties will exchange forecasted peak load data for each period in accordance with NERC reliability standards and NAESB business practices (*e.g.*, daily, weekly, and monthly). Since, by definition, peak load values may only apply to one (1) hour of the period, additional assumptions must be made with respect to load level when not at peak load conditions. This is in accordance with the FERC's regulations at 18 C.F.R.¹ § 37.6(b)(4)(iv). For the next seven (7) day horizon, the Parties shall either supply hourly load forecasts or they shall supply daily peak load forecasts with a load profile. All load forecasts will be provided on a BAA or zone basis by the applicable RTO, RC, BA, or other applicable entity, including total distribution forecast by zones.

¹ The Code of Federal Regulations (CFR) is the codification of the general and permanent rules published in the Federal Register by the executive departments and agencies of the Federal Government.

5.1.7 Calculated Firm and Non-firm AFC.

Purpose: Data exchange is required to determine if a transmission service reservation (or interchange schedule) will impact Flowgates to an extent greater than the (firm or non-firm) AFC and procedures are necessary to assure that each Party respects the other Party's Flowgates as follows.

Requirements:

- (a) The Parties will exchange firm and non-firm AFC for all relevant Flowgates.
- (b) Each Party will accept or reject transmission service requests based upon projected loadings on its own Flowgates as well as on RCFs under Article VI.
- (c) Each Party will limit approvals of requests for transmission service between the Parties, including roll-over transmission service, so as to not exceed the lesser of the sum of the thermal or stability capabilities of the tie lines that interconnect the Parties, provided that firm transmission service customers retain the rollover rights and reservation priority granted to them under the applicable Party's OATT, and further provided that if explicitly stated in the applicable service agreement, a Party may limit rollover rights for new long-term firm service if there is not enough AFC to accommodate rollover rights beyond the initial term.

5.1.8 Total Flowgate Capability (Flowgate Rating).

Requirements: The Parties will exchange (seasonal, normal and emergency) Total Flowgate Capability as well as all limiting conditions (thermal, voltage, or stability). The Parties will update this information in a timely manner as required by changes on the transmission system.

5.1.9 Identification of Flowgates.

Requirements: Each Party shall consider in its TFC and AFC determination process all Flowgates: (i) that may initiate a TLR event, (ii) that are significantly impacted by their own Party's transactions, or (iii) as mutually agreed between the Parties. A Party's transactions are deemed to significantly impact another Party's Flowgates if they have a response factor equal to or greater than the response factor cut-off used by the owning Party. The Parties in their AFC determination and transmission service processing efforts shall use the response factor cut-off that the owning/operating Party uses for its Flowgates.

5.1.10 Configuration/Facility Changes (for power system model updates).

Requirements:

- (a) A mechanism will be maintained between the Parties to ensure that all significant system changes of a neighbor are incorporated in each Party's AFC calculation model. Although this information and a host of very detailed data are included in the MMWG/ERAG cases, this data exchange mechanism will address the 'major' changes that should be included in the AFC calculation models in a more timely manner. This data exchange will occur no less often than prior to each peak load season.
- (b) In addition, the Parties agree to exchange AFC calculation models of their transmission systems as soon as mechanisms can be established to facilitate this exchange.

5.1.11 Dynamic Schedule Flows.

Requirements: Each Party agrees to provide the other Party with the actual amount and future projection of dynamic schedule flows. All dynamic schedule flows and tags will be submitted in accordance with NERC policy and procedures.

5.1.12 Coordination of Transmission Reliability Margin Values.

Requirements: Each Party shall make transmission capability available for reserve sharing by including the significant impacts of the other Party's generation outages in its TRM values. The Parties will coordinate and share the necessary information for the determination of these impacts as necessary.

ARTICLE VI
RECIPROCAL COORDINATION OF FLOWGATES

6.1 Reciprocal Coordination of Flowgates Operating Protocols.

6.1.1 Reciprocal Coordinated Flowgates.

In order to coordinate congestion management proactively, each Party agrees to respect the other Party's determinations of AFC and calculations of firmness (firm, non-firm, network, non-firm hourly) for real-time operations applicable to the Party's Coordinated Flowgates. Additionally, each Party agrees to respect the allocations defined by the allocation process set forth in Section 6 of the Congestion Management Process.

6.1.2 Coordination Process for Reciprocal Coordinated Flowgates.

The Parties shall maintain the process and timing for exchanging their respective AFC calculations and Firm Flow calculations/allocations with respect to all RCFs. Further, the process will allocate Flowgate capability on a future-looking basis, including the allocation of Firm Capability for use in both internal dispatch and selling of transmission service. The Congestion Management Process sets forth the procedure for reciprocal coordination. For any controllable Flowgate, the historically determined Firm Flow on the Flowgate and any allocated rights to that Flowgate under this process are subject to the operating practices of the controllable device. The operating practices of the controllable device will be made available to MISO and PJM before a change is made. To the extent the controllable device is able to maintain the schedule across the controllable Flowgate, there are no parallel flows and a historical allocation based on parallel flows will not occur. In this instance, the use of the controllable Flowgate will be limited to entities that have arranged transmission service across the interface formed by the controllable device. To the extent the controllable device cannot maintain the schedule across the controllable Flowgate, there will be a historical allocation based on parallel flows.

6.1.3 Real-Time Operations Process.

The Parties' capabilities and real-time actions shall be governed by and in accordance with the Congestion Management Process.

6.2 Costs Arising From Reciprocal Coordination of Flowgates.

In the event redispatch occurs in order to coordinate congestion management under Section 6.1 or subparts thereof, including redispatch necessary to respect the other Party's Flowgate, as set forth in Article XI, the Party responsible for the flow that required the redispatch shall bear the costs of the redispatch.

6.3 Transmission Capability for Reserve Sharing.

Each Party shall make transmission capability available for reserve sharing by either redispatching its Flowgates or holding TRM for generation outages in the other Party's system. The Party responsible for making transmission capability available for the reserve sharing obligation shall bear the costs of the redispatch to the extent the costs may be recovered under such Party's OATT.

6.4 Maintaining Current Flowgate Models.

Each Party will maintain a detailed model of the other Party's system for operations and planning purposes. Each Party's model will be sufficiently detailed to properly honor all of that Party's Coordinated Flowgates. Furthermore, each Party will populate its model with credible data and will keep such models up-to-date.

6.5 Sharing Contract Path Capacity.

If the Parties have contract paths to the same entity, the combined contract path capacity will be made available for use by both Parties. This will not create new contract paths for either Party that did not previously exist. PJM will not be able to deal directly with companies with which it does not physically or contractually interconnect and MISO will not be able to deal directly with companies with which it does not physically or contractually interconnect.

**ARTICLE VII
COORDINATION OF OUTAGES**

7.1 Coordinating Outages Operating Protocols.

The Parties have an interregional outage coordination process for coordinating transmission and generation Outages to ensure reliability. The Parties agree to the following with respect to transmission and generation Outage coordination.

7.1.1 Exchange of Transmission and Generation Outage Schedule Data.

Upon a Party's request, the projected status of generation and transmission availability will be communicated between the Parties, subject to data confidentiality agreements. All available information regardless of scheduled date will be shared. The Parties shall exchange the most current information on proposed Outage information and provide a timely response on potential impacts of proposed Outages.

The Parties agree that this information will be shared promptly upon its availability, but no less than daily and more often as required by system conditions. The Parties shall utilize a common format for the exchange of this information. The information includes the owning Party's facility name; proposed Outage start date and time; proposed facility return date and time; date and time when a response is needed from the impacted Party to modify the proposed schedule; and any other information that may be relevant to the reliability assessment.

Each Party will also provide information independently on approved and anticipated Outages formatted as required for the SDX System.

7.1.2 Evaluation and Coordination of Transmission and Generation Outages.

The Parties will utilize network applications to analyze planned critical facility maintenance to determine its effects on the reliability of the transmission system. Each Party's Outage analysis will consider the impact of its critical Outages on the other Party's system reliability, in addition to its own. The analysis will include, as a minimum, an evaluation of contingencies, including potential real or reactive power concerns, voltage analysis and real and reactive power reserve analysis.

On a weekly basis, daily if requested by one of the Parties, the operations staff of each Party shall jointly discuss any Outages to identify potential impacts. These discussions should include an indication of either concurrence with the Outage or identify significant impact due to the Outage as scheduled. Neither Party has the authority to cancel the other Party's Outage (except transmission facilities interconnecting the two Parties' transmission systems). However, the Parties will work together to resolve any identified Outage conflicts. Consideration will be given to Outage submittal times and Outage criticality when addressing Outage conflicts. If Outage analysis indicates unacceptable system conditions, the Parties will work with one another and the facility owner(s), as necessary, to provide remedial steps to be taken in advance of proposed maintenance. If an operating procedure cannot be developed and a change to the proposed schedule is necessary based on significant impact, the Parties shall discuss the facts involved and make every effort to effect the requested schedule change. If this change cannot be accommodated, the Party with the Outage shall notify the impacted Party. A request to adjust a proposed Outage date must include, identification of the facility(s) overloaded, and identify a similar time frame of more appropriate dates/times for the Outage.

The Parties will notify each other of emergency maintenance and forced outages as soon as possible after these conditions are known (not to exceed thirty (30) minutes). The Parties will evaluate the impact of emergency and forced outages on the Parties' systems and work with one another to develop remedial steps as necessary.

Outage schedule changes, both before or after the work has started, may require additional review. Each Party will consider the impact of these changes on the other Party's system reliability, in addition to its own. The Parties will contact each other as soon as possible if these changes result in unacceptable system conditions and will work with one another to develop remedial steps as necessary.

ARTICLE VIII
PRINCIPLES CONCERNING JOINT OPERATIONS IN EMERGENCIES

8.1 Emergency Operating Principles.

Purpose: Joint emergency principles are essential due to the highly dependent nature of facilities under different authorities. The Parties are committed to reliable operation of the transmission system under normal conditions, and will work closely together during emergency situations that place the stability of the transmission system in jeopardy.

Requirements:

8.1.1

In the event an emergency condition is declared in accordance with a Party's published operating protocols, the Parties agree to provide emergency assistance to each other and to facilitate obtaining emergency assistance from a third party. The Parties will coordinate respective actions to provide immediate relief until the declaring Party eliminates the declaration of emergency. The Parties will notify each other of emergency maintenance and forced outages that would have a significant impact on the other Party as soon as possible after the conditions are known. The Parties will evaluate the impact of emergency and forced outages on the Parties' systems and coordinate to develop remedial steps as necessary or appropriate. If the emergency response allows for coordinating with the other Party before action must be taken, the normal RTO to RTO request for action will be followed. The Parties will conduct joint annual emergency drills and will ensure that all operating staff are trained and certified, if required, and will practice the joint emergency drills that include criteria for declaring an emergency, prioritized action plans, staffing and responsibilities, and communications.

8.1.2

In furtherance of maintaining system stability and providing prompt response to problems, the Parties agree that in situations where there is an actual IROL violation and/or the system is on the verge of imminent collapse, and when there exists an applicable emergency principles or operating guide, each Party will allow the affected Party to take immediate steps by modifying the normal RTO to RTO request procedure so that both Parties and affected operating entities can communicate and coordinate simultaneously via telephone conference call or other appropriate means. Subsequent to such anomalous operations, the requesting Party will prepare a lessons learned report and provide copies thereof to the other Party and affected operating entities. The purpose of the lesson learned report is to assist in improving operations so that future operations will be more proactive; thereby, avoiding such abnormal communications/procedures.

8.1.3

The Parties will work together and with the BAs with respect to which they serve as RTO or RC to jointly develop and commit to additional emergency principles and operating guides as the need for such procedures arises. Existing emergency principles and operating guides shall be reviewed annually. The Parties will make readily available to local operating entities, including BA operators, the current RTO restoration plans including the information contained therein concerning the black start plans of interconnecting entities, subject to the procedures set forth in the then current business practices of the Parties, including appropriate security and confidentiality requirements.

8.1.4

Transmission System Emergencies may be implemented when, in the judgment of either Party, the system is in an emergency condition that is characterized by the potential, either imminently or for the next contingency, for system instability or cascading, or for equipment loading or voltages significantly beyond applicable operating limits, such that stability of the system cannot be assured, or to prevent a condition or situation that in the judgment of a Party is imminently likely to endanger life or property. In the event that either it becomes necessary for either Party to declare a Transmission System Emergency for an area that is in close electrical proximity to both of the Parties' RC Areas, both Parties will declare a Transmission System Emergency or redispatch without declaring a Transmission System Emergency, and take action(s) in kind to address the situation that prompted the Transmission System Emergency consistent with safe operating mode. These actions may include:

- (a) Curtailment of equivalent amounts of firm point-to-point transactions within both Parties;
- (b) Redispatching of generation within both Parties; and
- (c) Load shedding within both Parties.

8.1.5

In situations where an actual IROL violation exists, or for the next contingency would exist, and the transmission system is currently, or for the next contingency would be, on the verge of imminent collapse, and there is not an existing emergency principle or operating guide, each Party will receive, and subject to the next two sentences of this Section implement, the instruction of the affected Party, communicate the instruction to the affected entity within its own boundary, or utilize telephone conference call capabilities or other appropriate means of communication to allow simultaneous coordination/communication between the Parties and the affected entity. All occurrences of this kind may be reviewed by either or both Parties after the fact, but the instruction of the affected Party shall be implemented when issued, except a Party may delay implementation in instances where a Party concludes that the requested action will result in a more serious condition on the transmission system, or the requested action is imminently likely to endanger life or property. Financial considerations shall have no bearing on actions taken to prevent the collapse of the transmission system.

8.1.6

In a situation where an SOL violation exists within either Party's RC Area, or for the next contingency would exist, the Parties will work together as necessary, following good utility practices, and take action in kind as required to address the situation.

8.1.7

In its capacity as RC with respect to certain BAs (as applicable), each Party has the responsibility and authority to coordinate with the other Party and, as may be provided under arrangements other than this Agreement, direct emergency action on the part of generation or transmission to protect the reliability of the network. Each Party shall

exercise such authority in accord with good utility practice as required to resolve emergency conditions in the other Party's RC Area of which it is aware and, in conjunction with its stakeholder processes, will develop detailed emergency operating procedures.

8.1.7.1 Power System Restoration.

Effective procedures for restoration of the network require coordination and communication at all levels of the Parties' organizations and with their membership. During power system restoration, the Parties will coordinate their actions with each other, as well as with other RTOs and operating entities in order to restore the transmission system as safely and efficiently as possible. In order to enhance the effectiveness of actual restoration operations between the Parties, the Parties will conduct annual coordinated restoration drills. These drills will stress cooperation and communication so that both Parties are positioned to better assist each other in an actual restoration.

8.1.7.2 Joint Voltage Stability Operating Protocol.

Voltage stability or collapse problems have the potential to cause cascading outages and therefore must be closely coordinated to maintain reliable operations. The Parties will coordinate their operations in accordance with good utility practice in order to maintain stable voltage profiles throughout their respective RC Areas. The Parties will coordinate their established daily voltage/reactive management plans. This coordination will serve to assure an adequate static and dynamic reactive supply under a credible range of system dispatch patterns across both Parties' systems and will assure the plans are complementary.

8.1.7.3 Operating the Most Conservative Result.

When any one Party identifies an overload/emergency situation that may impact the other Party's system and the other Party's results/systems do not observe a similar situation, both Parties will operate to the most conservative result until the Parties can identify the reasons for these differences(s).

8.1.8 Emergency Plans.

Each Party agrees to annually review and update its emergency energy plans. Each Party agrees to provide copies of its emergency energy plans to the other Party when the emergency plans are updated. Each Party agrees to coordinate their emergency energy plans with the other Party. The Parties recognize that part of this coordination is already established in this agreement as identified below.

8.1.8.1 Emergency Plan Coordination.

Each Party is responsible for overall Emergency Operations planning and coordination of such plans within its own BA. Each Party will include its affected member systems within its respective area into the development process of the overall normal and emergency operating procedures. Each Party agrees to coordinate its load shedding plans with the other Party and other adjacent NERC TOPs and BAs.

8.1.9 Emergency Capacity or Energy.

A Party may request emergency assistance on the terms set forth in the Emergency Energy Transactions document. Each Party agrees to notify the other Party whenever it is currently experiencing or is projected to experience an energy or capacity emergency. Parties shall establish procedures for requesting and supplying emergency energy.

ARTICLE IX
COORDINATED REGIONAL TRANSMISSION EXPANSION PLANNING

9.1 Administration; Committees.

9.1.1 Joint RTO Planning Committee.

The ISC shall form, as a subcommittee, a Joint RTO Planning Committee (JRPC), comprised of representatives of the Parties' respective staffs in numbers and functions to be identified from time to time. Each Party shall have the right, every other year, to designate a Chairman of the JRPC to serve a one-year calendar term. The ISC shall designate the first Chairman. The Chairman shall be responsible for the scheduling of meetings, the preparation of agendas for meetings, and the production of minutes of meetings. The JRPC shall coordinate the coordinated system planning under this Agreement. For the purpose of coordinated system planning, the JRPC shall meet no less than twice per year. The JRPC may meet more frequently during the development of a Coordinated System Plan as determined to be necessary by the Parties.

9.1.1.1 JRPC Responsibilities

The JRPC is the decision making body for coordinated system planning. The Interregional Planning Stakeholder Advisory Committee (IPSAC) and other stakeholder groups may provide input to the JRPC.

Responsibilities of the JRPC include the following:

- (a) On an annual basis the JRPC shall conduct a review of identified transmission issues in accordance with section 9.3.7.2.a of this Agreement;
- (b) The JRPC, with input from the IPSAC, shall determine if a Coordinated System Plan study should be performed. If yes, such study shall be performed in accordance with section 9.3.7.2.b.
- (c) Prepare and document detailed procedures for the development of power system analysis models. At a minimum, and unless otherwise agreed to by the Parties, the JRPC shall develop common power system analysis models to perform coordinated system planning, as well as models for power flow analyses, short circuit analyses, and stability analyses. For studies of interconnections in close electrical proximity at the boundaries between the systems of the Parties, the JRPC will direct the performance of a detailed review of the appropriateness of applicable power system models.
- (d) Coordinate all planning activities under this Article IX, including the exchange of data.
- (e) Support the review by any federal or provincial agency of elements of the Coordinated System Plan.

- (f) Support the review by multi-state entities to facilitate the addition of inter-state transmission facilities.
- (g) Establish working groups as necessary to provide adequate review and development of the regional plans.
- (h) Establish a schedule for the rotation of responsibility for data management, coordination of stakeholder meetings, coordination of analysis activities, report preparation, and other activities.

9.1.1.2 Participating in Multi-Party Studies

The JRPC may combine with or participate in similarly established joint planning committees amongst multiple entities engaging in coordinated planning studies under tariff provisions or established under other joint agreements to which a Party is a signatory, for the purpose of providing for broader inter-regional planning coordination.

9.1.1.3 Coordinated System Planning Website

Each Party shall host its own website for communication of information related to interregional transmission coordination procedures. Under its direction, the JRPC shall coordinate with the Parties to ensure that all information and documents posted on each Party's respective website is accurate and consistent. Each Party's website shall contain, at a minimum, the following information:

- (a) Link to this Joint Operating Agreement
- (b) Notice of scheduled IPSAC meetings
- (c) Links to materials for IPSAC meetings
- (d) Documents relating to Coordinated System Plan studies

9.1.2 **Interregional Planning Stakeholder Advisory Committee.**

The Parties shall form an IPSAC, in which participation is open to all stakeholders. The IPSAC shall facilitate stakeholder review and input into coordinated system planning with respect to the development of the Coordinated System Plan. IPSAC meetings shall be facilitated by the JRPC.

For the purpose of coordinated system planning, the IPSAC shall meet no less than once per year. The IPSAC may meet more frequently during the development of a Coordinated System Plan study as determined to be necessary by the Parties. The JRPC shall meet annually with the IPSAC to review identified transmission issues and provide input on whether a Coordinated System Plan study should be performed. IPSAC meetings shall be on a mutually agreed to date determined by the JRPC.

The IPSAC will provide input to the JRPC on whether a Coordinated System Plan study should be performed pursuant to Section 9.3.7.2.a. If it is determined by the JRPC that a study should be performed, the IPSAC will provide input to the JRPC during the performance of the Coordinated System Plan study pursuant to Section 9.3.7.2.b.

9.2 Data and Information Exchange.

9.2.1 Annual Data and Information Exchange Requirement

In support of interregional planning coordination, each Party shall provide the other with the following data and information on an annual basis and will follow the stipulations for such exchange as noted below.

- (a) Power flow models for projected system conditions for the planning horizon (up to the next ten (10) years) that include planned generation development and retirements, planned transmission facilities and seasonal load projections.
- (b) System stability models with detailed dynamic modeling of generators and other active elements.
- (c) Production cost models for projected system conditions for the planning horizon that include generation and load forecasts and planned transmission facilities.
- (d) Assumptions used in development of above power flow, stability and production cost models.
- (e) Contingency lists for use in power flow, stability, and production cost analyses.

Models provided will be consistent with those used in the respective Party's planning processes, including the processes of the NERC Transmission Planners of the Parties as may be necessary for the reviews performed under Section 9.3.5.2. Formats for the exchange of data will be agreed upon by the Parties from time to time. Parties can provide the best available information and will not be required to develop unique models to meet the requirements of this Agreement. Data compiled through other multi-regional modeling efforts can be used to meet the data exchange requirements of this Agreement as agreed to in writing by both Parties. This annual data exchange will be completed during the first quarter of the calendar year, unless Parties agree in writing to a different timeline.

9.2.2 Data and Information Exchange upon Request

In addition to the data and information specified in Section 9.2.1, each Party shall provide the other with the following data and information upon request. Unless otherwise indicated, such data and information shall be provided as requested by either Party, as available, within 30 calendar days from the date of such request or on a mutually agreed to schedule.

- (a) Any updates to data exchanged in accordance with Section 9.2.1.
- (b) Power flow models and assumptions needed for review of a Parties NERC Transmission Planner proposed plans pursuant to Section 9.3.5.2. Such models and assumptions are those that produce the Bulk Electric System needs of the Transmission Planners in the MISO and PJM regions driving reliability, economic transmission enhancement or expansion, public policy, or operational performance upgrades.

- (c) Short-circuit models for transmission systems that are relevant to the coordination of planning between the two Parties.
- (d) The regional plan document produced by the Party and any long-term or short-term reliability assessment documents produced by the Party, the timing of each planned enhancement, and estimated in-service dates.
- (e) The status of expansion studies, such that each Party has knowledge that a commitment has been made to a system enhancement as a result of any such studies.
- (f) Identification and status of interconnection and long-term firm transmission service requests that have been received, including associated studies.
- (g) Transmission system maps in electronic or hard copy format for the Party's bulk transmission system and lower voltage transmission system maps that are relevant to the coordination of planning between the two Parties.
- (h) Such other data and information as is needed for each Party to plan its own system accurately and reliably and to assess the impact of conditions existing on the system of the other Party.

9.3 Coordinated System Planning.

The primary purpose of coordinated transmission planning and development of the Coordinated System Plan is to ensure that coordinated analyses are performed to identify expansions or enhancements to transmission system capability needed to maintain reliability, improve operational performance, enhance the competitiveness of electricity markets, or promote public policy. The Parties will conduct such coordinated planning as set forth in this Section 9.3 and subsections thereof.

9.3.1 Single Party Planning.

Each Party shall engage in such transmission planning activities, including expansion plans, system impact studies, and generator interconnection studies, as are necessary to fulfill its obligations under its OATT or as it otherwise shall deem appropriate. Such planning shall conform to applicable reliability requirements of the Party, NERC, applicable regional reliability councils, or any successor organizations, and any and all applicable requirements of federal, state, or provincial laws or regulatory authorities. Each Party agrees to prepare a regional transmission planning report that documents its annual regional plan prepared according to the procedures, methodologies, and business rules documented by the region. The Parties further agree to share, on an ongoing basis, information that arises in the performance of such single party planning activities as is necessary or appropriate for effective coordination between the Parties, including, in addition to the information sharing requirements of Sections 9.2 and 9.3, information on requests received from generation resources that plan on permanently retiring or suspending operation consistent with the timelines of each Party's OATT for such studies, and the identification of proposed transmission system enhancements that may affect the Parties' respective systems.

9.3.2 Coordinated System Plan.

The Coordinated System Plan is the result of the coordination of the regional planning that is conducted under this Agreement. The Parties will coordinate any studies required to assure the reliable, efficient, and effective operation of the transmission system. Results of such coordinated studies will be included in the Coordinated System Plan as further described in Section 9.3.7. The Coordinated System Plan shall also include the results of ongoing analyses of requests for interconnection and ongoing analyses of requests for long-term firm transmission service. The Parties shall coordinate in the analyses of these ongoing service requests in accordance with Sections 9.3.3 and 9.3.4. The Coordinated System Plan shall be an integral part of the expansion plans of each Party. To the extent that the JRPC agrees to combine with or participate in similarly established joint planning committees amongst multiple planning entities engaging in coordinated planning studies as provided for under Section 9.1.1.2, the coordinated planning analyses of this Protocol may be integrated into any joint coordinated planning analyses engaged in by the multiple parties, provided that the requirements of the Coordinated System Plan are integrated into the scope of such joint coordinated planning analyses.

9.3.3 Analysis of Interconnection Requests.

In accordance with the procedures under which the Parties provide interconnection service, each Party will coordinate with the other the conduct of any studies required in determining the impact of a request for generator or merchant transmission interconnection. Results of such coordinated studies will be included in the impacts reported to the interconnection customers as appropriate. The process for coordination of interconnection studies and Network Upgrades is detailed below:

- (a) Consistent with the data exchange provisions of the Agreement, the Parties will exchange current modeling data as necessary for the study and coordination of interconnection requests. This will include the associated update of the other Party's relevant queue requests, contingency elements, monitoring elements data, and other data as may be required.
- (b) The coordinated interconnection studies will determine the potential impact on the direct connect system and on the impacted Party. The direct connect system will be responsible for communicating coordinated interconnection study results to the direct connect interconnection customer.
- (c) The queue position for MISO and PJM Interconnection Requests for purposes of affected system analysis performed by MISO and cost responsibility for the MISO identified system upgrades shall be established as follows:
 - (i) The Interconnection Requests included in the study having the earlier deadline will have the higher queue priority. The deadlines for each Party are:
 - a. The MISO Definitive Planning Phase ("DPP") cycle application deadline per the MISO OATT.
 - b. The PJM System Impact Study start date per the PJM OATT.
 - (ii) Interconnection Requests in MISO and PJM will not be considered to have equal queue priority. In the event that the deadline established under subsection (c)(i)(a) falls on the same date as the study start date established in (c)(i)(b), queue priority for such Interconnection Requests shall be established based on each RTO's respective anticipated System Impact Study start date, with the earlier start date having the higher queue priority.
- (d) The queue position assigned to PJM and MISO Interconnection Requests for purposes of affected system analysis performed by PJM and cost responsibility assignments for PJM identified system upgrades shall be established as follows:
 - (i) For Interconnection Requests submitted to PJM under PJM's OATT, the Interconnection Customer must submit a complete and fully executed Generation Interconnection Feasibility Study Agreement.

The Interconnection Customer shall be assigned a priority, or Queue Position, based on the date and time all required information and requisite deposits are received in accordance with the PJM OATT, Part VI.

- (ii) For Interconnection Requests submitted through MISO's Generator Interconnection Procedures under the MISO OATT, the Interconnection Customer shall be assigned a queue priority based on the DPP Phase II Completion Date compared to the PJM System Impact Study deadline. The queue priority for Interconnection Requests in the same MISO DPP cycle will be based on alphanumeric ordering of the Interconnection Request's project number.
- (e) The Parties will coordinate and mutually agree on the nature of studies to be performed to test the impacts of the interconnection on the potentially impacted Party.
 - (i) The transmission reinforcement and the study criteria used in the coordinated interconnection studies will conform to and incorporate provisions as outlined in the PJM and MISO Business Practices Manuals and the Parties' respective Tariffs.
 - (ii) The PJM and PJM transmission owner study requirements, reinforcement criteria and cost allocation rules will apply to studies performed to determine impacts on the PJM transmission system when PJM evaluates the impact of MISO generation on PJM transmission facilities.
 - (iii) The MISO and MISO transmission owner study requirements, reinforcement criteria and cost allocation rules will apply to studies performed to determine impacts on the MISO transmission system when MISO evaluates the impact of PJM generation on MISO transmission facilities.
 - (iv) For all tie lines between MISO and PJM, the reinforcement criteria and cost allocation rules will be applied based on which region identified the violation.
 - (v) The identification of all impacts on the Parties' transmission systems shall include a description of the required system reinforcement(s), an estimated planning level cost and construction schedule estimates of the system reinforcements.
 - (vi) If the Parties cannot mutually agree on the nature of the studies to be performed they can resolve the differences through the dispute resolution procedures documented in Article XIV of this Agreement. The Parties will strive to minimize the costs associated with the coordinated study process.

- (vii) During the course of affected system studies, MISO will sink the output of a PJM interconnection request in the same area or subregion, if applicable, as PJM and PJM will sink the output of a MISO interconnection request in the same area or subregion, if applicable, as MISO.
- (f) The affected system study for PJM Interconnection Requests will be coordinated as follows:
 - (i) During the course of its interconnection feasibility studies, PJM shall monitor the MISO transmission system and provide to MISO the draft results of the potential impacts to the MISO transmission system. This monitoring will include an examination of the potential for projects to impact the MISO system by determining whether the project under study has a ≥ 3 percent distribution factor on MISO facilities that operate below 500 kV or ≥ 10 percent distribution factor on MISO facilities that operate at or above 500 kV under system intact conditions.
 - (ii) Following issuance of the PJM Feasibility Study report and after the Interconnection Customer executes the PJM System Impact Study Agreement, PJM shall forward to MISO, at a minimum of twice per year (March 15 and September 15), information of all Interconnection Requests that are entering the System Impact Study phase, necessary for MISO and the MISO transmission owners to study the impact of the PJM Interconnection Request(s) on the MISO transmission system. MISO and the MISO transmission owners shall study the impact(s) of the PJM Interconnection Request(s) on the MISO transmission system and provide draft results to PJM by:
 - a. February 1 for PJM Interconnection Request(s) provided to MISO on or before September 15 of the previous year; and
 - b. August 1 for PJM Interconnection Request(s) provided to MISO on or before March 15 of the same year.
 - (iii) During the course of MISO's affected system interconnection study for PJM interconnection projects, MISO shall apply Energy Resource Interconnection Service (ERIS) criteria to all of PJM's Interconnection Request(s). Detailed information about the modeling process and assumptions used by MISO for such analysis when MISO is the affected system are located in MISO's Generation Interconnection Business Practices Manual, BPM-015 at section 6.
 - (iv) During the determination of reinforcements for an Interconnection Request that are required to mitigate MISO constraint(s), PJM and

MISO may identify other planned non-MISO reinforcement(s) that may alleviate such constraint(s) inside the MISO region. Under such circumstances, any PJM interconnection project relying on those reinforcement(s) shall have limited injection rights until those reinforcement(s) are placed into service. MISO shall determine the necessary injection limits associated with the PJM Interconnection Request that will be implemented in Real Time until the necessary upgrades identified through MISO's affected system analysis are in service.

- (v) The results received from MISO, including any required transmission system reinforcements, shall be included in the PJM System Impact Study or Facilities Study report consistent with the PJM OATT.
- (g) The affected system study for MISO Interconnection Requests will be coordinated as follows:
 - (i) After completion of DPP cycle application deadline and at least thirty (30) days prior to the commencement of the DPP Phase I, MISO shall perform screening analysis to monitor the PJM transmission system and provide to PJM the draft results of the potential impacts to the PJM transmission system. This monitoring will include an examination of the potential projects to impact the PJM system through determination if the project under study has a ≥ 3 percent distribution factor or ≥ 5 MW impact or ≥ 1 percent of facility rating on any PJM facilities under normal and contingency conditions.
 - (ii) No later than five (5) Business Days after the commencement of the MISO DPP Phase I study, MISO shall forward to PJM information necessary for PJM and the PJM transmission owners to study the impact of the MISO Interconnection Request(s), that entered DPP Phase I on the PJM transmission system. PJM and the PJM transmission owners may study the impact of the MISO Interconnection Request(s) on the PJM transmission system and provide any available preliminary results to MISO within 100 days following commencement of DPP Phase I.
 - (iii) Prior to commencing the MISO DPP Phase II study, MISO shall forward to PJM the latest available information necessary for PJM and the PJM transmission owners to study the impact of the MISO Interconnection Request(s) included in such study on the PJM transmission system. PJM and the PJM transmission owners shall study the impact of the MISO Interconnection Request(s) on the PJM transmission system and provide the study results to MISO no later than 30 days prior to the completion of DPP Phase II.

- (iv) Prior to commencing the MISO DPP Phase III study, MISO shall forward to PJM the latest available information necessary for PJM and the PJM transmission owners to study the impact of the MISO Interconnection Request(s) on the PJM transmission system. PJM and the PJM transmission owners may study the impact of the MISO Interconnection Request(s) on the PJM transmission system and provide the study results to MISO no later than 30 days prior to the completion of DPP Phase III.
- (v) During the course of PJM's affected system interconnection study for MISO interconnection projects, PJM shall model all MISO interconnection projects that have requested Network Resource Interconnection Service (NRIS) under the MISO OATT as a Capacity Resource under the PJM OATT and all MISO interconnection projects that have requested ERIS under the MISO OATT as an Energy Resource under the PJM OATT. All projects will be modeled and studied using the criteria and methodology described in PJM Manual 14B, section 2, and further supplemented by requirements in PJM Manual 14A, section 4. These sections detail the processes and modeling used by PJM for all its planning analyses, including affected system studies.
- (vi) The results received from PJM, including any required transmission system reinforcements, shall be included in the MISO System Impact Study report.
- (h) During the determination of reinforcements for an Interconnection Request that are required to mitigate PJM constraint(s), PJM and MISO may identify other planned non-PJM reinforcement(s) that may alleviate a constraint inside the PJM region. Under such circumstances, any MISO interconnection project relying on those reinforcement(s) shall have limited injection rights until those reinforcement(s) are placed into service. PJM shall determine the necessary injection limits associated with the MISO Interconnection Request that will be implemented in Real Time until the necessary upgrades identified through PJM's affected system analysis are in-service.
- (i) If the coordinated interconnection study identifies constraints that require infrastructure additions on the impacted system to mitigate them, then the potentially impacted Party may perform its own analysis, in conjunction with the direct connect Party's Interconnection Studies. The interconnection customer whose project requires mitigation of constraint(s) found on an impacted Party's system shall enter into the appropriate Facilities Study agreement as required under the impacted Party's OATT.
- (j) The direct connect system will collect from the interconnection customer the costs incurred by the potentially impacted Party associated with the

performance of such studies and forward collected amounts to the potentially impacted Party.

- (k) If the results of the coordinated study process indicate that Network Upgrades are required in accordance with procedures, guidelines, criteria, or standards applicable to the potentially impacted system, the direct connect system will identify the need for such Network Upgrades in the appropriate study report prepared for the interconnection customer.
- (l) Requirements for construction of such Network Upgrades will be under the terms of the applicable OATT, agreement among owners of transmission facilities subject to the control of the potentially impacted Party and consistent with applicable federal, state or provincial regulatory policy.
- (m) The Interconnection Customer whose project requires mitigation of constraint(s) found on an impacted Party's system shall enter into the appropriate Facilities Study Agreement as required under the impacted Party's Tariff.
- (n) In the event that Network Upgrades are required on the potentially impacted Party's system, then interconnection service will commence on a schedule mutually agreed upon among the Parties. This schedule will include milestones with respect to the Network Upgrade construction and the amount of service that can commence after each milestone.
- (o) Each Party will maintain a separate interconnection queue. The Parties will maintain a composite listing of interconnection requests for all interconnection projects that have been identified as potentially impacting the systems of both Parties. These lists will be presented annually to the IPSAC.

9.3.4 Analysis of Long-Term Firm Transmission Service Requests.

In accordance with applicable procedures under which the Parties provide long-term firm transmission service, the Parties will coordinate the conduct of any studies required to determine the impact of a request for such service. Results of such coordinated studies will be included in the impacts reported to the transmission service customers as appropriate. The process for the coordination of studies and Network Upgrades shall be documented in the respective Party's business practices manuals that are publicly available on each Party's website. Both Parties' manual language shall be coordinated so as to ensure the communication of requirements is consistent and includes the following:

- (a) The Parties will coordinate the calculation of AFC values associated with the service, based on contingencies on the systems of each Party that may be impacted by the granting of the service.
- (b) Upon the posting to the OASIS of a request for service, the Party receiving the request will coordinate the study of the request, pursuant to each

Party's business practices manuals, which will determine the potential impact on each Party's system. The Party receiving the request will be responsible for communicating coordinated study results to the customer requesting such service.

- (c) If the potentially impacted Party determines that its system may be materially impacted by the service, and the nature of the service is such that a request on the potentially impacted Party's OASIS is unnecessary (i.e., the potentially impacted Party is "off the path"), then the potentially impacted Party will contact the Party receiving the request and request participation in the applicable transmission service studies. The Parties will coordinate with respect to the nature of studies to be performed to test the impacts of the requested service on the potentially impacted Party, who will perform the studies. The Parties will strive to minimize the costs associated with the coordinated study process. The JRPC will develop screening procedures to assist in the identification of service requests that may impact systems of parties other than the system receiving the request.
- (d) Any coordinated studies will be performed in accordance with the mutually agreed upon study scope and timeline requirements developed by the Parties. If the Parties cannot mutually agree on the nature and timeline of the studies to be performed they can resolve the differences through the dispute resolution procedures documented in Article XIV of this Agreement.
- (e) If constraints are identified during the coordinated study on the impacted system, then the potentially impacted Party may perform its own analysis in conjunction with the studies performed by the Party that has received the request for service. The customer whose request for service requires mitigation of constraint(s) found on an impacted Party's system shall enter into the appropriate facilities study agreement as required under the impacted Party's OATT. During the Facilities Study, the potentially impacted Party will conduct its own Facilities Study as a part of the Party receiving the request's Facilities Study. The study cost estimates indicated in the study agreement between the Party receiving the request and the transmission service customer will reflect the costs and the associated roles of the study participants. The Party receiving the request will review the cost estimates submitted by all participants for reasonableness, based on expected level of participation and responsibilities in the study.
- (f) The Party receiving the request will collect from the transmission service customer and forward to the potentially impacted system the costs incurred by the potentially impacted systems associated with the performance of such studies.

- (g) If the results of a coordinated study indicate that Network Upgrades are required in accordance with procedures, guidelines, criteria, or standards applicable to the potentially impacted system, the Party receiving the request will identify the need for such Network Upgrades in the system impact study prepared for the transmission service customer.
- (h) Requirements for the construction of such Network Upgrades will be under the terms of the OATTs, agreement among owners of transmission facilities subject to the control of the potentially impacted Party and consistent with applicable federal, state, or provincial regulatory policy.
- (i) In the event that Network Upgrades are required on the potentially impacted Party's system, then transmission service will commence on a schedule mutually agreed upon among the Parties. This schedule will include milestones with respect to the Network Upgrade construction and the amount of service that can commence after each milestone.

9.3.5 Analysis of Incremental Auction Revenue Rights Requests.

The Parties will coordinate, as deemed appropriate,¹ the conduct of any studies in response to a request for Incremental Auction Revenue Rights ("Incremental ARRs") ("Incremental ARR Request") made under one Party's tariff to determine its impact on the other Party's system. Results of such coordinated studies will be included in the impacts reported to the customer requesting Incremental ARRs as appropriate. Coordination of studies and Network Upgrades will include the following:

- (a) The Parties will coordinate the base Firm Flow Entitlement values associated with the Coordinated Flowgates that may be impacted by the Incremental ARR Request.
- (b) Upon receipt of an Incremental ARR Request or the review of studies related to the evaluation of such request, the Party receiving the Incremental ARR Request will determine whether the other Party is potentially impacted. If the other Party is potentially impacted, the Party receiving the Incremental ARR Request will notify the other Party and convey the information provided in the request in addition to but not limited to the list of impacted constrained facilities.
- (c) During the System Impact Study, the potentially impacted Party may participate in the coordinated study by providing input to the studies to be performed by the Party receiving the Incremental ARR Request. The potentially impacted Party shall determine the Network Upgrades, if any, needed to mitigate constraints on identified impacted facilities. The Parties shall coordinate to ensure any proposed Network Upgrades maintain the reliability of each Party's transmission system.

- (d) Any coordinated System Impact Studies will be performed in accordance with the mutually agreed upon study timeline requirements developed by the Parties. If the Parties cannot mutually agree on the nature and timeline of the studies to be performed they can resolve the differences through the dispute resolution procedures documented in Article XIV of this Agreement in accordance with applicable tariff provisions.
- (e) During the Facilities Study, the potentially impacted Party may conduct its own Facilities Study as a part of Facilities Study being conducted by the Party that received the Incremental ARR request. The study cost estimates indicated in the Facility Study Agreement between the Party receiving the request and the Incremental ARR customer will reflect the costs and the associated roles of the study participants, including the potentially impacted Party. The Party receiving the request will review the cost estimates submitted by all participants for reasonableness, based on expected level of participation and responsibilities in the study.
- (f) The Party receiving the Incremental ARR Request shall collect from the Incremental ARR customer, and forward to the potentially impacted Party, the agreed upon payments associated with the performance of such studies.
- (g) If the results of the coordinated study indicate that Network Upgrades are required in accordance with procedures, guidelines, criteria, or standards applicable to the potentially impacted Party, the Party receiving the request will identify the need for such Network Upgrades in the System Impact Study prepared for the Incremental ARR customer.
- (h) The construction of such Network Upgrades will be subject to the terms of the potentially impacted Party's tariff, the agreement among owners transferring functional control of transmission facilities to the control of the potentially impacted Party, and applicable federal, state, or provincial regulatory policy.
- (i) In the event that Network Upgrades are required on the potentially impacted Party's system, the Incremental ARR will commence on a schedule mutually agreed upon among the Parties. This schedule will include milestones with respect to the Network Upgrade construction and the amount of service that can commence after each milestone.

¹ Infra (b).

9.3.6 Analysis of Generator Deactivations (retirements and suspensions).

- (a) The Party (“Noticed Party”) receiving a new request from a generation owner to retire, deactivate, or mothball (or suspend operations as defined under the MISO Tariff) its generation unit will notify the other Party of such deactivation request no later than five (5) business days after receipt of the notice by the Noticed Party. The other Party (“Other Party”) will determine if any study is required to evaluate potential impacts to its system due to the proposed generator deactivation in the Noticed Party’s system. Any studies required due to a notice to deactivate (retire or suspend operations as defined under the MISO Tariff) will be performed under each Party’s respective Tariff. Each Party’s regional study results will be documented and provided to the other Party for informational purposes only.
- (b) Both Parties will share all information necessary to evaluate potential impacts to their respective systems due to the notice. Such coordination shall provide for:
 - (i) Exchange of current power flow modeling data as necessary for the study and coordination of generator deactivations (retirements and suspensions). This will include the associated update of the other Party’s generator availability, contingency elements, monitoring elements data, and other data as may be required.
 - (ii) Coordination by the Parties to align the assumptions of any analyses during development of the scope of any required studies. The scope design will include, as appropriate, evaluation of the transmission system against the criteria applicable to each Party for such studies.
- (c) Following the exchange of information pursuant to section 9.3.6(b), the Other Party will conduct screening and evaluation of projects needed to mitigate identified impacts on its system. The Other Party will use reasonable efforts to perform an initial assessment and provide an indication of the impacts on its system to the Noticed Party within 65 days of receipt of the notice from the Noticed Party. The Other Party will provide a list of potential system reinforcements required on its system and estimated time for completion of those system reinforcements to the Noticed Party as soon as they are available.
- (d) Each Party will be responsible for any regional Network Upgrades or other mitigation required on their respective system as a result of a request to deactivate (retirement or suspension).

- (e) Any impact(s) on the Other Party's system identified in the analysis will not be used to determine the need to retain the generator requesting to deactivate.
- (f) The identification of Network Upgrades required for generator deactivation (retirement or suspension) in the Other Party's system may require coordination through the JRPC. The Parties will endeavor to make such information available to the JRPC in a timely manner following publication of information through the Parties' regional processes. Additional coordination, as may be needed, will be conducted pursuant to the Coordinated System Plan study process as mutually agreed to be the Parties in accordance with the provisions of Section 9.3.7.
 - (i) The JRPC will incorporate any needed regional upgrades that may be identified by the generator deactivation studies coordinated pursuant to this section 9.3.6 into the annual review processes of Section 9.3.7 for the purpose of determining if there is a more efficient or cost effective Interregional Reliability Project that may replace one or more of the identified regional Network Upgrades required for the generator deactivation.
 - (ii) The JRPC will consider the results of the deactivation analyses forwarded to the committee at the next scheduled JRPC meeting or within 30 days of receipt of the completed study information from both Parties. Depending on the timing of the receipt of the study information, the JRPC will determine the most appropriate process for including the regional deactivation results into the development of the Coordinated System Plan. Such process will include IPSAC review according to the Coordinated System Plan process of Section 9.3.7.

Throughout the interregional review process any confidentiality provisions of the Parties Tariff's will be respected. Critical identified Interregional Reliability Projects for which the need to begin development is urgent will be presented to the Parties' Boards for approval as soon as possible after identification through the Coordinated System Plan study process. Other identified Interregional Reliability Projects presented to the Parties' Boards for approval in the normal regional planning process cycle as long as this cycle does not delay the implementation of a necessary upgrade.

9.3.7 Development of the Coordinated System Plan.

9.3.7.1

Each Party agrees to assist in the preparation of a Coordinated System Plan applicable to the Parties' systems. Each Party's annual transmission planning reports will be incorporated into the Coordinated System Plan, however, neither Party shall have the right to veto any planning of the other Party nor shall either Party have the right, under this Section, to obtain financial compensation due to the impact of another Party's plans or additions. The Coordinated System Plan will be finalized only after the IPSAC has had an opportunity to review it and respond. The Coordinated System Plan shall:

- (a) Integrate the Parties' respective transmission expansion plans, including any market-based additions to system infrastructure (such as generation, market participant funded, or merchant transmission projects) and Network Upgrades identified jointly by the Parties, together with alternatives to Network Upgrades that were considered;
- (b) Set forth actions to resolve any impacts that may result across the seams between the Parties' systems due to the integration described in the preceding part (a); and
- (c) Describe results of the joint transmission analysis for the combined transmission systems, as well as explanations, as may be necessary, of the procedures, methodologies, and business rules utilized in preparing and completing the analysis.

9.3.7.2

Coordination of studies required for the development of the Coordinated System Plan will include the following: 1) annual issues review to determine the need for a Coordinated System Plan study described in Section 9.3.7.2.a; and 2) Coordinated System Plan study described in Section 9.3.7.2.b.

- (a) Determine the Need for a Coordinated System Plan Study.
 - (i) On an annual basis, beginning in the fourth quarter of each calendar year and continuing through the first quarter of the following calendar year, the Parties shall perform an annual evaluation of transmission issues identified by each Party including issues from the respective Party's market operations and annual planning processes, or Third-Parties. This annual review of transmission issues will be administered by the JRPC on a mutually agreed to schedule taking into consideration each Party's regional planning cycles.

- (ii) The JRPC's annual review of transmission issues shall include the following steps:
 - a. Exchange of the following information during the fourth quarter of each calendar year or as specified below:
 - i. Regional issues and newly approved regional projects located near the interface or expected to impact the adjacent region;
 - ii. Newly identified regional transmission issues for which there is no proposed solution;
 - iii. Interconnection and long-term firm transmission service requests under coordination by the Parties located near the interface or expected to impact the adjacent region will be exchanged pursuant to sections 9.3.3 and 9.3.4, respectively;
 - iv. Market-to-market historical flowgate congestion between the Parties.
 - b. Joint review by the Parties of regional issues and solutions in January of each calendar year;
 - c. Receipt of Third Party issues in the first quarter of each calendar year;
 - d. Review of regional issues with input from stakeholders at the IPSAC meeting conducted during the first quarter of each calendar year; and
 - e. Decision by the JRPC on whether or not to conduct a Coordinated System Plan study.
- (iii) The JRPC through each Party's respective electronic distribution lists shall provide a minimum of 60 calendar days advance notice of the IPSAC meeting to be held in the first quarter of each year to review identified transmission issues. Stakeholders may identify and submit transmission issues and supporting analysis no later than 30 calendar days in advance of the meeting for consideration by the IPSAC and JRPC.
- (iv) Within 45 days following the annual issues evaluation meeting with IPSAC in the first quarter of the calendar year, the JRPC will determine, taking into consideration input provided by the IPSAC, the need to perform a Coordinated System Plan study. A Coordinated System Plan study shall be initiated by either of the following: (1) each Party in the JRPC votes in favor of performing

the Coordinated System Plan study; or (2) if after two consecutive years in which a Coordinated System Plan study has not been performed, and one Party votes in favor of performing a Coordinated System Plan study. The JRPC shall inform the IPSAC of the decision whether or not to initiate a Coordinated System Plan study within five business days of the JRPC's decision.

- (v) When a Coordinated System Plan study is determined to be necessary, the JRPC shall agree to the start date of the study and identify whether it is a targeted study as defined in this Section at (vi) or a more complex, two-year cycle study as defined in this Section at (vii).
- (vi) If a Coordinated System Plan study includes targeted studies of particular areas, needs or potential expansions to ensure that the coordination of the reliability and efficiency of the Parties' transmission systems, then such targeted studies will be conducted during the first half of the calendar year. In years when the Coordinated System Plan study includes only targeted studies as defined herein, they may be conducted at any time during the calendar year but shall be completed within the calendar year in which they are identified.
- (vii) A Coordinated System Plan study may include more complex, longer duration studies that may involve development of a joint model, as appropriate, to address reliability, market efficiency or public policy needs. Such studies will be conducted on a two-year cycle commencing in the third quarter of the first year of the two-year cycle, if the need is determined by the JRPC. A Coordinated System Plan study scheduled on a two-year cycle will conclude no later than the end of the second year of the two-year cycle.
 - a. For a Coordinated System Plan study scheduled on a two-year cycle, the JRPC will provide notice to the IPSAC in the fourth quarter of the year preceding commencement of the two-year study cycle.
 - b. The first year of the two-year study cycle will consist of model preparation and issue identification and be timed in accordance with each RTO's regional planning processes for model preparation and issue identification. Two-year study cycle activities and their interaction with regional activities are further described in the applicable sections of 9.3.7, particularly in section 9.3.7.2(b)(vii).

(viii) When a Coordinated System Plan study is determined to be necessary by the JRPC, the specific study process steps will depend on the type and scope of the study. The JRPC shall provide a schedule and binding deadlines for each step in the Coordinated System Plan study process no later than 15 days after the IPSAC meeting provided for in Section 9.3.7.2(b)(ii) following the JRPC's decision to initiate such study.

(b) Coordinated System Plan Study Process

(i) Each Party will be responsible for providing the technical support required to complete the analysis for the study. The responsibility for the coordinated study and the compilation of the coordinated study report will alternate between the Parties.

(ii) The JRPC will develop a scope and procedure for the coordinated planning analysis. The scope of the studies will include evaluations of issues resulting from the annual coordinated review and analysis of the Parties transmission issues. The scope and schedule for the Coordinated System Plan study will include the schedule of IPSAC review and input at all stages of the study. Study scope and assumptions will be documented and provided to the IPSAC for review and comment at an IPSAC meeting scheduled no later than 30 days after the decision to conduct a Coordinated System Plan study.

(iii) Ad hoc study groups may be formed as needed to address localized seams issues or to perform targeted studies of particular areas, needs, or potential expansions and to ensure the coordinated reliability and efficiency of the systems. Under the direction of the Parties, study groups will formalize how activities will be implemented. Targeted studies will utilize the best available regional models for transmission and market efficiency analysis.

(iv) The Coordinated System Plan study will consider the identified issues reviewed by the JRPC and IPSAC for further evaluation of potential remedies consistent with the criteria of this Protocol and each Party's criteria. Stakeholder input will be solicited for potential remedies to identified issues, which includes stakeholder and transmission developer proposals for Interregional Projects. The study scope developed under Section 9.3.7.2(b)(ii) will include the schedule for acceptance of such stakeholder Interregional Project proposals including supporting analyses that address issues identified in the JRPC solicitation.

(v) The Parties will document the scope and assumptions including the process and schedule for the conduct of the study. The scope

design will include, as appropriate, evaluation of the transmission system against the reliability criteria, operational performance criteria, economic performance criteria, and public policy needs applicable to each Party.

- (vi) The Parties will use planning models that are developed in accordance with the procedures to be established by the JRPC. If the JRPC develops joint study models, the JRPC will do so consistent with the models and assumptions used for the regional planning cycle most recently completed, or underway, as appropriate. If the Coordinated System Plan study requires transmission evaluations driven by different regional needs (for example transmission that addresses any combination of needs including regional reliability, economics and public policy), then the coordination of studies, models, and assumptions will include the analyses appropriate to each region. The Parties will develop compromises on assumptions when feasible and will incorporate study sensitivities as appropriate when different regional assumptions must be accommodated. Known updates and revisions to models will be incorporated in a comprehensive fashion when new base planning models are available. Prior to the availability of a new comprehensive base model, known updates will be factored in, as necessary, into the review of results. Models will be available for stakeholder review subject to confidentiality and Critical Energy Infrastructure Information (CEII) processes of the Parties. The IPSAC will have the opportunity to provide feedback to the JRPC regarding the study models.
- (vii) When Coordinated System Plan studies are undertaken pursuant to a two-year study cycle defined in this Section at (a)(vii), the following schedule will be followed unless otherwise mutually agreed to by the Parties.
 - a. Parties will provide updated identification of regional issues identified in this Section at (a) by January of the second year of the two-year cycle.
 - i. If MISO conducts a regional Market Congestion Planning Study as part of the MTEP, MISO will use that Market Congestion Planning Study to identify the MISO regional issues that will be incorporated into the Coordinated System Plan study. MISO regional issues identified in a regional Market Congestion Planning Study will be made available for incorporation into the Coordinated System Plan study between November of the first year and January of the second year of the two-year cycle. If MISO does not conduct a regional Market Congestion Planning Study as

part of the MTEP, MISO will use MISO's most recent production cost models to identify regional issues and will provide the regional issues identified for incorporation into the Coordinated System Plan study between November of the first year and January of the second year of the two-year cycle. For matters addressing reliability specifically, MISO will use issues identified in the most recent MTEP report, available annually in December, and the reliability projects, submitted in September of the prior year being considered for inclusion in the current MTEP. MISO will include these projects in the regional issues made available for incorporation into Coordinated System Plan study.

- ii. PJM regional reliability and Market Efficiency analyses will be used to identify regional issues that will be incorporated into the Coordinated System Plan study. Regional reliability analysis proceeds throughout the calendar year identifying PJM issues, including issues near the seam. These seams issues are presented to all stakeholders at the PJM Transmission Expansion Advisory Committee meetings and the PJM competitive window process, if eligible. PJM's long-term economic analysis cycles are conducted during two consecutive calendar years according to the schedule presented to stakeholders at the Transmission Expansion Advisory Committee meetings. The development of the economic model occurs throughout the first three quarters of the first year of the two-year study cycle and is made available for stakeholder review and comment prior to opening PJM's long-term proposal window later in the first year of the two-year study cycle. Both regional and interregional project proposals are submitted through the PJM project proposal windows consistent with Schedule 6, section 1.5.8(c) of the PJM Amended and Restated Operating Agreement. Interregional Project proposals entered into a PJM short-term or long-term proposal window will be analyzed along with PJM regional project proposals. Consistent with Schedule 6, section 1.5.8(d) of the PJM Amended and Restated Operating Agreement, PJM, in consultation with the Transmission Expansion Advisory Committee, shall determine the more efficient or cost effective transmission enhancements and expansions available for incorporation into the Coordinated System Plan study.

- b. MISO and PJM regional models will be made available to the IPSAC for stakeholder review and comment in the first year of the two-year cycle as detailed below:
 - i. MISO will make available its most recent MTEP cycle long-term multi-year power flow models for reliability analysis and multi-year production cost models with multiple economic Futures for economic analysis, annually by November 30.
 - ii. PJM will make available its most recent regional reliability model that is updated annually in the first quarter of each calendar year. PJM's regional economic model is prepared according to the assumptions and schedule as discussed at the Transmission Expansion Advisory Committee meeting scheduled in the first quarter of year one of PJM's long-term regional planning cycle. The economic model is available for stakeholder review and feedback during the third quarter of the first year of PJM's two year planning cycle.
- c. Stakeholder Interregional Project proposals, satisfying applicable regional and interregional requirements, will be accepted by PJM in its project proposal windows as detailed in Schedule 6 of the PJM Amended and Restated Operating Agreement.
- d. Stakeholder identification of Interregional Project proposals satisfying the applicable regional and interregional requirements will be accepted in the MISO MTEP regional process approximately between January through March of the second year of the two-year cycle. A precise timeframe will be provided in each MTEP cycle.
- e. The Parties will evaluate each Interregional Project proposal in its regional process, using the criteria and benefit determination in Sections 9.4.4.1 and 9.4.4.2 and applicable subsections, during the second year of the two-year cycle to determine if a project is eligible for inclusion in the respective regional plans. If recommended by the JRPC per Section 9.3.7.2(b)(xi), an Interregional Project must be presented to the respective Parties' Boards for approval and, if approved, in each Party's regional plan to become an Interregional Project. The Parties shall present the proposed projects, including any proposed Interregional Projects, to their respective Board of Directors or

Managers by December 31 of the second year of the two-year cycle.

- i. In MISO, regional analysis typically occurs between February and September each year. Potential Interregional Projects will be evaluated against the MISO regional criteria and collectively with other potential regional projects to ensure cohesive benefits.
 - ii. In PJM, regional reliability analysis occurs annually. Regional market efficiency analysis occurs biennially. Interregional evaluations will occur in PJM's regional proposal window process as outlined in Section 9.3.7.2(b)(vii)(a)(ii).
- (viii) The IPSAC will have the opportunity to provide input into the development of potential solutions. Feedback by the IPSAC stakeholders shall be provided to each region consistent with each region's regional processes for accepting project proposals. Potential solutions submitted through each region's respective planning processes specific to submitting project proposals shall be communicated between the Parties in a timely manner. The JRPC will be responsible for the screening and evaluation of potential solutions, including evaluating the proposed projects for designation as an Interregional Project pursuant to Section 9.4.4.1. Proposed solution criteria and benefits shall be evaluated by each region pursuant to Sections 9.4.4.1 and 9.4.4.2 and applicable subsections.
- (ix) Transmission upgrades identified through the analyses conducted according to this Protocol and satisfying the applicable Protocol and regional planning requirements will be included in the Coordinated System Plan after the conclusion of the Coordinated System Plan study and applicable regional analyses.
- (x) The JRPC shall produce and submit to the IPSAC for review reports documenting the Coordinated System Plan study, including the transmission issues evaluated, studies performed, solutions considered, and, if applicable, recommended Interregional Projects with the associated cost allocation to the Parties pursuant to Section 9.4.4.2. The review of any proposed allocation of costs under the Coordinated System Plan pursuant to Section 9.4.4 will be accomplished during the periodically scheduled IPSAC meetings held during the course of the Coordinated System Plan study according to this Section 9.3.7.2. In addition, explanations why proposed Interregional Projects did not move forward in the process will be provided in the final Coordinated System Plan

study report to the IPSAC for review. The IPSAC shall be provided the opportunity to provide input to the JRPC on the Coordinated System Plan study reports. Results of, comments and responses to comments on the final Coordinated System Plan study report shall be posted on each Party's website. Fulfillment of the requirements of this subsection will be accomplished through periodically scheduled IPSAC meetings held during the course of the Coordinated System Plan study.

- (xi) The JRPC's recommended Interregional Projects identified in the Coordinated System Plan study shall be reviewed by each Party through its respective regional processes. These regional reviews will be integrated into the interregional process as further described in Sections 9.3 and 9.4. Transmission plans to resolve problems will be identified, included in the respective plans of the Parties and will be presented to the respective Parties' Boards for approval and implementation using each Party's procedures for approval. Critical upgrades for which the need to begin development is urgent will be reviewed by each Party in accordance with their procedures and presented to the Parties' Boards for approval as soon as possible after identification through the coordinated planning process. Other projects identified will be reviewed by each Party in accordance with their procedures and presented to the Parties' Boards for approval in the normal regional planning process cycle as long as this cycle does not delay the implementation of a necessary upgrade. The JRPC shall inform the IPSAC of the outcome of each Party's review of the recommended Interregional Projects.

(c) Targeted Market Efficiency Project Study

The Coordinated System Plan study may include a Targeted Market Efficiency Project study consistent with Section 9.3.7.2(b)(iii). The Targeted Market Efficiency Project study will evaluate, analyze, and determine upgrades to remedy identified historical market-to-market congestion on Reciprocal Coordinated Flowgates on the PJM-MISO market border. Identified issues under this section will be expected to persist and are not expected to be substantially alleviated by system changes planned in the five (5) year planning horizon. Identification of issues will include, but not be limited to, the RTO's determination, based on historical operational information, of any historical flowgate congestion known to be caused by outage conditions. The RTOs will not consider for purposes of a Targeted Market Efficiency Project study, historical congestion on a Reciprocal Coordinated Flowgate caused by outages or will determine a proportionally reduced amount of congestion associated with that flowgate, as appropriate. Any Targeted Market Efficiency Project study initiated by the JRPC under this section will be

conducted under the process defined for a Coordinated System Plan study, except as modified by this section and the following subsections.

- (i) Issues identified in the Targeted Market Efficiency Project study will be reviewed to determine the cause of the market issues, including: (a) the specific limiting elements, (b) verification of the ratings of the limiting elements, (c) whether approved, planned system changes may alleviate the issue, (d) whether outages contribute to all or a portion of the historical congestion, (e) estimates of the cost of upgrading the limiting elements, and (f) whether upgrades to the limiting elements could substantially relieve the constraints;
- (ii) Using the results of the review under subsection (i) and the applicable criteria of Section 9.4, the JRPC will provide to the IPSAC the criteria used to evaluate whether congestion is likely to be persistent. The JRPC will post results of the analysis for input from the IPSAC and will solicit proposals for Targeted Market Efficiency Projects that meet the criteria of Sections 9.3.7.2(c) and 9.4 applicable to a Targeted Market Efficiency Project;
- (iii) The JRPC will determine the list of limiting element upgrades and Targeted Market Efficiency Project proposals to analyze the benefits to PJM and MISO for presentation to and input from the IPSAC;
- (iv) Prior to making the determination outlined in Section 9.3.7.2(c)(vi) below, the JRPC will provide to the IPSAC any additional criteria used to evaluate potential Targeted Market Efficiency Project solutions;
- (v) The JRPC will provide to the IPSAC for input an explanation of:
(a) why the JRPC did not evaluate whether a potential Targeted Market Efficiency Project could economically address congestion on a particular congested Reciprocal Coordinated Flowgate, and
(b) why a potential Targeted Market Efficiency Project that the JRPC evaluated is not recommended to the MISO and PJM Boards for approval;
- (vi) Based on the analysis and stakeholder process conducted consistent with Sections 9.3.7.2(c) and 9.4, the JRPC will determine any Targeted Market Efficiency Project proposals to recommend to their respective Boards for approval; and
- (vii) Solely for the purposes of conducting the Targeted Market Efficiency Project analysis, the regional processes referred to in

Section 9.3.7.2(b) will be the JRPC analysis conducted for the Targeted Market Efficiency Project study according to the scope and procedures developed under Sections 9.3.7.2(b)(ii) and 9.3.7.2(c). The joint JRPC analysis together with the associated stakeholder process will be sufficient for any resulting JRPC recommended Interregional Transmission Projects to be presented for approval to the respective RTOs' Board as described in 9.3.7.2(b)(xi).

9.4 Allocation of Costs of Network Upgrades.

9.4.1 Network Upgrades Associated with Interconnections.

When under Section 9.3.3 it is determined that a generation or merchant transmission interconnection to a Party's system will have an impact on the Affected System such that Network Upgrades shall be made, the upgrades on the Affected System shall be paid for in accordance with the terms and conditions of the Party's OATT.

9.4.2 Network Upgrades Associated with Transmission Service Requests.

When under Section 9.3.4 it is determined that the granting of a long-term firm delivery service request with respect to a Party's system will have an impact on the Affected System such that Network Upgrades shall be made, the upgrades on the Affected System shall be paid for in accordance with the terms and conditions of the Party's OATT.

9.4.3 Network Upgrades Associated with Incremental Auction Revenue Rights Requests.

When under Section 9.3.5 it is determined that the granting of an Incremental ARR request with respect to a Party's system will have an impact on the Affected System such that Network Upgrades shall be made, the upgrades on the Affected System shall be paid for in accordance with the terms and conditions of the Affected System's tariff provisions.

9.4.4 Network Upgrades Under Coordinated System Plan.

The Coordinated System Plan will identify Interregional Projects as: (i) Cross-Border Baseline Reliability Projects ("CBBRP"), (ii) Interregional Reliability Projects, (iii) Interregional Market Efficiency Projects, (iv) Interregional Public Policy Projects, and (v) Targeted Market Efficiency Projects. Consistent with the applicable OATT provisions, the Coordinated System Plan will designate the portion of the Interregional Project Cost for each such project that is to be allocated to each RTO on behalf of its Market Participants. The JRPC will determine an allocation of costs to each RTO for such Network Upgrades based on the procedures described below. The proposed allocation of costs will be reviewed with the IPSAC and the appropriate multi-state entities and posted on the internet web site of the two RTOs. Stakeholder input will be solicited and taken into consideration by the JRPC in arriving at a consensus allocation of costs.

9.4.4.1 Criteria for Project Designation as an Interregional Project:

Interregional Projects must be: (1) physically located in both the MISO region and the PJM region or (2) physically located wholly in one transmission planning region but jointly determined and agreed upon to provide benefits to the other transmission planning region or both transmission planning regions. A project located solely in one region and paid for and benefiting only the adjacent region must meet the individual OATT requirements of the transmission planning region in which the project will be located to be eligible for inclusion in the local RTO's transmission

plan in addition to the project criteria included in section 9.4.4.1.1, 9.4.4.1.2 or 9.4.4.1.3. In addition, an Interregional Project approved by each RTO for inclusion in its regional plan is subject to the construction obligation under each RTO's OATT. For purposes of interregional planning between MISO and PJM, these Interregional Projects will be designated in accordance with the following criteria:

9.4.4.1.1 Cross-Border Baseline Reliability Project Criteria:

Projects that meet all of the following criteria will be designated as CBBRPs:

- (i) by agreement of the JRPC, the project is needed to efficiently meet applicable reliability criteria;
- (ii) the project must be a baseline reliability project as defined under the MISO or PJM Tariffs.

9.4.4.1.2 Interregional Reliability Project Criteria:

An Interregional Reliability Project must:

- (i) be selected both in the MISO and PJM regional planning processes and be eligible for each region's cost allocation process; and
- (ii) by agreement of the JRPC, displace one or more reliability projects in either or both PJM and MISO as defined in their respective tariffs and more efficiently or cost-effectively meet applicable reliability criteria than the displaced reliability project(s).

Through their respective regional planning processes, PJM and MISO respectively will evaluate proposals to determine whether the proposed Interregional Reliability Project(s) addresses reliability needs that are currently being addressed with reliability projects in its regional transmission planning process and, if so, which reliability projects in that regional transmission planning process could be displaced by the proposed Interregional Reliability Project. Reliability projects in the MISO regional transmission planning process include Baseline Reliability Projects and Multi-Value Projects that meet Criterion 3 according to MISO's OATT. MISO and PJM will quantify the benefits of an Interregional Reliability Project based upon the total avoided costs of regional transmission projects included in the then-current regional transmission plan that would be displaced if the proposed Interregional Reliability Project was included in the plan.

9.4.4.1.3 Interregional Market Efficiency Project Criteria:

Interregional Market Efficiency Projects must meet the following criteria:

- (i) is evaluated as part of a Coordinated System Plan or joint study process, as described in Section 9.3.7 of the JOA; and

- (ii) qualifies as an economic transmission enhancement or expansion under the terms of the PJM RTEP and also qualifies as a Market Efficiency Project or a Multi-Value Project that meets Multi-Value Project Criterion 2 or Criterion 3 under the terms of Attachment FF of the MISO OATT (including all applicable threshold criteria), provided that any minimum Project Cost threshold required to qualify a project under either the PJM RTEP or MISO OATT shall apply the Project Cost of the Interregional Market Efficiency Project and not the allocated cost; and

9.4.4.1.3.1 Determination of Benefits to Each RTO from an Interregional Market Efficiency Project:

The RTOs shall jointly evaluate the benefits to the MISO and PJM markets as follows:

- (a) The RTOs shall utilize their respective tariffs' benefit metrics to analyze the anticipated annual economic benefits of construction of a proposed Interregional Market Efficiency Project to Transmission Customers of each RTO.
- (b) The costs applied in the cost allocation calculation pursuant to Section 9.4.4.2.3 shall be the present value, over the same period for which the project benefits are determined, of the annual revenue requirements for the project. The annual revenue requirements for the Interregional Market Efficiency Project are determined from the estimated Interregional Market Efficiency Project installed costs and the fixed charge rate applicable in each respective RTO's regional process.

To determine the present value of the annual benefits and costs, the discount rate shall be based on the transmission owners' most recent after-tax embedded cost of capital weighted by each transmission owner's total transmission capitalization. Each transmission owner shall provide the RTOs with the transmission owner's most recent after-tax embedded cost of capital, total transmission capitalization, and levelized carrying charge rate, including the recovery period. The recovery period shall be consistent with recovery periods allowed by FERC for comparable facilities.

- (c) Using the cost allocated to each RTO pursuant to Section 9.4.4.2.3 of the JOA, each RTO will evaluate the project using its internal criteria to determine if it qualifies as an economic transmission enhancement or expansion under the terms of the PJM RTEP and also qualifies as a market efficiency project under the terms of Attachment FF of the MISO OATT.

9.4.4.1.4 Interregional Public Policy Project Criteria:

Interregional Public Policy Projects must meet the following criteria:

- (i) be selected both in the MISO and PJM regional planning processes and be eligible for each region's cost allocation process; and
- (ii) by agreement of the JRPC, displace one or more regional projects addressing public policy in MISO or one or more public policy projects in PJM as defined in their respective tariffs and more efficiently or cost-effectively meet applicable public policy criteria than the displaced regional project(s).

Through their respective regional planning processes, PJM and MISO respectively will evaluate proposals to determine whether the proposed Interregional Public Policy Project(s) addresses public policy needs that are currently being addressed with public policy projects in its regional transmission planning process and, if so, which public policy projects in that regional transmission planning process could be displaced by the proposed Interregional Public Policy Project. Public policy projects in the MISO regional transmission planning process include Multi-Value Projects that meet Multi-Value Project Criterion 1 under the terms of Attachment FF to MISO's OATT. Public policy projects in the PJM regional transmission planning process include both economic and reliability projects. MISO and PJM will quantify the benefits of an Interregional Public Policy Project based upon the total avoided costs of regional transmission projects included in the then-current regional transmission plan for purposes of cost allocation that would be displaced if the proposed Interregional Public Policy Project was included in the plan.

9.4.4.1.5 Targeted Market Efficiency Project Criteria:

Upgrades associated with Targeted Market Efficiency Projects must meet the following criteria:

- (i) Are evaluated as part of a Coordinated System Plan or joint study process as described in Section 9.3.7.2(c) and demonstrated to have an expectation for substantial relief of identified historical market efficiency congestion issues;
- (ii) Have an estimated in-service date by the third-summer peak season from the year in which the project was approved;
- (iii) Have an estimated installed cost less than \$20 million in study year dollars;
- (iv) Is determined to have expected future congestion relief, due to upgrade of that targeted Reciprocal Coordinated Flowgate, equal to the sum of annual congestion over the four (4) year period after the study year, that is equal

to or greater than the estimated installed capital cost of the upgrade, including appropriate long term costs, in study year dollars, where:

- a. Expected future congestion relief in the amount of the Reciprocal Coordinated Flowgate's anticipated reduction of historical congestion net of any anticipated increases in congestion on nearby flowgates based on the RTO analysis;
 - b. Historical congestion in PJM will be quantified in accordance with PJM OATT, Attachment K-Appendix, Section 5.1. It will include charges associated with Day-ahead and Real-time market congestion for Market Buyers, Generating Market Buyers, and Market Sellers;
 - c. Historical congestions in MISO will be quantified in accordance with MISO OATT, Sections 39.2.9 "Day-Ahead Energy and Operating Reserve Market Process" and 40.2.15 "Real-Time Energy and Operating Reserve Market Process." It will include charges associated with Day-Ahead and Real-Time market congestion for both load and generator buses; and
 - d. Annual congestion is the estimated average historical congestion based on the two historical calendar years prior to the study year.
- (v) Is recommended by the JRPC as a Targeted Market Efficiency Project and approved by each RTO's Board.

9.4.4.1.5.1 Determination of Benefits of Each RTO from a Targeted Market Efficiency Project

The RTO shall jointly evaluate the benefits to the combined markets and to each RTO for each potential Targeted Market Efficiency Project resulting from Section 9.3.7.2(c), according to the following process:

- (i) With input from IPSAC, determine the estimated total installed project capital cost in study year dollars;
- (ii) Compare the estimated expected future congestion relief to the estimated project total installed capital cost in study year dollars. The estimated congestion relief shall equal or exceed the total installed capital cost in study year dollars, where:
 - a. Expected future congestion relief is the sum of each RTO's expected congestion relief, adjusted by market-to-market settlement payments.

9.4.4.2 Interregional Project Benefits and Shares:

The Coordinated System Plan shall designate the share of the Project Cost to be allocated to each RTO as set forth in the following subsections:

9.4.4.2.1 Cost Allocation for Cross-Border Baseline Reliability Projects

- (a) **Method for Thermal Constraints:** The Coordinated System Plan shall designate the share of the Project Cost to be allocated to each RTO based on the relative contribution of the combined Load of each RTO to loading on the constrained facility requiring the need for the CBBRP. The loading contribution will be pre-determined using a joint RTO planning model developed and agreed to by the planning staffs of both RTOs. This model will form the basecase from which reliability needs on the combined systems will be determined for the Coordinated System Plan. The model, adjusted for the conditions driving the upgrade needs, will be used to calculate the DFAX for cost allocation purposes for each RTO, using a source of the aggregate of RTO generation (network resources) for each RTO to a sink of all Loads within that RTO. The DFAX is the appropriate distribution factor for the condition causing the upgrade; OTDF for contingency condition flow criteria violations, and PTDF for normal condition flow criteria violations. The DFAX calculation determines the MW flow impact attributable to each RTO on the constraint requiring the transmission system to be upgraded. The total load of each RTO for the condition modeled is multiplied by the DFAX associated with that RTO to determine the respective MW flow contribution of that RTO to the constraint. The RTOs will quantify the relative impact due to PJM's system and the relative impact due to MISO's system and then will allocate between PJM and MISO the load contributions to the reliability constraint on the system by calculating the relative impacts caused by each RTO. This methodology will determine the extent to which each RTO contributes to the need for a reliability upgrade consistent with the Coordinated System Plan modeling that determined the need for the upgrade. The MISO total load impacts will be allocated to MISO and the PJM total load impacts will be allocated to PJM. PJM and MISO will then reallocate their shares internally in accordance with their respective tariffs. By calculating the impacts in this manner, the RTOs will ensure that the relative contribution of each RTO (including both the aggravating and benefiting contributions of generation and load patterns within each RTO) to the need for a particular upgrade, is appropriately captured in the ensuing allocations, and that the allocation is consistent with the Coordinated System Plan modeling that determined the need for the upgrade.
- (b) **Method for Non-Thermal Constraints:** The JRPC will establish an interface, comprised of a number of transmission facilities, to serve as a surrogate for allocation of cost responsibility for non-thermal constraints. The interface will be established such that the aggregate flow on the

interface best represents the non-thermal constraint which the CBBRP is proposed to alleviate. Allocation of cost responsibility for the non-thermal constraint will be determined by applying the procedures described in this Section to the interface serving as a surrogate for the constraint.

- (c) **Method for Projects that Also Qualify As Interregional Reliability Projects:** For an Interregional Project that meets the criteria of both a CBBRP under Section 9.4.4.1.1 and an Interregional Reliability Project under Section 9.4.4.1.2, the cost will be allocated in accordance with the methodology set forth in Section 9.4.4.2.2.

9.4.4.2.2 Cost Allocation for an Interregional Reliability Project:

The cost of an Interregional Reliability Project, selected in the regional transmission plans of both PJM and MISO, will be allocated as follows:

- (i) The share of the costs an Interregional Reliability Project allocated to a region will be determined by the ratio of the present value(s) of the estimated costs of such region's displaced reliability projects as agreed to by the RTOs to the total of the present value(s) of the estimated costs of the displaced reliability projects in both regions that have selected the Interregional Reliability Project in their respective regional plans.
- (ii) For purposes of this subsection, a displaced reliability project's estimated costs shall be determined by PJM and MISO in accordance with their respective procedures for defining project estimated costs. Notwithstanding the foregoing, both RTOs shall work to ensure that their cost estimates for displaced reliability projects are determined in a similar manner. The applicable discount rate(s) used for the MISO region shall be the discount rate proposed by the Transmission Owner that produces the cost estimate for the proposed project. The applicable discount rate(s) used for the PJM region shall be the discount rate included in the assumptions reviewed by the PJM Board of Managers each year for use in the economic planning process.
- (iii) Costs allocated to each region shall be further allocated within each region pursuant to the cost allocation methodology contained in each region's respective regional transmission planning process.

9.4.4.2.3 Cost Allocation for an Interregional Market Efficiency Project:

For Interregional Market Efficiency Projects that meet all of the qualifications in Section 9.4.4.1.3, the applicable project costs shall be allocated to the respective RTOs in proportion to the net present value of the total benefits calculated for each RTO pursuant to each RTO's respective tariff.

9.4.4.2.4 Cost Allocation for an Interregional Public Policy Project:

The cost of an Interregional Public Policy Project, selected in the regional transmission plans of both PJM and MISO, will be allocated as follows:

- (i) The share of the costs for an Interregional Public Policy Project allocated to a region will be determined by the ratio of the present value(s) of the estimated costs of such region's displaced public policy projects to the total of the present value(s) of the estimated costs of the displaced public policy projects in both regions that have selected the Interregional Public Policy Project in their respective regional plans.
- (ii) For purposes of this subsection, a displaced regional public policy project's estimated costs shall be determined by PJM and MISO in accordance with their respective procedures for defining project estimated costs. Notwithstanding the foregoing, both RTOs shall work to ensure that their cost estimates for displaced public policy projects are determined in a similar manner. The applicable discount rate(s) used for the MISO region shall be the discount rate developed by MISO for cost estimates for projects under review by the MISO Board of Directors. The applicable discount rate(s) used for the PJM region shall be the discount rate included in the assumptions reviewed by the PJM Board of Managers each year for use in the economic planning process.
- (iii) Costs allocated to each region shall be further allocated within each region pursuant to the cost allocation methodology contained in each region's respective regional transmission planning process.

9.4.4.2.5 Cost Allocation for a Targeted Market Efficiency Project:

For Targeted Market Efficiency Projects that meet all of the qualifications in Section 9.4.4.1.5, the applicable project costs shall be allocated to the respective RTOs in proportion to the determination of expected future congestion relief for each RTO calculated pursuant to that Section.

9.4.4.3 Cost Recovery of Interregional Allocation Shares:

The cost recovery of any share of cost of an Interregional Project allocated to either RTO shall be recovered by each RTO according to the applicable tariff provisions of the RTO to which such cost recovery is allocated.

9.4.4.4 Transmission Owners Filing Rights:

Nothing in this Section 9.4 shall affect or limit any Transmission Owners filing rights under Section 205 of the Federal Power Act as set forth in the applicable Tariffs and applicable agreements.

9.4.4.5 Amendments:

Interregional Agreements --> MISO-JOA --> MISO-JOA ARTICLE IX - COORDINATED REGIONAL TRANSMISSION EXPA -->
MISO-JOA 9.4 Allocation of Costs of Network Upgrades

The RTOs shall amend Article IX of this Agreement in accordance with the applicable tariffs and/or agreements.

9.5 Agreement to Enforce Duties to Construct and Own.

To obtain Network Upgrades under this Article IX, PJM will enforce obligations to construct and own or finance enhancements or additions to transmission facilities in accordance with the Transmission Owners Agreement, PJM Interconnection, L.L.C. First Revised Rate Schedule FERC No. 29, the West Transmission Owners Agreement, PJM Interconnection, L.L.C. Rate Schedule FERC No. 33, as either may be amended or restated from time to time, and MISO will enforce obligations to construct enhancements or additions to transmission facilities in accordance with the Agreement of Transmission Facilities Owners To Organize The Midcontinent Independent System Operator, Inc., A Delaware Non-Stock Corporation, MISO FERC Electric Tariff, First Revised Rate Schedule No. 1, as it may be amended or restated from time to time.

ARTICLE X
JOINT CHECKOUT PROCEDURES

10.1 Scheduling Checkout Protocols.

10.1.1 Scheduling Protocols.

Each Party will leverage technology to perform electronic approvals of schedules and to perform electronic checkouts. The Parties will follow the following scheduling protocols:

10.1.1.1

Each Party, acting as the scheduling agent for its respective BAs, will conduct all checkouts with first tier BAs. A first tier BA is any BA that is directly connected to any Party's members' BA or any BA operated by an independent transmission company.

10.1.1.2

The Parties will require all schedules, other than reserve sharing or other emergency events, to be tagged in accord with the NERC tagging standard. For reserve sharing and other emergency schedules that are not tagged, the Parties will enter manual schedules after the fact into their respective scheduling systems to facilitate checkout between the Parties.

10.1.1.3

When there is a scheduling conflict, the Parties will work in unison to modify the schedule as soon as practical. If there is a scheduling conflict that is identified before the schedule has started, then both Parties will make the correction in real-time and not wait until the quarter hour. If the schedule has already started and one Party identifies an error, then the Parties will make the correction at the earliest quarter hour increment. If a scheduling conflict cannot be resolved between the Parties (but the source and sink have agreed to a MW value), then the Parties will both adjust their numbers to that same MW value. If source and sink are unable to agree to a MW value, then the previously tagged value will stand for both Parties.

10.1.1.4

For BAs or associated scheduling agents that do not use the respective Parties' electronic scheduling interfaces, the Parties will contact entities by telephone to perform checkouts. When performing checkouts by telephone, each entity will verbally repeat the numerical NSI value to ensure accuracy.

10.1.1.5

The Parties will perform the following types of checkouts:

- (a) Pre-schedule (day-ahead) daily between 1600 and 2000 (Eastern Prevailing Time) hours:
 - (i) Intra-hour checkout/schedule confirmation will occur as required due to intra-hour scheduled changes.

- (b) Hourly Before the Fact (real-time):
 - (i) Checkout for the next hours shall be net scheduled. Import and export totals may also be verified in addition to NSI if it is deemed necessary by either party. The Parties may checkout individual schedules if deemed necessary by either party.
 - (ii) Checkout for the top of the next hour is performed during the last half of the current hour.
- (c) Daily after the fact checkout shall occur no later than ten (10) business days after the fact (via email or mutually agreed upon method).
- (d) Monthly after the fact checkout shall occur no later than one (1) month after the fact (via phone or mutually agreed upon method).

10.1.1.6

The Parties will require that each of these checkouts be performed with first tier BAs. If a checkout discrepancy is discovered, the Parties will use the NERC tag to determine where the discrepancy exists. The Parties will require any entity that conducts business within its RC Area to checkout with the applicable Party using NERC tag numbers; special naming convention used by that entity or other naming conventions given to schedules by other entities will not be permitted.

ARTICLE XI
ADDITIONAL COORDINATION PROVISIONS

11.1 Application of Congestion Management Process.

The Parties have agreed to certain operating protocols under this Agreement to ensure system reliability and efficient market operations as systems exist and are contemplated as of the Effective Date. These protocols include the Congestion Management Process and applicable NERC reliability plans. As addressed in Section 3.1, the Parties expect that these systems and the operating protocols applicable to these systems will change and revisions to this Agreement will be required from time to time.

11.2 Additional Provisions Concerning Market-to-Market.

11.2.1 LMP Calculation Consistency.

The Parties agree to ensure that LMP signals meet certain common criteria in order to achieve maximum benefits to competition from the Joint and Common Market. In particular, the Parties agree that dispatch in both markets will be performed under a nodal pricing regime and that settlement will be based, in part, on the resulting LMPs. Given the importance of the individual LMPs, the pricing methodologies employed will result in prices that meet certain common criteria at all relevant physical interfaces between the two markets. The Parties' goal will be that the respective prices calculated by both Parties for these interfaces will be identical. Therefore, to the extent that such prices are not identical, the Parties agree to work in good faith to resolve the reasons for the differences in order to send the most consistent economic signals reasonably possible to all market participants.

The Parties further agree that the LMP formulation will be such that the optimal solution will be very close to the current system operating condition. Inputs into the Locational Marginal Pricing program will be the flexible generating units from the LMP Preprocessor, actual generation, load and system topology from the State Estimator, and binding constraints from the LMP Contingency Processor. The Parties agree to work in good faith to reach resolution on the frequency of the calculation of the prices. Additionally, the Parties agree that any changes to the pricing methodology will be coordinated across the two markets to maintain consistency.

11.2.2 Coordination Processes.

As the MISO market and the PJM market have evolved over time, it has become critical to coordinate the LMP-based congestion management procedures between the two markets. The market-to-market transmission congestion processes and the LMP at the market border points must be coordinated in order to efficiently manage interregional power flows. This coordination process will ensure appropriate LMP values at the market borders and will eliminate potential inefficiencies and gaming opportunities that otherwise could be caused by uncoordinated congestion management between the adjacent markets.

11.2.3 Market-to-Market Coordination Process.

The fundamental philosophy of the market-to-market transmission congestion coordination process is to allow any transmission constraints that are significantly impacted by generation dispatch changes in both markets to be jointly managed in the security-constrained economic dispatch models of both Parties. This joint management of transmission constraints near the market borders will provide a more efficient and lower cost transmission congestion management solution and will also provide coordinated pricing at the market boundaries.

This market-to-market coordination process builds upon the Parties' market-to-non-market coordination process, as described in the "Congestion Management Process" document. The set of transmission Flowgates in each market that can be significantly impacted by the economic dispatch of generation serving load in the adjacent market is identified as the set of RCFs. These RCFs are then monitored to measure the impact of Market Flows and loop flows from adjacent regions. The "Congestion Management Process" document provides a framework for calculating the resulting powerflow impacts resulting from the market-based economic dispatch in one region on the transmission facilities in an adjacent region and vice versa (Market Flow impacts). In addition, the "Congestion Management Process" document describes how the Market Flow impacts will be managed on an interregional basis within the existing IDC to enhance the effectiveness of the NERC interregional congestion management process. Lastly, the "Congestion Management Process" document also describes a process for calculating flow entitlement for network and firm transmission utilization in one region on the RCFs in an adjacent region.

The market-to-market coordination process builds on the processes, as described above, by adapting the coordination, as appropriate, to the conditions that will prevail after the Parties' markets are implemented in the Midwest. In addition, there is a continuing need to define the flow entitlement for network and firm transmission utilization in one region on the RCFs in an adjacent region.

The Parties shall utilize the Interregional Coordination Process on all market-to-market Flowgates that experience congestion. The Party that is responsible for a Flowgate will initiate and terminate the market-to-market process with the other Party. Anytime the Party that is responsible for a Flowgate is binding on that Flowgate to manage congestion, the responsible Party will implement the market-to-market process to utilize the more cost effective generation between the two markets to manage the congestion. The only exception when the market-to-market process is not used will occur when a market-to-market Flowgate is being used as a substitute Flowgate for another limit that is not a market-to-market Flowgate.

The market-to-market process described in the Interregional Coordination Process will normally be performed as needed in the real-time market, however if the need for congestion relief assistance is predictable on a day-ahead basis, the foregoing process will be implemented in the day-ahead market.

The market-to-market settlement process that is applied to both real-time and day-ahead usage is described in the Interregional Coordination Process.

11.2.4 Settlement of Interregional Transactions (via Proxy Buses).

In order for the market-to-market coordination to function properly, the proxy bus models for the Parties must be coordinated to the same level of granularity. The proxy bus modeling approaches must be the same at the market borders.

Further details regarding the Interregional Coordination Process are described in Attachment 3 of this Agreement.

11.2.5 Auction Revenue Rights Allocation and Financial Transmission Rights Auction Coordination.

The allocation ARR and auction of FTR products in each marketplace must recognize the Flowgate entitlement that exists in adjacent markets. The ARR allocation/FTR auction model will essentially contain exactly the same level of detail for adjacent regions as the day-ahead market model and the real-time market model. Each Party will allocate ARRs or auction FTRs to the eligible market participants subject to a clearing process that determines the amount of transmission capability that exists to support the FTRs/ARRs.

The ARR allocation/FTR auction clearing process for each Party will model that Party's flow entitlement on the transmission Flowgates in the adjacent region as the powerflow limit that must be respected in the ARR allocation/FTR auction process. The transmission Flowgates in each Party will be modeled in the clearing process at a capability value equal to the Flowgate rating minus the flow entitlement that exists for flows from the adjacent market. In this way, the ARR allocation/FTR awards across both Parties will recognize the reciprocal transmission utilization that exists for eligible market participants in both markets.

11.2.6 Evolution of the Market-to-Market Coordination Process.

Nothing in this Agreement will preclude the Parties from further evolving their market-to-market coordination process in conjunction with input from their respective market monitors.

11.2.7 Coordinated Emergency Generation Redispatch.

The Parties shall follow a least-cost dispatch protocol in response to system emergencies that will mitigate or stabilize the system emergency in appropriate time to prevent IROL violation, and the costs thereof shall be reflected in, and compensated through, relative LMP values. However, in the event that costs not cognizable under LMP are incurred, the Party within which the affected resources are located shall reimburse such resource for direct incremental cost, subject to inter-RTO reimbursement in the event that the costs incurred by one Party were caused by a system emergency in the other Party.

Additionally, in the absence of the need to coordinate congestion or address a system emergency, a Party shall be entitled to request that the other Party dispatch a generation unit, subject to the Parties' agreement with respect to compensation for the dispatch.

11.3 Pseudo-Tie Coordination.

11.3.1 Authorities for Pseudo-Tied Units into PJM.

MISO will be the Native RC, responsible for transmission related congestion (SOLs and IROLs) on the transmission system where the pseudo-tied units are physically connected. PJM will be the Attaining RC, responsible for the commitment and dispatch of the pseudo-tied units physically located within the MISO RC footprint.

Transmission Operators within the MISO RC footprint will be the Native TOP for the pseudo-tied units that are physically located within their respective TOP zones.

PJM will be the Attaining BA, Attaining TOP, and Attaining RC for all of the MW of such generation units that are pseudo-tied out of the MISO BAA and into the PJM BAA.

11.3.2 Authorities for Pseudo-Tied Units into MISO.

PJM will be the Native RC, responsible for transmission related congestion (SOLs and IROLs) on the transmission system where the pseudo-tied units are physically connected. MISO will be the Attaining RC responsible for commitment and dispatch of the pseudo-tied units physically located within the PJM RC footprint.

PJM will be the Native TOP of pseudo-tied units that are physically located within its TOP zones.

MISO will be the Attaining BA and Attaining RC for all of the MWs of such generating units that are pseudo-tied out of the PJM BAA and into the MISO BAA.

11.3.3 Partial Pseudo-Tie.

If only a portion of the installed capacity of a generating unit is pseudo-tied out of the Native Balancing Authority and into the Attaining Balancing Authority such that a unique share resides in each Balancing Authority, the Attaining Balancing Authority will send dispatch instructions to the portion of the resource committed to the Attaining Balancing Authority. The Native Balancing Authority will send dispatch instructions to the portion of the resource committed to the Native Balancing Authority.

11.3.4 Station Service.

PJM and MISO agree that the entity pseudo-tying the unit from the Native Balancing Authority Area to the Attaining Balancing Authority Area will obtain station service for the pseudo-tied unit in accordance with the rules of the Native Balancing Authority.

11.3.5 Non-recallability.

PJM and MISO agree that the pseudo-tied unit is non-recallable to the extent it is committed as a PJM Generation Capacity Resource or MISO Capacity Resource for a Delivery Year to ensure that the unit will not be directed to serve load in the Native Balancing Authority Area at a time when the Attaining Balancing Authority Area requires the output of the unit. However, a pseudo-tied unit may be committed, de-committed or re-dispatched, for local SOL or IROLs by the Native RC per the PJM – MISO Pseudo-Tied Units Operating Procedure or Safe Operating Mode. If time permits, any instructions to a pseudo-tied unit will go through the Attaining Balancing Authority. PJM and MISO agree that any energy produced by the pseudo-tied unit during the transmission emergency will be delivered to the Attaining BA.

11.3.6 Losses.

PJM and MISO agree that the entity seeking to Pseudo-Tie will be responsible for loss compensation to deliver its energy to or receive its energy from the Native Balancing Authority to the Attaining Balancing Authority. Pseudo-tie value(s) will be calculated net of losses at the high voltage side of the generator step up transformer.

11.3.7 Suspension.

PJM and MISO reserve the right to suspend a pseudo-tie if the entity that pseudo-tied the unit no longer satisfies the PJM or MISO requirements for pseudo-ties, criteria for participation in the Attaining Balancing Authority's markets as an external resource, or other applicable requirements (as detailed in respective PJM and MISO tariffs and manuals), if the entity that pseudo-tied the unit commits a material default under its pseudo-tie agreement or has failed to cure any breach of such agreement, or if PJM or MISO reasonably determines that the pseudo-tie poses a risk to system reliability or risk of violation of established reliability criteria, by giving immediate notice of suspension. Suspension shall be coordinated between PJM and MISO and may include but not be limited to decommitting the unit or requiring the unit to follow manual dispatch instructions. During any suspension period, the pseudo-tied generating unit shall remain under the operational control of the Attaining Balancing Authority and shall not be under the operational control of Native Balancing Authority.

11.3.8 Termination.

PJM and MISO shall each have the right to terminate a pseudo-tie between their respective Balancing Authorities in accordance with their respective tariffs and the notice provisions below. PJM and MISO shall coordinate the change to the pseudo-tie status.

11.3.9 Notice of Termination.

Notification regarding termination of a pseudo-tie between the MISO Balancing Authority Area and the PJM Balancing Authority Area shall be provided as follows:

- (a) The Balancing Authority seeking to terminate the pseudo-tie of a PJM Generation Capacity Resource, for any reason other than the reasons described in subsection (b) below, shall give the other Balancing Authority and the entity that pseudo-tied the unit at least forty-two (42) months written notice prior to the commencement of a PJM Delivery Year, for any reason, subject to receiving all necessary regulatory approvals for such termination.
- (b) The Balancing Authority seeking to terminate the pseudo-tie of any Generation Resource for the reasons described in this subsection (b) shall give the other Balancing Authority and the entity that pseudo-tied the unit at least sixty (60) days' written notice of such termination request.
 - (i) The entity that pseudo-tied the unit into the Attaining BA no longer satisfies the Attaining BA's or Native BA's requirements for pseudo-ties, or
 - (ii) The entity that pseudo-tied the unit into the PJM BA no longer satisfies PJM's criteria for participation in its markets for an external resource, or
 - (iii) The entity that pseudo-tied the unit into the Attaining BA commits a material default of the terms of the pseudo-tie agreement with Attaining BA or Native BA, or
 - (iv) The entity that pseudo-tied the unit into the Attaining BA has failed to cure any breach of such agreement, or
 - (v) The Attaining BA or Native BA experiences an emergency or other unforeseen, adverse condition that may impair or degrade the reliability of the transmission system such as, but not limited to, a transmission constraint that impairs the reliability of the Attaining BA's or Native BA's transmission system or a condition that causes the pseudo-tied unit to become undeliverable.
- (c) A notice of cancellation will be filed with the Commission, if required. Termination shall be effective as of the date specified in the notification of cancellation, or following acceptance by the Commission, if required.

ARTICLE XII
EFFECTIVE DATE

12.1

The Parties agree to file this Agreement jointly with FERC on or before December 31, 2003 and to cooperate with each other as necessary and appropriate to facilitate such filing. In that filing, the Parties shall request FERC to approve an effective date 60 days after filing (“Effective Date”).

ARTICLE XIII
JOINT RESOLUTION OF MARKET MONITOR ISSUES

13.1 Market Monitoring Protocols.

In addition to, as otherwise already provided in this Agreement, the Parties agree to address the matters raised and recommendations contained in a filing that the Parties' respective Market Monitors made on July 28, 2003 in Docket No. EL03-35-002, in response to the FERC order issued in *Midwest Independent Transmission System Operator, Inc.*, 103 FERC ¶ 61,210.

ARTICLE XIV
COOPERATION AND DISPUTE RESOLUTION PROCEDURES

14.1 Administration of Agreement.

The ISC shall perform the following with respect to this Agreement:

- (a) Meet no less than once annually to determine whether changes to this Agreement would enhance reliability, efficiency, or economy and to address other matters concerning this Agreement as either Party may raise.
- (b) Conduct additional meetings upon Notice given by either Party, provided that the Notice specifies the reason for the requested meeting.
- (c) Establish task forces and working committees as appropriate to address any issues a Party may raise in furtherance of the objectives of this Agreement.
- (d) Conduct dispute resolution in accordance with this Article.
- (e) Initiate process reviews at the request of either Party for activities undertaken in the performance of this Agreement.

The ISC shall have the authority to make decisions on issues that arise during the performance of the Agreement based upon consensus of the Parties' representatives thereto.

14.2 Dispute Resolution Procedures.

The Parties shall attempt in good faith to achieve consensus with respect to all matters arising under this Agreement and to use reasonable efforts through good faith discussion and negotiation to avoid and resolve disputes that could delay or impede either Party from receiving the benefits of this Agreement. These dispute resolution procedures apply to any dispute that arises from either Party's performance of, or failure to perform, this Agreement and which the Parties are unable to resolve prior to invocation of these procedures.

14.2.1 Step One.

In the event a dispute arises, a Party shall give written notice of the dispute to the other Party. Within ten (10) days of such Notice, the ISC shall meet and the Parties will attempt to resolve the Dispute by reasonable efforts through good faith discussion and negotiation. Each Party shall also be permitted to bring no more than two (2) other individuals to ISC meetings held under this step as subject matter experts; however, all representatives must be employees of the Party they represent. In addition, if the Parties agree that legal representation would be useful in connection with a meeting, each Party may bring two (2) attorneys (who need not be employees of the Party they represent). In the event the ISC is unable to resolve within twenty (20) days of such Notice, either Party shall be entitled to invoke Step 2.

14.2.2 Step Two.

A Party may invoke Step 2 by giving Notice thereof to the ISC. In the event a Party invokes Step 2, the ISC shall, in writing, and no later than five (5) days after the Notice, refer the dispute in writing to the Parties' Presidents for consideration. The Parties' Presidents shall meet in person no later than fourteen (14) days after such referral and shall make a good faith effort to resolve the dispute. The Parties shall serve upon each other, written position papers concerning the dispute, no later than forty-eight (48) hours in advance of such meeting. In the event the Parties' Presidents fail to resolve the dispute, either Party shall be entitled to invoke Step Three.

14.2.3 Step Three.

Upon the demand of either Party, the dispute shall be referred to the FERC's Office of Dispute Resolution for mediation, and upon a Party's determination at any point in the mediation that mediation has failed to resolve the dispute, either Party may seek formal resolution by initiating a proceeding before the FERC.

14.2.4 Exceptions.

In the event of disputes involving Confidential Information, infringement or ownership of Intellectual Property or rights pertaining thereto, or any dispute where a Party seeks temporary or preliminary injunctive relief to avoid alleged immediate and irreparable harm, the procedures stated in Section 14.2 and its subparts shall apply but shall not preclude a Party from seeking such temporary or preliminary injunctive relief, provided, that if a Party seeks such judicial relief but fails to obtain it, the Party seeking such relief shall pay the reasonable attorneys' fees and costs of the other Party incurred with respect to opposing such relief.

**ARTICLE XV
RELATIONSHIP OF THE PARTIES**

15.1 Relationship Between this Agreement and Joint and Common Market Agreement.

The Parties agree that execution of this Agreement will further enable the Parties to address many of the specific tasks that are required prior to the creation of a joint and common market between the Parties. Specifically, Articles III through XI of this Agreement detail certain assignments that may pertain to the joint and common market. To ensure efficient handling of tasks hereunder and under the Joint and Common Market Agreement, the Parties hereby agree as follows:

15.1.1 Avoiding Duplication of Efforts.

The Parties agree that to the extent that the tasks specified in Articles III through XI of this Agreement are duplicative of projects being pursued under the Joint and Common Market Agreement, the Parties will utilize this Agreement to pursue those assignments to minimize duplicative efforts. The Parties therefore agree that the Joint and Common Market Agreement will be deemed to be superseded by this Agreement only to the extent necessary to accomplish the assignments in Articles III through XI.

15.1.2 Making Necessary Amendments to the Joint and Common Market Agreement.

The Parties agree to amend the Joint and Common Market Agreement to carry out the purposes of Section 15.1.1 within thirty (30) days after the Effective Date of this Agreement, to the extent amendment may be required under the terms of the Joint and Common Market Agreement.

ARTICLE XVI

ACCOUNTING AND ALLOCATION OF COSTS OF JOINT OPERATIONS

16.1 Revenue Distribution.

This Agreement does not modify any FERC approved agreement between a Party and the owners of the transmission facilities over which the Party exercises control with regard to revenue distribution. All distribution of revenue received under this Agreement shall be distributed by the Party receiving such revenue in accordance with the terms of such Party's agreement with the transmission owners.

16.2 Billing and Invoicing Procedures.

Except as specifically set forth in this Agreement, each Party shall render invoices to the other Party for amounts due under this Agreement in accordance with its customary billing practices (or as otherwise agreed between the Parties) and payment shall be due in accordance with the invoicing Party's customary payment requirements (unless otherwise agreed). All payments shall be made in immediately available funds payable to the invoicing Party by wire transfer pursuant to instructions set out by the Parties from time to time. Interest on any amounts not paid when due shall be calculated in accordance with the methodology specified for interest on refunds in the Commission's regulations at 18 C.F.R. § 35.19a(a)(2)(iii).

16.3 Access to Information by the Parties.

Each Party grants the other Party, acting through its officers, employees and agents such access to the books and records of the other as is necessary to audit and verify the accuracy of charges between the Parties under this Agreement. Such access to records shall be at the location of the Party whose books and records are being reviewed pursuant to this Agreement and shall occur during regular business hours.

ARTICLE XVII RETAINED RIGHTS OF PARTIES

17.1 Parties Entitled to Act Separately.

This Agreement does not create or establish, and shall not be construed to create or establish, any partnership or joint venture between the Parties. This Agreement establishes terms and conditions solely of a contractual relationship, between two independent entities, to facilitate the achievement of the joint objectives described in the Agreement. The contractual relationship established hereunder implies no duties or obligations between the Parties except as specified expressly herein. All obligations hereunder shall be subject to and performed in a manner that complies with each Party's internal requirements; provided, however, this sentence shall not limit either Party's payment obligation under Article XVI or indemnity obligation under Section 18.3.1 or Section 18.3.2, respectively.

17.2 Agreement to Jointly Make Required Tariff Changes to Implement Agreement.

The Parties agree that they shall cooperate in good faith in the filing of any Section 205 filings before FERC that may be required to implement the terms of this Agreement, including revisions to a Party's OATT as necessary to implement Sections 6.2, 6.3, 9.4.1, and 9.4.2 of this Agreement. Whenever practicable, the Parties agree that they shall make simultaneous filings with FERC concerning such tariff filings.

ARTICLE XVIII
ADDITIONAL PROVISIONS

18.1 Confidentiality.

18.1.1 Definition.

The term “Confidential Information” shall mean: (a) all information, whether furnished before or after the mutual execution of this Agreement, whether oral, written or recorded/electronic, and regardless of the manner in which it is furnished, that is marked “confidential” or “proprietary” or which under all of the circumstances should be treated as confidential or proprietary; (b) any information deemed confidential under some other form of confidentiality agreement or tariff provided to a Party by a generator; (c) all reports, summaries, compilations, analyses, notes or other information of a Party hereto which are based on, contain or reflect any Confidential Information; (d) applicable material deemed Confidential Information pursuant to the PJM Data Confidentiality Regional Stakeholder Group, and (e) any information which, if disclosed by a transmission function employee of a utility regulated by the FERC to a market function employee of the same utility system, other than by public posting, would violate the FERC’s Standards of Conduct set forth in 18 C.F.R. § 37, *et seq.* and the Parties’ Standards of Conduct on file with the FERC.

18.1.2 Protection.

During the course of the Parties’ performance under this Agreement, a Party may receive or become exposed to Confidential Information. Except as set forth herein, the Parties agree to keep in confidence and not to copy, disclose, or distribute any Confidential Information or any part thereof, without the prior written permission of the issuing Party. In addition, each Party shall ensure that its employees, its subcontractors and its subcontractors’ employees and agents to whom Confidential Information is exposed agree to be bound by the terms and conditions contained herein. Each Party shall be liable for any breach of this Section by its employees, its subcontractors and its subcontractors’ employees and agents.

This obligation of confidentiality shall not extend to information that, at no fault of the recipient Party, is or was (1) in the public domain or generally available or known to the public; (2) disclosed to a recipient by a third party who had a legal right to do so; (3) independently developed by a Party or known to such Party prior to its disclosure hereunder; and (4) which is required to be disclosed by subpoena, law or other directive or a court, administrative agency or arbitration panel, in which event the recipient hereby agrees to provide the issuing Party with prompt Notice of such request or requirement in order to enable the issuing Party to (a) seek an appropriate protective order or other remedy, (b) consult with the recipient with respect to taking steps to resist or narrow the scope of such request or legal process, or (c) waive compliance, in whole or in part, with the terms of this Section. In the event that such protective order or other remedy is not obtained, or that the issuing Party waives compliance with the provisions hereof, the recipient hereby agrees to furnish only that portion of the Confidential Information which the recipient’s counsel advises is legally required and to exercise best efforts to obtain assurance that confidential treatment will be accorded to such Confidential Information.

18.1.3 Confidential Data Exchange.

The Parties agree that various components of the data exchanged under Article IV, are Confidential Information and that, in addition to the protections of Confidential Information provided under Section 18.1.2

- (a) The Party receiving the Confidential Information shall treat the information in the same confidential manner as its Governing Documents require it treat the confidential information of its own members and market participants.
- (b) The receiving Party shall not release the producing Party's Confidential Information until expiration of the time period controlling the producing Party's disclosure of the same information, as such period is described in the producing Party's Governing Documents from time to time. As of the Effective Date, this period is six (6) months with respect to bid or pricing data and seven (7) calendar days for transmission data after the event ends.
- (c) All other prerequisites applicable to the producing Party's release of such Confidential Information have been satisfied as determined by the producing Party.
- (d) Notwithstanding anything to the contrary in this Agreement, EMS models and the data used for current and future EMS modeling exchanged pursuant to §4.1 may be released to each party's Transmission Owners for operational or reliability compliance purposes. Each party shall require their Transmission Owners to maintain EMS models and the related data as confidential in a manner consistent with or superior to the terms and conditions contained therein.

18.2 Protection of Intellectual Property.

18.2.1 Unauthorized Transfer of Third-Party Intellectual Property.

In the performance of this Agreement, no Party shall transfer to the other Party any Intellectual Property the use of which by the other Party would constitute an infringement of the rights of any third party. In the event such transfer occurs, whether or not inadvertent, the transferring Party shall, promptly upon learning of the transfer, provide Notice to the receiving Party and upon receipt of Notice shall take reasonable steps to avoid claims and mitigate losses.

18.2.2 Intellectual Property Developed Under this Agreement.

In the event in the course of performing this Agreement the Parties mutually develop any new Intellectual Property that is reduced to writing, the Parties shall negotiate in good faith concerning the ownership and licensing thereof.

18.3 Indemnity.

18.3.1 Indemnity of MISO.

PJM will defend, indemnify and hold MISO harmless from all actual losses, damages, liabilities, claims, expenses, causes of action, and judgments (collectively “Losses”), brought or obtained by third parties against MISO, only to the extent such Losses arise directly from:

- (a) Gross negligence, recklessness, or willful misconduct of PJM or any of PJM’s agents or employees, in the performance of this Agreement, except to the extent the Losses arise (i) from gross negligence, recklessness, willful misconduct or breach of contract or law by MISO or any of MISO’s agents or employees, or (ii) as a consequence of strict liability imposed as a matter of law upon MISO or MISO’s agents or employees;
- (b) Any claim that PJM violated any copyright, patent, trademark, license, or other intellectual property right of a third party in the performance of this Agreement;
- (c) Any claim arising from the transfer of Intellectual Property in violation of Section 18.2.1; or
- (d) Any claim that PJM caused bodily injury to an employee of MISO due to negligence, recklessness, or willful conduct of PJM.

18.3.2 Indemnity of PJM.

MISO will defend, indemnify and hold PJM harmless from all actual losses, damages, liabilities, claims, expenses, causes of action, and judgments (collectively “Losses”), brought or obtained by third parties against PJM, only to the extent such Losses arise directly from:

- (a) Gross negligence or recklessness, or willful misconduct of MISO or any of MISO’s agents or employees, in the performance of the Agreement, except to the extent the Losses arise (i) from gross negligence, recklessness, willful misconduct or breach of contract or law by PJM or any of PJM’s agents or employees, or (ii) as a consequence of strict liability imposed as a matter of law upon PJM or PJM’s agents or employees;
- (b) Any claim that MISO violated any copyright, patent, trademark, license, or other intellectual property right of a third party in the performance of this Agreement;
- (c) Any claim arising from the transfer of Intellectual Property in violation of Section 18.2.1; or

- (d) Any claim that MISO caused bodily injury to an employee of PJM due to negligence, recklessness, or willful conduct of MISO.

18.3.3 Damages Limitation.

18.3.3.1

Except for amounts required to be paid under Article 16.2 by one Party to the other under this Agreement, and except for amounts due under Sections 18.3.1 and 18.3.2, no Party shall be liable to the other Party, directly or indirectly, for any damages or losses of any kind sustained due to any failure to perform this Agreement, unless such failure to perform was malicious or reckless. The limitation of liability shall not apply to billing adjustments for errors in invoiced amounts due under this Agreement, provided such billing adjustments are made within the claims limitation period under Section 18.3.4 of this Agreement.

18.3.3.2

Except for amounts required to be paid by one Party to the other under this Agreement, and except for amounts due under Sections 18.3.1 and 18.3.2, any liability of a Party to the other Party hereunder shall be limited to direct damages as qualified by the following sentence. No lost profits, damages to compensate for lost goodwill, consequential damages, or punitive damages shall be sought or awarded.

18.3.4 Limitation on Claims

No claim seeking an adjustment in the billing for any service, transaction, or charge under this Agreement may be asserted with respect to a month, if more than one year has elapsed since the first date upon which the invoice was rendered for the billing for that month. A Party shall make no adjustment to billing with respect to a month for any service, transaction, or charge under this Agreement, if more than one year has elapsed since the first date upon which the invoice was rendered for the billing for that month, unless a claim seeking such adjustment had been received by the Party prior thereto, provided, however, that no adjustments to billing or resettlement shall be made for any claims asserted within the first year following the date of the filing of the Settlement Agreement and Offer of Settlement (“Settlement”) in Docket Nos. EL10-45 et al. for any time period prior to the date of filing of the Settlement.

18.4 Effective Date and Termination Provision.

The term of this Agreement commences as provided in Section 12.1. The Agreement shall terminate and cease to be effective upon FERC acceptance of the mutual agreement by the Parties to terminate the Agreement or other FERC order terminating the Agreement. Nothing in this Agreement shall prejudice the right of either Party to seek termination of this Agreement under Section 206 of the Federal Power Act, or successor section or statute thereof.

18.5 Survival Provisions.

Upon termination or expiration of this Agreement for any reason or in accordance with its terms, the following Articles and Sections shall be deemed to have survived such termination or expiration:

Article II - (Abbreviations, Acronyms and Definitions)

Article XVI - (Accounting and Allocation of Costs of Joint Operations)

Article XVII- (Retained Rights of the Parties)

Article XVIII- (Additional Provisions), except Section 18.11 (Execution of Counterparts) and Section 18.12 (Amendment)

18.6 No Third-Party Beneficiaries.

This Agreement is intended solely for the benefit of the Parties and their respective successors and permitted assigns and is not intended to and shall not confer any rights or benefits on, any third party (other than the Parties' successors and permitted assigns).

18.7 Successors and Assigns.

This Agreement shall inure to the benefit of and be binding upon the Parties and their respective successors and assigns permitted herein, but shall not be assigned except (a) with the written consent of the non-assigning Party, which consent may be withheld in such Party's absolute discretion; and (b) in the case of a merger, consolidation, sale, or spin-off of substantially all of a Party's assets. In the case of any merger, consolidation, reorganization, sale, or spin-off by a Party, the Party shall assure that the successor or purchaser adopts this Agreement and, the other Party shall be deemed to have consented to such adoption.

18.8 Force Majeure.

No Party shall be in breach of this Agreement to the extent and during the period such Party's performance is made impracticable by any unanticipated cause or causes beyond such Party's control and without such Party's fault or negligence, which may include, but are not limited to, any act, omission, or circumstance occasioned by or in consequence of any act of God, labor disturbance, act of the public enemy, war, insurrection, riot, fire, storm or flood, explosion, breakage or accident to machinery or equipment, or curtailment, order, regulation or restriction imposed by governmental, military or lawfully established civilian authorities. Upon the occurrence of an event considered by a Party to constitute a *force majeure* event, such Party shall use reasonable efforts to endeavor to continue to perform its obligations as far as reasonably practicable and to remedy the event, provided that this Section shall require no Party to settle any strike or labor dispute.

A Party claiming a *force majeure* event shall notify the other Party in writing immediately and in no event later forty-eight (48) hours after the occurrence of the *force majeure* event. The foregoing notwithstanding, the occurrence of a cause under this Section shall not excuse a Party from making any payment otherwise required under this Agreement.

18.9 Governing Law.

This Agreement shall be interpreted, construed and governed by the applicable federal law and the laws of the state of Delaware without giving effect to its conflict of law principles.

18.10 Notice.

Whether expressly so stated or not, all notices, demands, requests and other communications required or permitted by or provided for in this Agreement (“Notice”) shall be given in writing to a Party at the address set forth below, or at such other address as a Party shall designate for itself in writing in accordance with this Section, and shall be delivered by hand or reputable overnight courier:

PJM Interconnection, L.L.C.
2750 Monroe Blvd.
Audubon, PA 19403
Attention: General Counsel

Midcontinent Independent System Operator, Inc.

For Parcels:
720 City Center Drive
Carmel, Indiana 46032
Attention: General Counsel

For U.S. Mail:
P.O. Box 4202
Carmel, Indiana 46082-4202
Attention: General Counsel

18.11 Execution of Counterparts.

This Agreement may be executed in any number of counterparts, each of which shall be an original but all of which together will constitute one instrument, binding upon the Parties hereto, notwithstanding that both Parties may not have executed the same counterpart.

18.12 Amendment.

Except as may otherwise be provided herein, neither this Agreement nor any of the terms hereof may be amended unless such amendment is in writing and signed by the Parties and such amendment has been accepted by the FERC.

ARTICLE XIX
VOLTAGE CONTROL AND REACTIVE POWER COORDINATION

19.1 Coordination Objectives.

Each Party acknowledges that voltage control and reactive power coordination are essential to promote reliability. Therefore, the Parties establish procedures (“Voltage and Reactive Power Coordination Procedures”) under this Article by which they shall conduct such coordination.

19.1.1 Contents of Voltage and Reactive Power Coordination Procedures.

The Voltage and Reactive Power Coordination Procedures address the following components: (a) procedures to assist the Parties in maintaining a wide area view of interconnection conditions by enhancing the coordination of voltage and reactive levels throughout their RTO footprints; (b) procedures to ensure the maintenance of sufficient reactive reserves to respond to scenarios of high load periods, loss of critical reactive resources, and unusually high transfers; and (c) procedures for sharing of data with other neighboring RCs for their analysis and coordinated operation.

19.1.2

The Parties will review the Voltage and Reactive Power Coordination Procedures from time to time to make revisions and enhancements as appropriate to accommodate additional capabilities or changes to industry reliability requirements.

19.2 Voltage and Reactive Power Coordination Procedures.

The Parties will utilize the following procedures to coordinate the use of voltage control equipment to maintain a reliable bulk power transmission system voltage profile on their respective systems.

19.2.1

Under normal conditions, each Party will coordinate with the Transmission Owners, the TOPs and the BAs as necessary and feasible to supply its own reactive load and losses at all load levels.

19.2.2

Voltage schedule coordination is the responsibility of each Party. Generally, the voltage schedule is determined based on conditions in the proximity of generating stations and EHV stations with voltage regulating capabilities. Each Party works with its respective Transmission Owners, TOPs, and BAs to determine adequate and reliable voltage schedules considering actual and post-contingency conditions.

19.2.3

Each Party will establish voltage limits at critical locations within its own system and exchange this information with the other Party. This information shall include normal high voltage limits, normal low voltage limits, post-contingency emergency high voltage limits and post-contingency emergency low voltage limits, and, shall identify the voltage limit value (if available) at which load shedding will be implemented.

19.2.4

Each Party will maintain awareness of the voltage limits in the other Party's area (where the EMS Model includes sufficient detail to permit this) and awareness of outages and potential contingencies that could result in violation of those voltage limits.

19.2.5

The Parties will utilize the following voltage support level definitions for pre- or post-contingency conditions in the development of RTO-coordinated voltage support requests:

19.2.5.1 Emergency Heavy.

This support is necessary when there is an actual low voltage situation due to high loads, heavy transfers, or a critical contingency.

19.2.5.2 Heavy.

This support is necessary in anticipation of high loads or heavy transfers in order to prevent the occurrence of low voltage situations that could result in transfer curtailments.

19.2.5.3 Normal On-Peak.

Reactive support is needed to supply normal loads during peak conditions. No unusually high loads or transfers are expected.

19.2.5.4 Normal Off-Peak.

Reactive support is needed for normal loadings during non-peak conditions. No minimum loads or transfers are expected.

19.2.5.5 Light.

Reactive support is necessary to avoid high voltage due to anticipated minimum load or transfer conditions.

19.2.5.6 Emergency Light.

Reactive support is needed when there is an actual high voltage situation due to minimum loads, transfers, and/or critical contingency.

19.2.6

Each Party shall maintain a list of actions that are taken for each level of voltage support listed in Section 19.2.5. The following outlines some of the actions a Party can take to respond to anticipated or prevailing system conditions.

19.2.6.1 Emergency Heavy.

- (i) Ensure capacitors are in service;
- (ii) Reduce generation, as possible, to maximize reactive output on all units in area of concern;
- (iii) Supply maximum VAR generation (if practical reduce generation to increase reactive output);
- (iv) Adjust EHV tap changers to maximize reactive support to the EHV systems;
- (v) Reduce transfers.

19.2.6.2 Heavy.

- (i) Check all bulk power capacitors;
- (ii) Request Transmission Owners' dispatchers to verify that all capacitors are in service;
- (iii) Adjust EHV tap changers to increase reactive support to the EHV system;
- (iv) Increase generator VAR output to increase support of EHV voltage;
- (v) Maximum reactive output on all EHV generating units, at current MW loading level and within current operating restrictions.

19.2.6.3 Normal On-Peak.

- (i) Bring on capacitors to maintain reactive reserve on generation units;
- (ii) Adjust TCUL transformer set-points to keep capacitors in service;
- (iii) Hold on-peak voltage schedule at all generating stations;

- (iv) Follow normal on-peak voltage schedules;
- (v) Operate capacitors and EHV transformers to tune system voltage.

19.2.6.4 Normal Off-Peak.

- (i) Switch off capacitors as necessary to keep generators at unity or lagging Power Factor;
- (ii) Hold off-peak voltage schedule at all generating stations.

19.2.6.5 Light.

- (i) Deviate from off-peak voltage schedule at generation stations to reduce system voltage without exceeding normal station limits;
- (ii) Request Transmission Owners to switch out all underlying capacitors;
- (iii) Switch out bulk power capacitors;
- (iv) Operate pumped storage generation in pumping mode;
- (v) Adjust EHV transformers so that the EHV system voltages reach their maximum limits simultaneously;
- (vi) Request Transmission Owners to adjust available subtransmission and distribution transformers so that both the high and low side reach maximum voltage limits simultaneously;
- (vii) With advance warning, impose contractual minimums;
- (viii) Allow generating units to operate with leading power factor.

19.2.6.6 Emergency Light.

- (i) Open select EHV lines as studies and conditions permit.

19.2.7 Periodic Meetings.

As part of seasonal preparations, the Parties will conduct meetings to discuss issues due to the anticipated conditions and determine any actions that may be required in response to voltage concerns. The Parties will provide the voltage schedule information on an annual basis to ensure that the information is current.

19.2.8 Additional Coordination.

In concert with the coordination of Outages addressed in Article VII and the Parties' respective day-ahead security analysis processes, the Parties will coordinate the impact of outages and system conditions on the voltage/reactive profile. Coordination will include the following elements:

19.2.8.1

Each Party will review its forecasted loads, transfers, and all information on available generation and transmission reactive power sources at the beginning of each shift.

19.2.8.2

Within the range of Normal On-Peak and Normal Off-Peak, each Party will operate independently in accordance with the above stated criteria and any individual system guidelines for the supply of the Party's reactive power requirements.

19.2.8.3

If either Party anticipates reactive problems after the review, it may request joint implementation of Heavy or Light reactive support levels under these Voltage and Reactive Power Coordination Procedures, as it deems appropriate to the situation. When a Party calls for a particular level of support to be implemented under these procedures, it or the applicable TOP/BA must identify the time it will start adjusting its system, the support level it is implementing, and the voltage problem area.

19.2.8.4

If a Party experiences an actual low or high voltage condition after initial reactive support measures are taken, then the emergency reactive support level is implemented for the area experiencing the problem. The Party will also notify applicable RCs as soon as feasible. In addition, the Voltage and Reactive Power Coordination Procedures are to be consulted to determine if further action is necessary to correct an undesirable voltage situation.

19.2.9 Voltage Schedule Coordination.

The Parties will coordinate the use of voltage control equipment to maintain a reliable bulk power transmission system voltage profile on the the Parties' systems, and surrounding systems. Providing reactive power and proper voltage support to a large interconnected power system is an iterative process. Reactive support starts at the distribution and sub-transmission levels as load increases, substation capacitors are switched, tap changing transformers, and generating unit MVAR outputs are adjusted in concert to hold overall system voltage levels. In general, the voltage schedules are determined by the local TOP based on the local design characteristics and equipment availability. The following procedures are intended to ensure that bulk systems voltage levels enhance system reliability.

19.2.9.1 Specific Voltage Schedule Coordination Actions.

- (a) Each Party has operational or functional control of reactive sources within its system and will direct adjustments to voltage schedules at appropriate facilities.
- (b) Each Party generally will adjust its voltage schedules to best utilize its resources for operation prior to coordinated actions with the other Party.
- (c) If a Party anticipates voltage or reactive problems, it will inform the other Party (operations planning with respect to future day and

RC with respect to same day) of the situation, describe the conditions, and request voltage/reactive support under these Procedures. As a part of the request, the Party must identify the specific area where voltage/reactive support is requested and provide an estimate of the magnitude and time duration of the request as well as the specific requirements for reactive support. The Parties will determine the appropriate measures to address the condition and develop a plan of action.

- (d) Each Party will contact its affected Transmission Owner/TOP/BA. The purpose of this call is to ensure that the situation is fully understood and that an effective operating plan to address the situation has been developed. If necessary the Parties will convene a conference call with the affected Transmission Owners TOPs, and BAs.
- (e) Each Party will implement or direct voltage schedule changes requested by the other Party, provided that a Party may decline a requested change if the change would result in equipment violations or reduce the effective operation of its facilities. A Party that declines a requested change must inform the requesting Party that the request cannot be granted and state the reason for denial.

19.2.10 Voltage/Reactive Transfer Limits.

19.2.10.1

Each Party has wide area transfer interfaces where a MW surrogate is used to control voltage collapse conditions. In cases where the potential for collapse (or cascading) is identified, prompt voltage support and MW generation adjustments may be needed. Where coordinated effort is required for voltage stability interfaces, generation adjustment requests to avoid voltage collapse or cascading conditions must be clearly communicated and implemented promptly. Using these limits the Parties will implement the following real-time coordination:

- (a) **At 95% of Interface Limit**
 - (i) A Party which observes the reading shall call the other Party. Regardless of which Party sees the 95% level reached, both Parties will immediately re-run their analyses to verify results.
 - (ii) The monitoring Party with the preponderance of the flows will notify other RCs via the RCIS.
 - (iii) The Parties will contact the affected TOP/BAs to discuss reactive outputs and adjustments required.

(iv) The applicable Party takes appropriate actions, which may include re-dispatching generation and directing schedule curtailments.

(b) **Exceeding Interface Limit**

- (i) The Party observing the reading will declare an emergency.
- (ii) That Party will inform other RCs of the emergency.
- (iii) The applicable Party will take immediate action, which may include generation redispatch, ordering immediate schedule curtailments, and, if required, load shedding.

19.2.10.2

Where feasible, and if both Parties' EMS models have sufficient detail, each Party will attempt to duplicate the other Party's wide area transfer interface evaluation in order to provide backup limit calculation in the event that the primary Party is unable to accurately determine the appropriate reliability limits.

19.2.10.3

If a new wide area transfer interface is determined to exist and detailed modeling does not exist for the interface, the Parties will coordinate to determine how their models need to be enhanced and to determine procedures for coordination in furtherance of the enhancement.

ARTICLE XX CHANGE MANAGEMENT PROCESS

- 20.1 Notice.** Prior to making a change to any processes that would affect the implementation of the market-to-market process under this Agreement, including (i) the determination of market-to-market settlements, and (ii) revisions to a Party's chosen methodology and calculations to account for import and export tagged transactions from section 4.1.1 of Attachment 2 of the JOA, the Party desiring the change shall notify the other Party in writing or via email of the proposed change. The notice shall include a complete and detailed description of the proposed change, the reason for the proposed change, and the impacts the proposed change will have on the implementation of the market-to-market process, including market-to-market settlements under this Agreement.
- 20.2 Response to Notice.** Within a reasonable time after receipt of the Notice described in Section 20.1, the receiving Party shall: (a) notify in writing or by email the other Party of its concurrence with the proposed change; (b) request in writing or via email additional documentation from the other Party, including associated test documentation; (c) notify in writing or via email the other Party of its disagreement with the proposed change and request that issue regarding the proposed change be addressed pursuant to the dispute resolution procedures set forth in Article XIV of this Agreement. In the event that the receiving Party requests additional documentation as described in (b), within a reasonable time after receipt of such information, it shall notify the other Party in writing or via email that it concurs with the change or that it requests dispute resolution pursuant to Article XIV of this Agreement.
- 20.3 Implementation of Change.** The Party proposing a change to its market-to-market implementation process shall not implement such change until it receives written or email notification from the other Party that the other Party concurs with the change or until completion of any dispute resolution process initiated pursuant to Article XIV of this Agreement. Neither Party shall unduly delay its obligations under this Article XX so as to impede the other Party from timely implementation of a proposed change.
- 20.4 Summary of Proposed Changes.** On a quarterly basis, the Parties shall post on their respective websites a summary of market-to-market implementation process changes proposed by the Parties in the prior quarter and the status of such changes.

ARTICLE XXI
BIENNIAL REVIEW OF PROCESS CHANGES

- 21.1 Biennial Review.** Commencing two years after the issuance of the Baseline Review Report described in the Settlement Agreement and Offer of Settlement (“Settlement”) filed in Docket Nos. EL10-45-000 et al. and every two years thereafter, the Parties shall conduct a comprehensive review of the changes made to each Party’s processes used to implement this Agreement since the previous biennial review, or in the case of the first biennial review, changes made since the issuance of the Baseline Review Report.
- 21.2 Posting of Biennial Review.** The Parties shall post the results of each biennial review on their respective websites.

IN WITNESS WHEREOF, the Parties have caused this Agreement to be executed by their duly authorized representatives.

IN WITNESS WHEREOF, the Parties have caused this Agreement to be executed by their duly authorized representatives.

PJM INTERCONNECTION, L.L.C.

By: 
Name: Richard A. Wodyka
Title: Senior Vice President – RTO Coordination and Integration

Date: December 31, 2003

MIDWEST INDEPENDENT TRANSMISSION SYSTEM OPERATOR, INC.

By: 
Name: James P. Torgerson
Title: President and Chief Executive Officer

Date: _____

ATTACHMENT 1
[RESERVED FOR FUTURE USE]

ATTACHMENT 2

Congestion Management Process (CMP) MASTER

Executive Summary

This Congestion Management Process¹ document provides significant detail in the areas of Market Flow Calculation. These additional details are the result of discussions between multiple Operating Entities.

As Operating Entities expand and implement their respective markets, one of the primary seams issues that must be resolved is how different congestion management methodologies (market-based and traditional) will interact to ensure that parallel flows and impacts are recognized and controlled in a manner that consistently ensures system reliability. This proposed solution will greatly enhance current Interchange Distribution Calculator (IDC) granularity by utilizing existing real-time applications to monitor and react to Flowgates external to an Operating Entity's footprint.

In brief, the process includes the following concepts:

- *Participating Operating Entities will agree to observe limits on an extensive list of coordinated external Flowgates.*
- *Like all Control Areas (CA), Market-Based Operating Entities will have Firm and non-Firm GTL flows upon those Flowgates.*
- *In real-time, Market-Based Operating Entities will calculate and monitor one-hour ahead projected and actual flows.*
- *The IDC will calculate GTL flows for Operating Entities using the State Estimator data provided by the entities.*
- *Market-Based Operating Entities will calculate the actual and the one-hour ahead projected Firm and non-Firm limits for both internal and external Coordinated Flowgates.*
- *Market-Based Operating Entities will constrain their operations to limit Firm GTL flows on the Coordinated Flowgates to no more than the calculated Firm Flow Limit established in the analysis.*
- *Market-Based Operating Entities will provide to the IDC detailed representation of their marginal units, so that the IDC can continue to effectively compute the effects of all tagged transactions regardless of the size of the market area. These tagged transactions will include transactions into the market, transactions out of the market, transactions through the market, and tagged grandfathered transactions within the market.*

¹ Capitalized terms that are not defined in this Attachment 2 shall have the meaning set forth in the body, appendices, and attachments of the *Joint Operating Agreement Between Midcontinent Independent System Operator, Inc. and PJM Interconnection, L.L.C.*

- *When there is a Transmission Loading Relief (TLR) 3a request or higher called on a Coordinated Flowgate, and the Market-Based Operating Entity's actual/one-hour ahead projected IDC GTL flows exceed the Firm Flow Limits, Market-Based Operating Entities will respond to their relief obligations by redispatching their systems in a manner that is consistent with how non-market entities respond to their share of IDC GTL relief obligations per the IDC congestion management report.*
- *The above processes refer to the "Congestion Management" portion of the paper, which will be implemented by Market-Based Operating Entities.*
- *Additional entities may choose to enter into similar Reciprocal Coordination Agreements that describe how Available Transfer Capability (ATC)/Available Flowgate Capability (AFC), Firm Flows, and outage maintenance will be coordinated on a forward basis.*
- *The complete process will allow participating Operating Entities to address the reliability aspects of congestion management seams issues between all parties whether the seams are between market to non-market operations or market-to-market operations.*

Change Summary

Generate baseline Congestion Management Process (CMP) document based on CMP documents executed by:

- Manitoba Hydro and Midcontinent Independent System Operator, Inc. (MISO)
- Mid-Continent Area Power Pool (MAPP) and MISO
- MISO and PJM Interconnection, L.L.C. (PJM)
- MISO, PJM and Tennessee Valley Authority (TVA)
- MISO and Southwest Power Pool, Inc. (SPP)

The document also includes subsequent changes agreed upon by a majority of the Congestion Management Process Council (CMPC). For items which are specific to a limited number of agreements, the CMP members have used an approach of documenting these unique items in separate appendices rather than in the base document. The CMPC members reserve all rights with respect to the different options identified in the appendices attached hereto without any obligation to adopt or support such options. The CMPC members reserve the right to oppose any position taken by another CMPC member in a FERC filing or otherwise with respect to the choice of options listed in the appendices. Nothing contained herein shall be construed to indicate the support or agreement by the CMPC members to an option presented in the appendices.

Revision 1.1 (November 30, 2007)

Per FERC Order ER07-1417-000, in the “Forward Coordination Processes” section 6.6 added the word “outage” between “unit” and “scheduling” in the following sentence, “Market-Based Operating Entities will use the Flowgate limit to restrict unit outage scheduling for a Coordinated Flowgate when maintenance outage coordination indicates possible congestion and there is recent TLR activity on a Flowgate.”

Revision 1.2 (May 2, 2008)

The Market Flow Threshold is changing from 3% to 5%. The NERC Standards Committee approved changing the Market Flow Threshold for the field test at its April 10, 2008 meeting.

Revision 1.3 (July 16, 2008)

Per FERC Order issued in Docket Nos. ER08-884-000 and ER08-913-000, *Appendix H (Market Flow Threshold Field Test Terms And Conditions)* was added.

Revision 1.4 (October 31, 2008)

The percentages were changed in Sections 4.4 (*Firm Market Flow Calculation Rules*) and 5.5 (*Market-Based Operating Entity Real-time Actions*) to be consistent with changes made under Revision 1.2. *Appendix H – Market Flow Threshold Field Test Terms And Conditions* was updated to reflect the NERC approved Market Flow Threshold Field Test extension to October 31, 2009.

Revision 1.5 (December 18, 2008)

Updated Section 5.2 (*Quantify and Provide Data for Market Flow*) and *Appendix B – Determination of Marginal Zone Participation Factors* to support changes to the manner in which MISO uses marginal zones and submits marginal zone information to the IDC.

Revision 1.6 (February 19, 2009)

Appendix H – Market Flow Threshold Field Test Terms And Conditions was updated to reflect that MISO no longer has a contractual obligation to observe a 0% threshold for MISO Market Flows on Flowgates where both MAPP and MISO are reciprocal.

Revision 1.7 (November 1, 2009)

Applied updates based on the results of the Market Flow Threshold Field Test including clarifications that allocations are calculated down to zero percent. Changes have been applied to the *Executive Summary*, *Section 4.1 Market Flow Determination*, *Section 4.4 Firm Market Flow Calculation Rules*, *Section 5.5 Market-Based Operating Entity Real-time Actions*, *Section 6.6 Forward Coordination Processes*, *Section 6.6.3 Limiting Firm Transmission Service*, *Section 6.7 Sharing or Transferring Unused Allocations*, and *Appendix H – Application of Market Flow Threshold Field Test Conditions*.

Revision 1.8 (May 31, 2010)

Applied updates to further standardize the “Allocation Adjustment for New Transmission Facilities and/or Designated Network Resources” process. Changes have been made to *Appendix F – FERC Dispute Resolution* and *Appendix G – Allocation Adjustments for New Transmission Facilities and/or Designated Network Resources*.

Revision 1.9 (January 4, 2011)

Modified to incorporate the revisions to the JOA, including revisions to Attachments 2 and 3, submitted as part of the Settlement Agreement and Offer of Settlement in Docket Nos. EL10-45-000, EL10-46-000, and EL10-60-000.

Revision 1.10 (July 25, 2016)

Generated updated baseline CMP document executed by the following entities:

- Manitoba Hydro and MISO
- Minnkota Power Cooperative, Inc. and MISO
- MISO and PJM
- PJM and TVA
 - Louisville Gas and Electric Company/Kentucky Utilities Company (LG&E/KU) and Associated Electric Cooperative, Inc. (AECI) executed separate agreements with TVA stipulating the CMP provisions executed by PJM and TVA apply to AECI and LG&E/KU as Reciprocal Entities.
- MISO and SPP
- MISO Attachment LL

Section	Revision Description
3.2	Clarified language on inclusion of Coordinated Flowgates in AFC process. Removed consideration of reverse impacts when performing Flowgate studies.
3.2.1	Revised language to better describe how the four Flowgate studies used to identify Coordinated Flowgates are performed.
3.2.6	Added a new section requiring coordination between Parties before making a Flowgate permanent that includes a Tie Line monitored element.
4.1	Revised language to require a Market-Based Operating Entity to consistently account for export and import tagged transactions in the identified calculations using one of the three methodologies set forth in the new Section 4.1.1. Revisions have previously been accepted by FERC in the CMP documents executed between MISO and PJM, MISO and SPP, and PJM and TVA.
4.1.1	
6.10	Added a new section listing the requirements that must be satisfied for a Combining Party to incorporate a Non-Reciprocal Entity's load and the associated generation serving that load into the Reciprocal's Entity's Allocation calculations.
Appendix A	Added the following defined terms: Agreement, Combining Party, Non-Reciprocal Entity, Party, Third-Party, and Tie Line.
Appendix B	Revised language addressing how a Market-Based Operating Entity using the Marginal Zone methodology will determine marginal zone participation factors. Revisions have previously been accepted by FERC in the CMP documents executed between MISO and PJM, MISO and SPP, and PJM and TVA.
Appendix C	Clarified in Figure C-1 and Table C-1 the steps on inclusion of Coordinated Flowgates in the AFC process.

Revision 1.11 (June 1, 2017)

Per NERC Operating Reliability Subcommittee applied updates necessary for MISO to incorporate External Asynchronous Resources into MISO Market Flows.

Section	Revision Description
3.2	Updated the number of Coordination Flowgate studies from four to five.
3.2.1	Clarified Study 4 applies internal CA/CA permutations and added a new Study 5 specific to External Asynchronous Resources.
3.2.2	Updated the number of Coordination Flowgate studies from four to five.
3.2.5	
4.1	Added how the External Asynchronous Resources will be considered in Market Flow and the exclusion of the related tags from IDC.
6.2	Updated the number of Coordination Flowgate studies from four to five.
6.8	Specified the priority of the Market Flow will correspond to the priority of the tag.
Appendix A	Added a new definition specific to MISO, External Asynchronous Resources. Updated the number of Coordination Flowgate studies from four to five.
Appendix C	Updated the number of Coordination Flowgate studies from four to five in Table C-1.

Revisions 1.12 (June 2, 2022)

Updated to reflect the PFV changes as per NAESB Standard

Table of Contents

SECTION 1 – INTRODUCTION

- 1.1 Problem Definition
 - 1.1.1 The Nature of Energy Flows
 - 1.1.2 Granularity in the IDC
 - 1.1.3 Reduced Data and Granularity Coarseness
 - 1.1.4 Accounting for Loop Flows
 - 1.1.5 Conclusion
- 1.2 Process Scope and Limitations
 - 1.2.1 Vision Statement
 - 1.2.2 Process Scope
- 1.3 Goals and Metrics
- 1.4 Assumptions

SECTION 2 – PROCESS OVERVIEW

- 2.1 Summary of Process

SECTION 3 – IMPACTED FLOWGATE DETERMINATION

- 3.1 Flowgates
- 3.2 Coordinated Flowgates
 - 3.2.1 Flowgate Studies
 - 3.2.2 Disputed Flowgates
 - 3.2.3 Third Party Request Flowgate Additions
 - 3.2.4 Frequency of Coordinated Flowgate Determination
 - 3.2.5 Dynamic Creation of Coordinated Flowgates
 - 3.2.6 Coordination of Tie Line Flowgate Additions

SECTION 4 – MARKET-BASED OPERATING ENTITY FLOW CALCULATIONS: MARKET FLOW, FIRM MARKET FLOW, AND NON-FIRM MARKET FLOW

- 4.1 Market Flow Determination
- 4.2 Firm Flow Determination
- 4.3 Determining the Firm Flow Limit
- 4.4 Firm Flow Limit Calculation Rules

SECTION 5 – MARKET-BASED OPERATING ENTITY CONGESTION MANAGEMENT

- 5.1 Calculating Market Flows
- 5.2 Quantify and Provide Data for Firm Flow Limits
- 5.3 Day-Ahead Operations Process
- 5.4 Real-time Operations Process – Operating Entity Capabilities
- 5.5 Market-Based Operating Entity Real-time Actions

SECTION 6 – RECIPROCAL OPERATIONS

- 6.1 Reciprocal Coordinated Flowgates
- 6.2 The Relationship Between Coordinated Flowgates and Reciprocal Coordinated Flowgates
- 6.3 Coordination Process for Reciprocal Flowgates
- 6.4 Calculating Historic Firm Flows
- 6.5 Recalculation of Initial Historic Firm Flow Values and Ratios
- 6.6 Forward Coordination Processes
 - 6.6.1 Determining Firm Transmission Service Impacts
 - 6.6.2 Rules for Considering Firm Transmission Service
 - 6.6.3 Limiting Firm Transmission Service
- 6.7 Sharing or Transferring Unused Allocations
 - 6.7.1 General Principles
 - 6.7.2 Provisions for Sharing or Transferring of Unused Allocations
- 6.8 The Application of Firm Flow Limits in the IDC
- 6.9 Real-time Operations Process for Market-Based Operating Entities
 - 6.9.1 Market-Based Operating Entity Capabilities
 - 6.9.2 Market-Based Operating Entity Real-time Actions
- 6.10 Requirements to Combine Allocations with Non-Reciprocal Entity

SECTION 7 – APPENDICES

- Appendix A – Glossary
- Appendix B – Determination of Marginal Zone Participation Factors
- Appendix C – Flowgate Determination Process

Appendix D – Training

Appendix E – Reserved

Appendix F – FERC Dispute Resolution

Appendix G – Allocation Adjustment for New Transmission Facilities and/or Designated Network Resources

Appendix H – Application of Market Flow Threshold Field Test Conditions

Section 1 – Introduction

It is the intention of the Reciprocal Entities to utilize the processes within this document. It is further the intention to develop this process in a way that will allow other regional entities with similar concerns to utilize the concepts within this process to aid in the resolution of their own seams issues.

1.1 Problem Definition

1.1.1 The Nature of Energy Flows

Energy flows are distinctly different from the manner in which the energy commodity is purchased, sold, and ultimately scheduled. In the current practice of “contract path” scheduling, schedules identify a source point for generation of energy, a series of wheeling agreements being utilized to transport that energy, and a specific sink point where that energy is being consumed by a load. However, due to the electrical characteristics of the Eastern Interconnection, energy flows are more dispersed than what is described within that schedule. This disconnect becomes of concern when there is a need to take actions on contract-path schedules to effect changes on the physical system (for example, the curtailment of schedules to relieve transmission constraints).

In the Eastern Interconnection, much of this concern has been addressed through the use of the North American Electric Reliability Corporation (NERC) and/or North American Energy Standards Board (NAESB) TLR process. Through this process, Reliability Coordinators utilize the IDC to determine appropriate actions to provide that relief. The IDC bases its calculations on the use of transaction tags: electronic documents that specify a source and a sink, which can be used to estimate real power flows through the use of a network model. In order to change flows, the IDC is given a particular constraint and a desired change in flows. The IDC returns back all source to sink transactions that contribute to that constraint and specifies schedule changes to be made that will effect that change in flows.

In other parts of the Eastern Interconnection, however, the use of centralized economic dispatch results in a solution that does not focus on changing entire transactions (effectively redispatching through the use of imbalance energy), but rather redispatch itself. In this procedure, the party attempting to provide relief does not need to know that a balanced source to sink transaction should be adjusted; rather, they are aware of a net generation to load balance and the impacts of different generators on various constraints. Bid-based security constrained central dispatch based on Locational Marginal Pricing is a regional implementation of this practice.

Currently, these two practices are somewhat incompatible. Due to the electrical characteristics of the Interconnection and geographic scope of the regions, this incompatibility has been of limited concern. However, regional market expansion has begun to draw attention to this operational disjoint, as the expansion itself exacerbates the negative effects of the incompatibility.

1.1.2 Granularity in the IDC

The IDC uses an approximation of the Interconnection to identify impacts on a particular transmission constraint that are caused by flows between Control Areas. This approximation allows for a Reliability Coordinator to identify tagged transactions with specific sources and sinks that are contributing to the constraint. While tagged transactions may specify sources and sinks in a very specific manner, the IDC in general cannot respect this detail, and instead

consolidates the impacts of several generators and loads into a homogenous representation of the impacts of a single Control Area. This is referred to as the *granularity* of the IDC. Current granularity is typically defined to the Control Area level; finer granularity is present in certain special situations as deemed necessary by NERC.

1.1.3 Reduced Data and Granularity Coarseness

As centrally dispatched energy markets expand their footprint, two related changes occur with regard to the above process. In some cases, data previously sent to the IDC is no longer sent due to the fact that it is no longer tagged. In others, transactions remain tagged, but the increased market footprint results in an increase in granularity coarseness within the IDC; that is, the apparent Control Area boundary becomes the same as the market boundary so that what had been historically 30 or more Control Areas now appears as one.

In the first change, transactions contained entirely within the market footprint are considered to be utilizing network service (even when the market spans multiple Control Areas). As such, there is no requirement for them to be tagged (or such requirement is waived by NERC), and therefore, no requirement that they be sent to the IDC. This is of concern from a reliability perspective, as the IDC will no longer have a large pool of transactions from which to provide relief, although the energy flows may remain consistent with those prior to the market expansion. In other words, flows subject to TLR curtailment prior to the market expansion are no longer available for that process.

In the second change, the expansion of the footprint itself results in a dilution of the approximation utilized by the IDC. When a market region is relatively small (or isolated), the Control Area to Control Area approximation of that region's impact on transmission constraints is acceptable; actions within the market footprint generally have a similar and consistent impact on all transmission facilities outside the footprint. However, when the market footprint expands significantly, and is co-mingled with non-market Control Areas, the ability to utilize the historic approximation of electrically representative flows fails to effectively predict energy flow. Impacts on external facilities can vary significantly depending on the dispatch of the resources within the market footprint. With regard to the IDC, this information is effectively lost within the expanded footprint, and results in an increase in the level of granularity coarseness, or a "loss of granularity."

1.1.4 Accounting for Loop Flows

The processes for accounting for loop flows caused by uses of the transmission system between Control Areas are different under a market environment. Absent a market, loop flows from Transmission Service reservations between Control Areas are identified and accounted for by importing transmission reservations from surrounding systems. Under a market environment, the market will not have explicit transmission reservations for evolving market dispatch conditions between market Control Areas. Thus, a mechanism for accounting for anticipated Market Flows on non-market systems is necessary.

1.1.5 Conclusion

The net effect of these changes is that reliability must be managed through different processes than those used before the market region's expansion. While relief can still be requested using the current process, both the ability to predict the effectiveness of a curtailment to provide that relief and the general pool of transactions available for curtailment are reduced. This CMP offers a strategy for eliminating this concern through a process that provides more information (finer granularity) to the IDC for the market area. This new congestion management process will ensure that reliability is not adversely affected as markets expand by providing information and relief opportunities previously unavailable to the IDC.

1.2 Process Scope and Limitations

1.2.1 Vision Statement

As Operating Entities become Market-Based Operating Entities, and expand their various markets, one of the primary seams issues that must be resolved is how different congestion management methodologies (market-based and traditional TLR) will interact to ensure parallel flows and impacts are recognized and controlled in a manner that consistently ensures system reliability and equitability. Reliability Coordinators can mandate emergency procedures to maintain safe operating limits, however, without coordination agreements that maintain flow limits in advance, the market would become volatile and the burden for relieving excess flow would ignore the economics of the entities which would be required to redispatch. For these entities, this process will offer a manner in which Market-Based Operating Entities can coordinate parallel flows with Operating Entities that have not yet or do not contemplate implementing markets. This process will provide more proactive management of transmission resources, more accurate information to Reliability Coordinators, and more candidates for providing relief when reliability is threatened due to transmission overload conditions.

1.2.2 Process Scope

This process has been written specifically with the goal of coordinating seams between Reciprocal Entities and their respective neighbors.

1.3 Goals and Metrics

This document focuses on a solution to meet the following goals and requirements:

1. Develop a congestion management process whereby transmission overloads can be prevented through a shared and effective reduction in Flowgate or constraint usage by Reciprocal Entities and adjoining Reliability Coordinators.
2. Agree on a predefined set of Flowgates or constraints to be considered by all Reciprocal Entities, and a process to maintain this set as necessary.
3. Determine the best way to calculate flow due to market impacts on a defined set of Flowgates.
4. Develop Reciprocal Coordination Agreements that establish how each Operating Entity will consider its own Flowgate or constraint usage as well as the usage of other Operating Entities when it determines the amount of Flowgate or constraint capacity remaining. This process will include both operating horizon determination as well as forward looking capacity allocation.
5. Develop a procedure for managing congestion when Flowgates are impacted by both tagged and untagged energy flow.
6. Develop a procedure for determining the priorities of untagged energy flows (created through parallel flows from the market).
7. Agree on steps to be taken by Operating Entities to unload a constraint on a shared basis.
8. Determine whether procedure(s) for managing congestion will differ based on where the Flowgate is located (*i.e.*, inside Reciprocal Entity A, inside Reciprocal Entity B, or outside both Reciprocal Entity A and Reciprocal Entity B).
9. Confirm that the solution will be equitable, transparent, auditable, and independent for all parties.
10. Develop methodology to preserve and accommodate grandfathered transmission rights, contract rights, and other joint-use agreements.
11. Develop methodology to address changes in Total Transfer Capability (TTC), such as future system topology changes, new Designated Network Resources (DNRs), facility updates/derates, prior outage limitations, etc., with respect to Allocation implications.
12. Develop a methodology for releasing Allocations if other parties do not join the process or if there is ATC going unused.

1.4 Assumptions

The processes set forth in this document were based on the following assumptions:

- Point-to-point schedules sinking in, sourcing from, or passing through an Operating Entity will be tagged.
- The IDC or a similar repository of schedules is needed at the Interconnection's current state and for the foreseeable future.
- The Operating Entity's Energy Management System (EMS) has the capability to monitor and respond to real-time and projected flows created by its real-time dispatch.
- The Reliability Coordinator of the area in which a Flowgate exists will be responsible for monitoring the Flowgate, determining any amount of relief needed, and entering the required relief in the IDC.
- The IDC has been modified to accept the submitted values of the real-time generation, load, and other real-time data.
- The IDC calculates the impacts of the untagged dispatch (GTL) on the Flowgates for all Operating Entities using Parallel Flow Visualization (PFV).
- The IDC will determine the Firm and non-Firm GTL flow for each Market-Based Operating Entity using the Firm and non-Firm limits calculated in this agreement.
- The IDC can calculate the total amount of MW relief required by the Operating Entity (schedule curtailments required plus the relief provided by redispatch).

2.1 Summary of Process

In order to coordinate congestion management, a bridge must be established that provides for comparable actions between Operating Entities. Without such a bridge, it is difficult, if not impossible, to ensure reliability and system coordination in an efficient and equitable manner. To effect this coordination of congestion management activities, we propose a methodology for determining both firm and non-firm flows resulting from Market-Based Operating Entity dispatch on external parties' Flowgates.

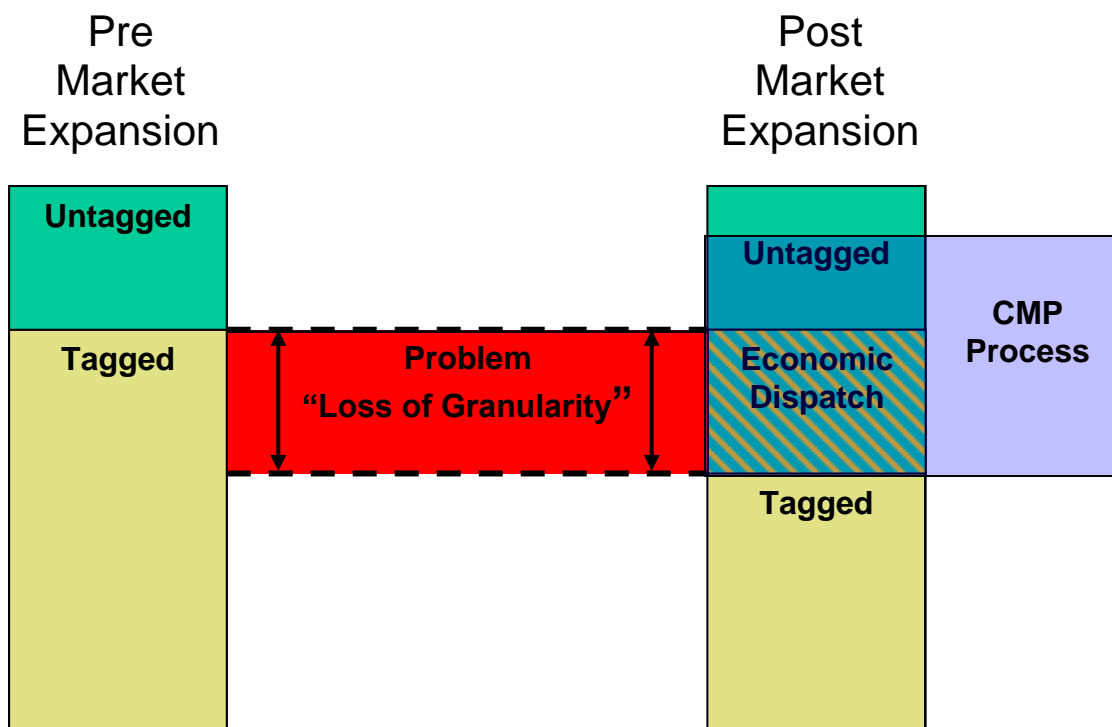

GTL flows are the calculated energy flows on a specified Flowgate as a result of dispatch of generating resources serving load within an Operating Entity's Control Area. (Note: For the purposes of the Reciprocal Coordination process discussed later, Firm Transmission Service (7F) will be combined with the untagged firm component of Market Flows in the calculation of Historic Firm Flow. The Historic Firm Flow is described later in this document).

The IDC currently calculates GTL flows for each CA in the Eastern Interconnection and used to determine each Operating Entities curtailment under a TLR. The methodology defined in this document determines how to quantify these GTL flows as Firm and non-Firm for each Market-Based Operating Entity. Market Flow is a calculation similar to GTL, but is no longer used to determine relief obligations in the TLR protocol. However, Market Flow may still be used for congestion management between Market-Based Operating Entities, and thus we continue to define it in this agreement for reference.

GTL flows can be divided into Firm and Non-Firm. Firm GTL flows are considered as firm use of the transmission system for congestion management purposes and will be curtailed on a proportional basis with other firm uses during periods of firm curtailments and are equivalent to Firm Transmission Service. Non-Firm GTL flows are considered as non-firm use of the transmission system for congestion management purposes and will be curtailed on a proportional basis with other non-firm uses during periods of non-firm curtailments and are equivalent to non-firm Transmission Service. As such, Reliability Coordinators can request Market-Based Operating Entities to provide relief under TLR based on these transmission priorities.

By applying the above philosophy to the problem of coordinating congestion management, we can determine not only the impacts of a Market-Based Operating Entity's dispatch on a particular Flowgate; we can also determine the appropriate firmness of those flows. This results in the ability to coordinate both proactive and reactive congestion management between operating entities in a way that respects the current TLR process, while still allowing for the flexibility of internal congestion management based on market prices.

There are two areas that must be defined in order for this process to work effectively:

- **Coordinated Flowgate Definition.** In order to ensure that impacts of dispatch are properly recognized, a list of Flowgates must be developed around which congestion management may be effected and coordination can be established.
- **Congestion Management.** By coordinating congestion management efforts and enhancing the TLR process to recognize both untagged energy flows and data of finer granularity, we can ensure that when TLR is called, the appropriate non-firm flows are reduced before Firm Flows. This coordination will result in a reduction of TLR 5 events, as more relief will be available in TLR 3 to mitigate a constraint. This is accomplished through the calculation of flows due to economic dispatch, as well as by providing marginal unit information to aid in interchange transaction management.

The next sections of this document discuss each of these areas in detail.

Section 3 – Impacted Flowgate Determination

3.1 Flowgates

Flowgates are facilities or groups of facilities that may act as significant constraint points on the system. As such, they are typically used to analyze or monitor the effects of power flows on the bulk transmission grid. Operating Entities utilize Flowgates in various capacities to coordinate operations and manage reliability. For the purpose of this process, there are three kinds of Flowgates: AFC Flowgates, which are defined in Appendix A, Coordinated Flowgates (CFs), which are defined below, and Reciprocal Coordinated Flowgates (RCFs), which are defined in “Reciprocal Operations” Section 6. A diagram illustrating how these three categories of Flowgates are determined is included as Appendix C.

3.2 Coordinated Flowgates

An Operating Entity will conduct sensitivity studies to determine which Flowgates are significantly impacted by the flows of the Operating Entity’s Control Zones (historic Control Areas that existed in the IDC). An Operating Entity identifies these Flowgates by performing the following five studies to determine which Flowgates the Operating Entity will monitor and help control. As set forth in Appendix C, a Flowgate passing any one of these studies will be considered a Coordinated Flowgate and AFCs shall be computed for these Flowgates, unless mutually agreed otherwise by the Operating Entities and any Reciprocal Entities for the Flowgate. An Operating Entity shall add a Coordinated Flowgate to its AFC process as soon as practical in accordance with the Operating Entity’s processes. Nothing in this section precludes an Operating Entity or Reciprocal Entity from calculating AFCs for any Flowgates.

An Operating Entity may also specify additional Flowgates that have not passed any of the five studies to be Coordinated Flowgates where the Operating Entity expects to utilize the TLR process to manage congestion. For a list of Coordinated Flowgates between Reciprocal Entities, see each Reciprocal Entity’s Open Access Same-Time Information System (OASIS) website.

Coordinated Flowgates are identified to determine which Flowgates an entity impacts significantly. This set of Flowgates may then be used in the congestion management processes and/or Reciprocal Operations defined in this document.

When performing the five Flowgate studies, a 5% threshold will be used based on the positive impact. Use of a 5% threshold in the studies may not capture all Flowgates that experience a significant impact due to operations. The Operating Entities have agreed to adopt a lower threshold at the time NERC and/or NAESB implements the use of a lower threshold in the TLR process.

3.2.1 Flowgate Studies

Study 1) – IDC GLDF

(using the IDC tool)

Upon request by an Operating Entity, a study will be performed using the IDC reflecting the topology of the system from the System Data Exchange (SDX) or any industry-accepted system with similar capabilities. The IDC can provide a list of Flowgates for any user-specified Control Area whose Generator to Load Distribution Factor (GLDF) NNL impact is 5% or greater. Using the historic Control Area representation in the IDC, if any one generator has a GLDF that is 5% or greater as determined by the IDC, this Flowgate will be considered a Coordinated Flowgate.

Study 2) – IDC PSS/E Base Case GLDF

(no transmission outages – offline study)

Upon request by an Operating Entity, the Operating Entity to which the request is made will perform a generator analysis to determine which Flowgates impacted by those CAs will be included in the list of Coordinated Flowgates. To provide better confidence that the

Operating Entity has effectively captured the subset of Flowgates upon which its generators have a significant impact, the Operating Entity will perform an offline study utilizing Managing and Utilizing System Transmission (MUST) or other industry-accepted software with similar capabilities. The Operating Entity will perform off-line studies using the IDC PSS/E base case. If any generator has a GLDF that is 5% or greater as determined by this Study 2, this Flowgate will be considered a Coordinated Flowgate. Study 1 above and this Study 2 are separate studies. There is no requirement that a Flowgate must pass both studies in order to be coordinated.

Study 3) – IDC PSS/E Base Case GLDF

(transmission outage - offline study)

Upon request by an Operating Entity, the Operating Entity to which the request is made will perform a Flowgate analysis to determine which Flowgates impacted by those CAs will be included in the list of Coordinated Flowgates. The Flowgates determined using Study 2 above or Study 4 below that have a 3% to 5% distribution factor will be analyzed in this Study 3 against prior outage conditions. The Operating Entity will perform off-line studies using the IDC PSS/E base case utilizing MUST or other industry- accepted software with similar capabilities. The Operating Entity, in consultation with affected operating authorities, will perform a prior outage analysis, including both internal and external outages, by applying one of the following:

1. transmission facilities operated at 100kV and above, in the CA where the Flowgate's monitored facility(ies) is located and in CAs that are first tier to the CA where the Flowgate's monitored facility(ies) is located; or
2. transmission facilities operated at 100kV and above within 10 buses from the monitored facility(ies).

If any Flowgates with a 3% to 5% distribution factor from Study 2 or Study 4 are impacted by 5% or more from a prior outage condition (Line Outage Distribution Factor (LODF)) from this Study 3, the Flowgate will be added to the list of Coordinated Flowgates.

Study 4) – IDC Base Case Transfer Distribution Factors

(no transmission outages – offline study)

Upon request by an Operating Entity, the Operating Entity to which the request is made will perform a Flowgate analysis to determine which Flowgates impacted by those CAs will be included in the list of Coordinated Flowgates. The Operating Entity performing this analysis will analyze internal transactions between each historic CA/CA permutation. OTDF Flowgates will be analyzed with the contingent element out of service. The Operating Entity will perform off-line studies using the IDC PSS/E base case utilizing MUST, or other industry-accepted software with similar capabilities to determine the

Transfer Distribution Factors (TDFs). Flowgates that are impacted by 5% or greater by Study 4 will be considered a Coordinated Flowgate.

Study 5) – External Asynchronous Resource (EAR)

Upon request by an Operating Entity, MISO shall rerun Study 4 (no outage scenario) to determine the flowgates impacted by its EAR. Additionally, a second study will be performed using the IDC reflecting the topology of the system from the System Data Exchange (SDX) or any industry-accepted system with similar capabilities. Both studies performed under Study 5 shall utilize the following assumptions: 1) the source to sink TDF calculation of the EAR shall be evaluated in the same way IDC would evaluate the impacts of the associated tag (e.g., source and sink of the EAR); and 2) any flowgate that is determined to be impacted by the EAR by 5% or greater will be considered a Coordinated Flowgate.

3.2.2 Disputed Flowgates

If a Reciprocal Entity believes that another Reciprocal Entity implementing the congestion management portion of this process has a significant impact on one of their Flowgates, but that Flowgate was not included in the Coordinated Flowgate list, the involved Reciprocal Entities will use the following process:

- If an operating emergency exists involving the candidate Flowgate, the Reciprocal Entities shall treat the facilities as a temporary Coordinated Flowgate prior to the study procedure below. If no operating emergency or imminent danger exists, the study procedure below shall be pursued prior to the candidate Flowgate being designated as a Coordinated Flowgate.
- The Reciprocal Entity conducts studies to determine the conditions under which the other Reciprocal Entity would have a significant impact on the Flowgate in question. The Reciprocal Entity conducting the study then submits these studies to the other Reciprocal Entity implementing this process. The Reciprocal Entity's studies should include each of the five studies described above; in addition to any other studies they believe illustrate the validity of their request. The other Reciprocal Entity will review the studies and determine if they appear to support the request of the Reciprocal Entity conducting the study. If they do, the Flowgate will be added to the list of Coordinated Flowgates.
- If, following evaluation of the supplied studies, any Reciprocal Entity still disputes another Reciprocal Entity's request, the Reciprocal Entity will submit a formal request to the NERC Operations Reliability Subcommittee (ORS) asking for further review of the situation. The ORS will review the studies of both the requesting Reciprocal Entity and the other Reciprocal Entity, and direct the participating Reciprocal Entities to take appropriate action.

3.2.3 Third Party Request Flowgate Additions

Each Party shall provide opportunities for Third Parties or other entities to propose additional Coordinated Flowgates and procedures for review of relevant non-confidential data in order to assess the merit of the proposal. The current procedure for the review and maintenance of Coordinated Flowgates is set forth in Appendix C.

3.2.4 Frequency of Coordinated Flowgate Determination

The determination of Coordinated Flowgates will be performed at the initial implementation of the CMP and then on a periodic basis, as described in Appendix C.

3.2.5 Dynamic Creation of Coordinated Flowgates

For temporary Flowgates developed “on the fly,” the IDC will calculate GTL relief obligation based on GPS and TSNT method and once market entities submit the Firm Flow Limits the GTL relief obligation will be based on submitted Firm Flow Limits on the new Flowgate. Interchange transactions into, out of, or across the Market-Based Operating Entity will continue to be E-tagged and available for curtailment in TLR 3, 4, or 5. Market-Based Operating Entities will study the Flowgate in a timely manner and begin reporting Flowgate data within no more than two business days (where the Flowgate has already been designated as an AFC Flowgate). This will ensure that the Market-Based Operating Entity has the time necessary to properly study the Flowgate using the five studies detailed earlier in this document and determine the Flowgate’s relationship with the Market-Based Operating Entity’s dispatch. For internal Flowgates, the Market-Based Operating Entity will redispatch during a TLR 3 to manage the constraint as necessary until it begins reporting the Firm and Non-Firm Limits; during a TLR 5, the IDC will request GTL relief obligation in the same manner as today. Alternatively, for internal and external Flowgates, an Operating Entity may utilize an appropriate substitute Coordinated Flowgate that has similar Market Flows and tag impacts as the temporary Flowgate. In this case, an Operating Entity would have to realize relief through redispatch and TLR 3. An example of an appropriate substitute would be a Flowgate with a monitored element directly in series with a temporary Flowgate’s monitored element and with the same contingent element. If the Flowgate meets the necessary criteria, the Market-Based Operating Entity will begin to provide the necessary values to the IDC in the same manner as Market Flow values are provided to the IDC for all other Coordinated Flowgates. The necessary criteria for adding a Flowgate are defined in Appendix C. If in the event of a system emergency (TLR 3b or higher) and the situation requires a response faster than the process may provide, the Market-Based Operating Entities will coordinate respective actions to provide immediate relief until final review.

3.2.6 Coordination of Tie Line Flowgate Additions

The Parties shall follow the coordination process outlined in this section for Flowgates that include a Tie Line between the Parties as a monitored element. The provisions in this section shall not apply to any temporary Flowgates.

Procedures:

1. Unless otherwise agreed to by the Parties, the managing entity for a Tie Line Flowgate is the Party that has functional control over the most limiting equipment for the Flowgate.
2. The managing entity for a Tie Line Flowgate shall calculate AFCs, post AFCs, process requests for transmission service, manage real-time congestion, and calculate Allocations for the Tie Line Flowgate.
3. Before the creation of a new Tie Line Flowgate in the IDC, the managing entity for the Tie Line Flowgate must notify the other Party no less than sixty (60) days in advance of the addition of the Tie Line Flowgate in the IDC. The new Flowgate will initially be created as a temporary Flowgate in the IDC by the managing entity. If all other requirements outlined in this Section 3.2.6 are completed during the sixty (60) days following notice, the Flowgate can be made permanent before the sixty (60) day deadline by mutual agreement of the Parties.
4. A Party that identifies a new Tie Line Flowgate through a study shall provide the study assumptions, methodology, and all other relevant data to the other Party in a timely manner.
5. AFC Calculation and Posting AFCs:
 - a. The managing entity will calculate and post AFCs for Tie Line Flowgates in accordance with the managing entity's processes (i.e., the managing entity will treat the Flowgates as internal Flowgates).
 - b. The managing entity will post AFC files for Tie Line Flowgates for use by other transmission providers.
 - c. The managing entity will apply AFC factors for Tie Line Flowgates (e.g., TRM, CBM, "a" and "b" multipliers, etc.) using the managing entity's own processes.
6. Upon the completion of items 1 through 5, the managing entity may create a permanent Tie Line Flowgate.
7. The Party that is not the managing entity will replace the temporary Tie Line Flowgate with the permanent Tie Line Flowgate in its applicable operating system(s).

Section 4 – Market-Based Operating Entity Flow Calculations: Market Flow, Firm Market Flow, and Non-Firm Market Flow

Market Flows on a Coordinated Flowgate can be quantified and considered in each direction. Market Flow is then further designated into two components: Firm Market Flow, which is energy flow related to contributions from the Network and Native Load serving aspects of the dispatch, and Non-Firm Market Flow, which is energy flow related to the Market-Based Operating Entity's market operations.

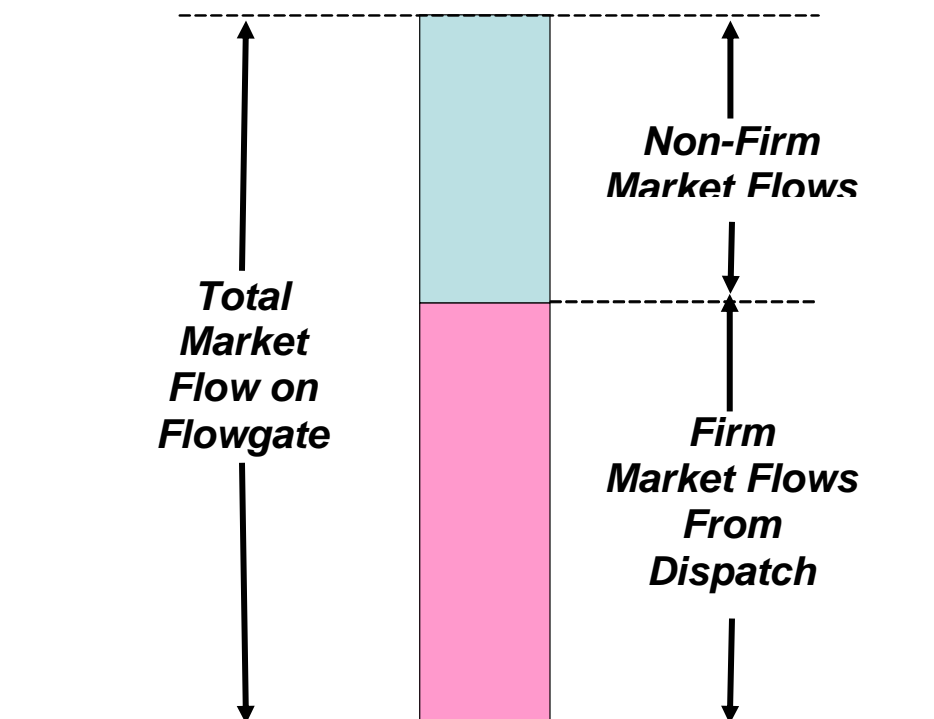

Note: Market flows equal generation to load flows in market areas.

Each Market-Based Operating Entity will calculate their actual real-time and projected directional Market Flows, as well as their directional Firm and Non-Firm Market Flows, on each Coordinated Flowgate. The following sections outline how these flows will be computed.

4.1 Market Flow Determination

The determination of Market Flows builds on the “Per Generator” methodologies that were developed by the NERC Parallel Flow Task Force. The “Per Generator Method Without Counter Flow” was presented to and approved by both the NERC Security Coordinator Subcommittee (SCS) and the Market Interface Committee (MIC).¹

Similar to the Per Generator Method, the Market Flow calculation method is based on Generator Shift Factors (GSFs) of a market area’s assigned generation and the Load Shift Factors (LSFs) of its load on a specific Flowgate, relative to a system swing bus. The GSFs are calculated from a single bus location in the base case (e.g. the terminal bus of each generator) while the LSFs are defined as a general scaling of the market area’s load. The Generator to Load Distribution Factor (GLDF) is determined through superposition by subtracting the LSF from the GSF.

The determination of the Market Flow contribution of a unit to a specific Flowgate is the product of the generator’s GLDF multiplied by the actual output (in megawatts) of that generator. The total Market Flow on a specific Flowgate is calculated in each direction; forward Market Flows is the sum of the positive Market Flow contributions of each generator within the market area, while reverse Market Flow is the sum of the negative Market Flow contributions of each generator within the market area.

For purposes of the Market Flow determination, the market area may be either: (1) the entire RTO footprint, as in the following illustration; or (2) a subset of the RTO region, such as a pre-integration NERC-recognized Control Area, as necessary to ensure accurate determinations and consistency with pre-integration flow determinations. Each Market-Based Operating Entity shall choose only one of these two options to calculate its Market Flows. With regard to the second option, the total Market Flow of an RTO shall be the sum of the flows from and between such market areas.

¹ “Parallel Flow Calculation Procedure Reference Document,” NERC Operating Manual. 11 Feb, 2003. www.nerc.com

Calculating the Market Flow Illustration

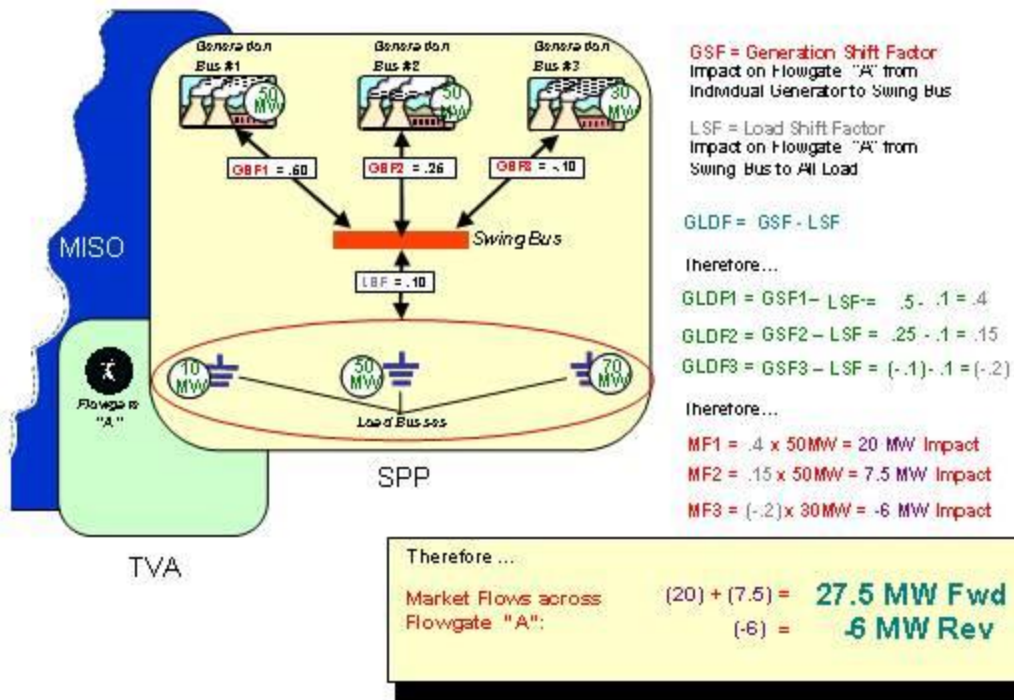

The Market Flow calculation differs from the Per Generator Method in the following ways:

- The contribution from all market area generators will be taken into account.
- In the Per Generator Method, only generators having a GLDF 5% or greater are included in the calculation. Additionally, generators are included only when the sum of the maximum generating capacity at a bus is greater than 20 MW. The Market Flow calculations will use all flows, in both directions, to calculate a Market Flow down to a 5% threshold and to calculate a Market Flow down to a 0% threshold. Forward flows and reverse flows are determined as discrete values.
- The contribution of all market area generators is based on the present output level of each individual unit.
- The contribution of the market area load is based on the present demand at each individual bus.

By expanding on the Per Generator Method, the Market Flow calculation evolves into a methodology very similar to the "Per Generator Method," while providing granularity on the order of the most granular method developed by the IDC Granularity Task Force.

Directional flows are required for this process to ensure a Market-Based Operating Entity can effectively select the most effective generation pattern to control the flows on both internal and external constraints, but are considered as distinct directional flows to ensure comparability with existing NERC and/or NAESB TLR processes. Under this process, the use of real-time values in concert with the Market Flow calculation effectively implements one of the more accurate and

detailed methods of the six IDC Granularity Options considered by the NERC IDC Granularity Task Force.

Each Market-Based Operating Entity shall choose one of the three methodologies set forth in Section 4.1.1 (*Methodologies to Account for Tagged Transactions*) below to account for import and export tagged transactions and shall apply it consistently for each of the following calculations:

1. the Market Flow calculation;
2. the Firm Flow Limit calculation;
3. the Firm Flow Entitlement calculation; and
4. the tagged transaction impact calculation which occurs in the IDC.

Market Flows represent the impacts of internal generation (including generators pseudo-tied into the market area and excluding generators pseudo-tied out of the market area) serving internal load (including load pseudo-tied into the market area and excluding load pseudo-tied out of the market area) and tagged grandfathered transactions within the market area. Market Flows shall not include the impacts from import tagged transaction(s) into and export tagged transaction(s) out of the market area where the impacts of the interchange transactions are accounted for by the IDC. A Market-Based Operating Entity shall utilize the IDC to calculate the impacts of import tagged transactions into and export tagged transactions out of the market area that are not captured in the Market Flow calculation. The impact of the EAR shall be included in the Market Flow calculation using the methodology selected in Section 4.1.1 (*Methodologies to Account for Tagged Transactions*); the related tags will be excluded in IDC. For an import EAR, load will be adjusted, and for an export EAR, generation will be adjusted, in accordance with the methodology selected in Section 4.1.1 (*Methodologies to Account for Tagged Transactions*).

Units assigned to serve a market area's load do not need to reside within the market area's footprint to be considered in the Market Flow calculation. Units outside of the market area that are pseudo-tied into the market to serve the market area's load will be included in the Market Flow calculation. However, units outside of the market area will not be considered when those units will have tags associated with their transfers (i.e., where pseudo-tie does not exist).

Additionally, there may be situations where the participation of a generator in the market that is not modeled as a pseudo-tie may be less than 100% (e.g., a unit jointly owned in which not all of the owners are participating in the market). This situation occurs when the generator output controlled by the non-participating parties is represented as interchange with a corresponding tag(s) and not as a pseudo-tie generator internal to each party's Control Area. Except for the generator output represented by qualifying interchange transactions from jointly owned units described in the following paragraph, such situations will be addressed by including the generator output in that Market-Based Operating Entity's Market Flow calculation with the amount of generator output not participating in the market being scaled down within the Market-Based Operating Entity's region or regions in accordance with one of the following three methodologies described and defined below in Section 4.1.1: the Marginal Zone Method, POR-POD Method, or Slice-of-System Method.

When a jointly owned unit, which is also listed as a Designated Network Resource for the Historic Firm Flow calculation, participates in more than one market, and the generator output from that unit between the two markets is represented as interchange with a corresponding tag(s) that is accounted for by the IDC and not as a pseudo-tie generator internal to each market's Control Area, its modeling in the Market Flow calculation will be aligned with that in the Historic Firm Flow calculation. The amount of generator output from that unit scheduled between the two markets will be treated as a unit-specific export tagged transaction in the Market Flow calculation of the Market-Based Operating Entity where the generator is located and will be treated as a load-specific import tagged transaction in the Market Flow calculation of the other Market-Based Operating Entity.

- For exports out of one market area associated with the jointly owned unit(s), the generator output of jointly owned unit will be scaled down by an amount which is the lesser of the corresponding export tagged transaction(s) and unit ownership of an owner participating in other market area.
- For imports into the other market area associated with the jointly owned external unit(s), the Control Zone load or bus load(s) will be scaled down by an amount which is the lesser of the corresponding import tagged transaction(s) and unit ownership of an owner participating in the market area.

Import tagged transactions, export tagged transactions, and grandfathered tagged transactions within the market area, must be properly accounted for in the determination of Market Flows.

Below is a summary of the calculations discussed above.

For a specified Flowgate, the Market Flow impact of a market area is given as:

Total Directional “Market Flows” = \sum (Directional “Market Flow” contribution of each unit in the Market-Based Operating Entity’s area), grouped by impact direction

where,

“Market Flow” contribution of each unit in the Market-Based Operating Entity’s area = $(GLDF_{Adj})$ (Adjusted Real-Time generator output)

and,

$GLDF_{Adj}$ is the Generator to Load Distribution Factor

Where the generator shift factor (GSF_{Adj}) uses Adjusted Real-Time generator output and the load shift factor (LSF_{Adj}) uses Adjusted Real-Time bus loads.

$GLDF_{Adj} = GSF_{Adj} - LSF_{Adj}$

Adjusted Real-Time generator output is the output of an individual generator as reported by the state estimator solution that has been adjusted for exports associated with joint ownership, if any, and then further adjusted for the remaining exports utilizing the chosen methodology in Section 4.1.1.

Adjusted Real-Time bus load is the sum of all bus loads in the market as reported by the state estimator solution that have been adjusted for imports associated with joint ownership, if any, and then further adjusted for the remaining imports utilizing the chosen methodology in Section 4.1.1.

The real-time and one-hour ahead projected “Market Flows” will be calculated on-line utilizing the Market-Based Operating Entity’s state estimator model and solution. This is the same solution presently used to determine real-time market prices as well as providing on-line reliability assessment and the periodicity of the Market Flow calculation will be on the same order. Inputs to the state estimator solution include the topology of the transmission system and actual analog values (e.g., line flows, transformer flows, etc...). This information is provided to the state estimator automatically via SCADA systems such as NERC’s ISN link.

Using an on-line state estimator model to calculate “Market Flows” provides a more accurate assessment than using an off-line representation for a number of reasons. The calculation incorporates a significant amount of real-time data, including:

- **Actual real-time and projected generator output.** Off-line models often assume an output level based on a nominal value (such as unit maximum capability), but there is no guarantee that the unit will be operating at that assumed level, or even on-line. Off-line models may not reflect the impact of pumped-storage units when in pumping mode; these units may be represented as a generator even when pumping. Additionally off-line models may not reflect the impact of units such as wind generators. A real-time calculation explicitly represents the actual operating modes of these units.
- **Actual real-time bus loads.** Off-line assessments may not be able to accurately account for changes in load diversity. Off-line models are often based on seasonal winter and summer peak load base cases. While representative of these peak periods, these cases may not reflect the load diversity that exists during off-peak and shoulder hours as well as off-peak and shoulder months. A real-time calculation explicitly accounts for load diversity. Off-line assessments may also reflect load reduction programs that are only in effect during peak periods.
- **Actual real-time breaker status.** Off-line assessments are often bus models, where individual circuit breakers are not represented. On-line models are typically node models where switching devices are explicitly represented. This allows for the real-time calculation to automatically account for split bus conditions and unusual topology conditions due to circuit breaker outages.

Additionally, the calculation rate of the on-line assessment is much quicker and accurate than an off-line assessment, as the on-line assessment immediately incorporates changes in system topology and generators. Facility outages are automatically incorporated into the real-time assessment.

In order to provide reliable and consistent flow calculations, entities utilizing this process as the basis for coordination must ensure that the modeling data and assumptions used in the calculation process are consistent. Reciprocal Entities will coordinate models to ensure similar computations and analysis. Reciprocal Entities will each utilize real-time ICCP and ISN data for observable areas in each of their respective state estimator models and will utilize SDX data for areas outside the observable areas to ensure their models stay synchronized with each other and the EIDSN IDC.

4.1.1 Methodologies to Account for Tagged Transactions

A Market-Based Operating Entity shall choose one of the following methodologies to account for export and import tagged transactions in the Market Flow calculation utilized for market-to-market, and shall also use the same methodology to account for export and import tagged transactions in the Firm Flow Limit and Firm Flow Entitlement calculations, as well as calculated tag impacts by the IDC:

1. Point-of-receipt (POR) / point-of-delivery (POD) Method (POR-POD Method) - Export tagged transactions, excluding tagged transactions associated with jointly owned units participating in more than one market shall be accounted for based on the POR of the transmission service reservation, as the transmission service was originally sold, that is listed on the export tagged transaction by proportionally offsetting the MW output of all units (i) in the Market-Based Operating Entity's Control Area, (ii) pre-integration NERC-recognized Control Area(s), or (iii) sub-regions within its Control Area. Import tagged transactions, excluding tagged transactions associated with jointly owned units participating in more than one market shall be accounted for based on the POD of the transmission service reservation, as the transmission service was originally sold, that is listed on the export tagged transaction by proportionally offsetting the MW load of all load buses (i) in the Market Based Operating Entity's Control Area, (ii) pre-integration NERC-recognized Control Area(s), or (iii) sub-regions within the Control Area; or
2. Marginal Zone Method – Export tagged transactions, excluding tagged transactions associated with jointly owned units participating in more than one market shall be accounted for by adjusting the MW output of the units in the Market-Based Operating Entity's Control Area, regions, or subregions within its Control Area by the total MW amount of all the Market-Based Operating Entity's export tagged transactions excluding tagged transactions associated with jointly owned units participating in more than one market using: (1) marginal zone participation factors, as defined and calculated in Appendix B (*Determination of Marginal Zone Participation Factors*); and (2) the anticipated availability of a generator to participate in the interchange of the marginal zone. Import tagged transactions, excluding tagged transactions associated with jointly owned units participating in more than one market shall be accounted for by adjusting the MW load of the load buses in the Market-Based Operating Entity's Control Area, regions or subregions within the Control Area, by the total MW amount of all the Market-Based Operating Entity's import tagged transactions excluding tagged transactions associated with jointly owned units participating in more than one market using marginal zone participation factors, as defined and calculated in Appendix B (*Determination of Marginal Zone Participation Factors*); or
3. Slice of System Method – Export tagged transactions, excluding tagged transactions associated with jointly owned units participating in more than one market shall be accounted for by proportionately adjusting the MW output of each of the units in the Market-Based Operating Entity's Control Area by the total MW amount of all the Market-Based Operating Entity's export tagged transactions excluding tagged transactions associated with jointly owned units participating in more than one market. Import tagged transactions, excluding tagged transactions associated with jointly owned units participating in more than one market shall be accounted by proportionately

adjusting the MW load of each of the load buses in the Market-Based Operating Entity's Control Area by the total MW amount of all the Market-Based Operating Entity's import tagged transactions excluding tagged transactions associated with jointly owned units participating in more than one market.

Each Market-Based Operating Entity shall post and maintain a document on its public website that describes calculations and assumptions used in those calculations regarding the chosen methodology and its application to the treatment of import and export transactions to the calculation of Market Flows, Firm Flow Limits, and Firm Flow Entitlements, and tag impacts calculated by the IDC.

4.2 Firm Flow Determination

Firm Flows represent the directional sum of flows created by Designated Network Resources serving designated network loads within a particular market area. They are based primarily on the configuration of the system and its associated flow characteristics; utilizing generation and load values as its primary inputs. Therefore, these Firm Flows can be determined based on expected usage and the Allocation of Flowgate capacity.

An entity can determine Firm Flows on a particular Flowgate using the same process as utilized by the IDC. This process is summarized below:

1. Utilize a reference base case to determine the Generation Shift Factors for all generators in the current Control Areas' respective footprints to a specific swing bus with respect to a specific Flowgate.
2. Utilize the same base case to determine the Load Shift Factors for the Control Area's load to a specific swing bus with respect to that Flowgate.
3. Utilize superposition to calculate the Generation to Load Distribution Factors (GLDF) for the generators with respect to that Flowgate.
4. Multiply the expected output used to serve native load from each generator by the appropriate GLDF to determine that generator's flow on the Flowgate.
5. Sum these individual contributions by direction to create the directional Firm Flow impact on the Flowgate.

4.3 Determining the Firm Flow Limit

Given the Firm Flow determinations described in the previous section, Market-Based Operating Entities can assume them to be their Firm Flow Limits. These limits define the maximum value of the GTL flows that can be considered as firm in each direction on a particular Flowgate in the IDC, and the maximum value of the Market Flows that can be considered firm on a particular flowgate for market-to-market. Prior to real-time, a calculation will be done based on updated hourly forecasted loads and topology. The results should be an hourly forecast of directional Firm Flows.

4.4 Firm Flow Limit Calculation Rules

The Firm Flow Limits for both 0% GTL flows and 5% GTL flows will be calculated for each Market Based Operating Entity based on certain criteria and rules. The calculation will include the effects of firm network service in both forward and reverse directions. The process will be similar to that of the IDC but will include one set of impacts down to 0% and another set down to 5%. The down to 0% impacts will be used to determine Firm Flow Limits on 0% GTL flows. The down to 5% impacts will be used to determine Firm Flow Limits on 5% GTL flows. The following points form the basis for the calculation.

1. The generation-to-load calculation will be made on a Control Area basis. The impact of generation-to-load will be determined for Coordinated Flowgates.
2. The Flowgate impact will be determined based on individual generators serving aggregated CA load. Only generators that are Designated Network Resources for the CA load will be included in the calculation.
3. Forward Firm Flow Limits for 0% GTL flows will consider impacts in the additive direction down to 0%, and reverse Firm Flow Limits for 0% GTL flows will consider impacts in the counter flow direction down to 0%. Forward Firm Flow Limits for 5% GTL flows will be determined by subtracting impacts between 0% and 5% in the additive direction from the Forward Firm Flow Limit for 0% GTL flows. Reverse Firm Flow Limits for 5% GTL flows will be determined by subtracting the impacts between 0% and 5% in the counter-flow direction from the reverse Firm Flow Limit for 0% GTL flows. Flowgate Firm Flow Limits using a 5% threshold are reported to the IDC for it to assign the Firm and non-Firm GTL flows used in TLR curtailments for each Market Based Operating Entity. Flowgate Firm Flow Limits using a 0% threshold are reported to the IDC for information purposes.
4. Designated Network Resources located outside the CA will not be included in the generation-to-load calculation if OASIS reservations exist for these generators.
5. If a generator or a portion of a generator is used to make off-system sales that have an OASIS reservation, that generator or portion of a generator should be excluded from the generation-to-load calculation.
6. Generators that will be off-line during the calculated period will not be included in the generation-to-load calculation for that period.
7. CA net interchange will be computed by summing all Firm Transmission Service reservations and all Designated Network Resources that are in effect throughout the calculation period. Designated Network Resources are included in CA net interchange to the extent they are located outside the CA and have an OASIS reservation. The net interchange will either be positive (exports exceed imports) or negative (imports exceed exports).
8. If the net interchange is negative, the period load is reduced by the net interchange.
9. If the net interchange is positive, the period load is not adjusted for net interchange.

10. The generation-to-load calculation will be made using generation-to-load distribution factors that represent the topology of the system for the period under consideration.
11. P_{MAX} of the generators should be net generation (excluding the plant auxiliaries) and the CA load should not include plant auxiliaries.
12. The portion of jointly owned units that are treated as schedules will not be included in the generation-to-load calculation if an OASIS reservation exists.

Section 5 – Market-Based Operating Entity Congestion Management

Once there has been an establishment of the Firm Flow Limit that is possible given Firm Market Flow calculation, that data will be used in the operating environment in a manner that relates to real-time energy flows.

5.1 Calculating Market Flows

On a periodic basis, the Market-Based Operating Entity will calculate directional Market Flows for all market-to-market Coordinated Flowgates. These flows will represent the actual flows in each direction at the time of the calculation.

5.2 Quantify and Provide Data for Firm Flow Limits

Every fifteen minutes, the Market-Based Operating Entity will be responsible for providing to Reliability Coordinators the following information:

- Firm Flow Limits for all Coordinated Flowgates in each direction
- Non-Firm Flow Limits for all Coordinated Flowgates in each direction

In real-time, any GTL flow in excess of the Firm Flow Limit will be reported as Non-Firm GTL flow (Priority 6-NN) (note that under reciprocal operations, some of this Non-Firm GTL flow may be quantified as Priority 2-NH).

These limits will be provided for both current hour and next hour, and is used to communicate to Reliability Coordinators the maximum amount of flows to be considered firm and non-firm on the various Coordinated Flowgates in each direction. When the Firm Flow Limit forecast is calculated to be greater than the GTL flow for current hour or next hour, all GTL flow is firm.

Additionally, as frequently as once an hour, but no less frequently than once every three months, the Market-Based Operating Entity will submit to the Reliability Coordinator sets of data describing the marginal units and associated participation factors for generation within the market footprint. The level of detail of the data may vary, as different Operating Entities will have different unique situations to address. However, this data will at a minimum be supplied for imports to and exports from the market area, and will contain as much information as is determined to be necessary to ensure system reliability. This data will be used by the Reliability Coordinators to determine the impacts of schedule curtailment requests when they result in a shift in the dispatch within the market area.

5.3 Day-Ahead Operations Process

The Market-Based Operating Entities will use a day-ahead operations process to establish the Firm Flow Limit on Coordinated Flowgates. If the Market-Based Operating Entities utilize a day-ahead unit commitment, they will supplement the day-ahead unit commitment with a security constrained economic dispatch tool, which uses a network analysis model that mirrors the real-time model found within their state estimators. As such, the day-ahead unit commitment and its associated Security Constrained Economic Dispatch respects facility limits and forecasted system constraints. Facility limits of Coordinated Flowgates under the functional control of Market-Based Operating Entities and the allocations of all Reciprocal Coordinated Flowgates will be honored.

For Coordinated Flowgates, a Market-Based Operating Entity can only use one of the following two methods to establish Firm Flow Limit. A Market-Based Operating Entity must use either the day-ahead unit commitment and its associated Security Constrained Economic Dispatch, or a Market-Based Operating Entity's GTL and unused Firm Transmission Service impacts, up to the Flowgate Limit, on the Coordinated Flowgate. At any given time, a Market-Based Operating Entity must use only one method for all Coordinated Flowgates and must give ninety days notice to all other Reciprocal Entities, if it decides to switch from one method to the other method. On a case by case basis, with agreement by all Reciprocal Entities the ninety-day notice period may be waived.

5.4 Real-time Operations Process – Operating Entity Capabilities

Operating Entities' real-time EMSs have very detailed state estimator and security analysis packages that are able to monitor both thermal and voltage contingencies every few minutes. State estimation models will be at least as detailed as the IDC model for all the Coordinated and Reciprocal Coordinated Flowgates. Additionally, Reciprocal Entities will be continually working to ensure the models used in their calculation of Market Flow are kept up to date.

The Operating Entities submit various system measurements (load, generator outputs, control device status, etc.) from their state estimators and Unit Dispatch Systems (UDS) to the SDX in real-time. These measurements are used by the IDC to calculate both the actual and projected hour ahead flows (i.e., total GTL and tagged impact flows) on the Coordinated Flowgates. The IDC's calculations of system flows will utilize each Operating Entity's actual unit output, updated at least every 15 minutes on an established schedule.

5.5 Market-Based Operating Entity Real-time Actions

The Market-Based Operating Entity will upload the real-time and one-hour ahead projected Firm Flow Limits (7-FN) and Non-Firm Flow Limits (6-NN) on these Flowgates to the IDC every 15 minutes, as requested by the IDCWG and OATI (note that under reciprocal operations, some of this 6-NN may be quantified as Priority 2-NH). Firm Flow Limits will be calculated, down to five percent and down to zero percent, and uploaded to the IDC. When the real-time actual flow exceeds the Flowgate limit and the Reliability Coordinator, who has responsibility for that Flowgate, has declared a TLR 3a or higher, the IDC will determine tag curtailments and GTL relief obligations using a tag impact and GTL impact of 5% or greater. The Market-Based Operating Entity will respond to the GTL relief obligation by redispatching their system. Note the Market-Based Operating Entity may provide relief through either: (1) a reduction of flows on the Flowgate in the direction required, or (2) an increase of reverse flows on the Flowgate.

Operating Entities will make any point-to-point transaction curtailments as specified by the IDC. Additionally, Market-Based Operating Entities will implement this redispatch by binding the Flowgate as a constraint in their Unit Dispatch System (UDS). UDS calculates the most economic solution while simultaneously ensuring that each of the bound constraints is resolved reliably.

The Reliability Coordinator calling the TLR will be able to see the relief provided on the Flowgate in both their EMS and in the IDC, as the IDC GTL calculation will reflect the redispatch of the Operating Entities with relief obligations through their real-time measurements submission.

Section 6 - Reciprocal Operations

Reciprocal Coordination Agreements can be executed on a market-to-market basis, a market-to-non-market basis, and a non-market-to-non-market basis. While the congestion management portions of this document are intended to apply specifically to Market-Based Operating Entities, the agreement to allocate Flowgate capability is not dependent on an entity operating a centralized energy market. Rather, it simply requires that a set of Flowgates be defined upon which coordination shall occur and an agreement to perform such coordination.

6.1 Reciprocal Coordinated Flowgates

In order to coordinate congestion management on a proactive basis, Operating Entities may agree to respect each other's Flowgate limitations during the determination of AFC/ATC and the calculation of firmness during real-time operations. Entities agreeing to coordinate this future-looking management of Flowgate capacity are Reciprocal Entities. The Flowgates used in that process are Reciprocal Coordinated Flowgates.

6.2 The Relationship Between Coordinated Flowgates and Reciprocal Coordinated Flowgates

Coordinated Flowgates are associated with a specific Operating Entity's operational sphere of influence. Reciprocal Coordinated Flowgates are associated with the implementation of a Reciprocal Coordination Agreement between two Reciprocal Entities. By virtue of having executed such an agreement, a Flowgate Allocation can occur between these two Reciprocal Entities as well as all other Reciprocal Entities that have executed Reciprocal Coordination Agreements with at least one of these two Reciprocal Entities. When considering an implementation between two Reciprocal Entities, it is generally expected that each of the Reciprocal Coordinated Flowgates will meet the following three criteria:

- It will meet the criteria for Coordinated Flowgate status for both the Reciprocal Entities,
- It will be under the functional control of one of the two Reciprocal Entities and
- Both Reciprocal Entities have executed Reciprocal Coordination Agreements either with each other or with a Third Party Reciprocal Entity.

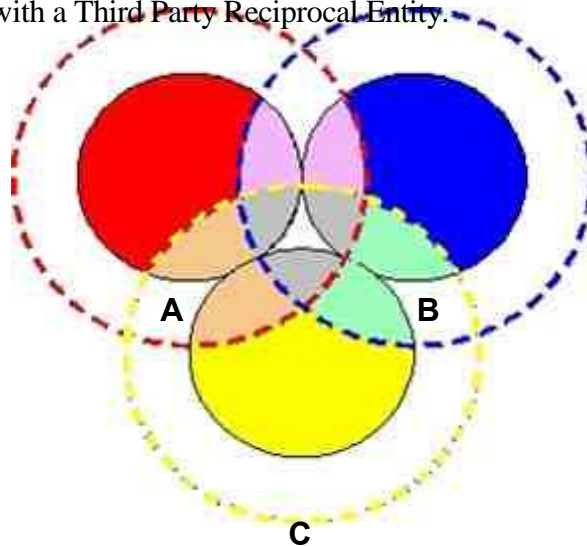

As shown in the illustration above, Operating Entity A, Operating Entity B and Operating Entity C each have their own set of Coordinated Flowgates (represented by the blue, yellow and red dotted-line circles). Where those sets of Coordinated Flowgates overlap AND they are in either Operating Entity A's, Operating Entity B's or Operating Entity C's service territory (the gray area), they will be considered Reciprocal Coordinated Flowgates between all three entities. Where those sets of Coordinated Flowgates overlap AND they are in either Operating Entity A's or Operating Entity B's service territory (the purple area), they will be considered Reciprocal Coordinated Flowgates between Operating Entity B and Operating Entity A only. Where those sets of Coordinated Flowgates overlap AND they are in either Operating Entity B's or Operating

Entity C's service territory (the green area), they will be considered Reciprocal Coordinated Flowgates between Operating Entity B and Operating Entity C only. Where those sets of

Coordinated Flowgates overlap AND they are in either Operating Entity A's or Operating Entity C's service territory (the orange area), they will be considered Reciprocal Coordinated Flowgates between Operating Entity A and Operating Entity C only.

To the extent that entities other than Market-Based Operating Entities may enter into a Reciprocal Coordination Agreements, they may offer to coordinate on Flowgates that are Coordinated Flowgates (i.e., have passed one of the five tests defined within this document or otherwise been deemed to be a Coordinated Flowgate).

6.3 Coordination Process for Reciprocal Flowgates

The following process and timing will be used for coordinating the ATC/AFC calculations and Firm Flow Limit calculations/Allocations between Reciprocal Entities. Further, the process quantifies and limits Priority 6 – NN service on the Reciprocal Coordinated Flowgates, as well as determines priority 2-NH service. All Reciprocal Entities' Firm Flow Limits will be calculated on the same basis.

6.4 Calculating Historic Firm Flows

As a starting point for identifying Allocations, an understanding must be developed of what Firm Flows would be in the historic Control Area structure. In other words, there must be a quantification of the Firm Flows that would have occurred if all Control Areas maintained their current configuration and continued to: (1) serve their native load with their Designated Network Resources, and (2) import and export energy at historical levels (based upon Firm Transmission Service reservations as of the Freeze Date, which is currently set as April 1, 2004). This flow is referred to as Historic Firm Flow.

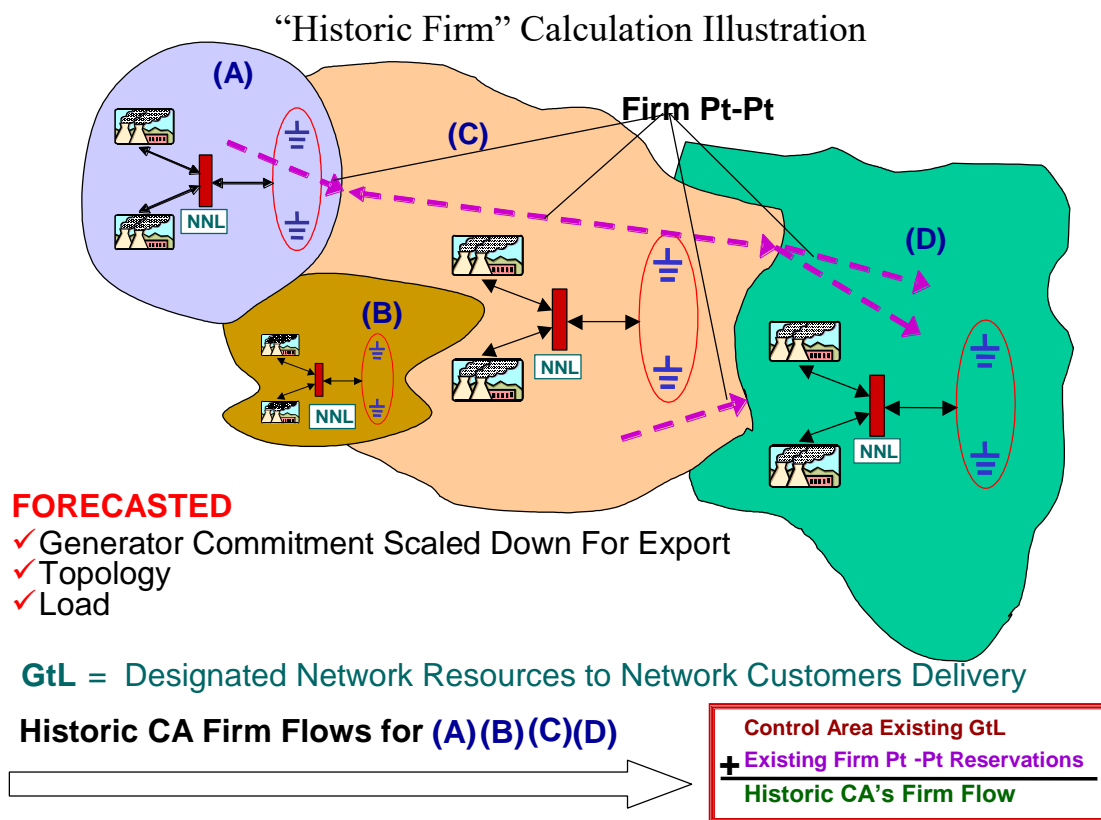

Reciprocal Entities will utilize the IDC Base Case model, or a mutually agreed upon alternative model as the reference base case for these calculations.

6.5 Recalculation of Initial Historic Firm Flow Values and Ratios

The Firm Transmission Service and Designated Network Resource to customer load defined by the Historic Firm Flow calculation will be updated in the recalculation of Historic Firm Flow utilizing any new Designated Network Resources, updated customer loads, and new transmission facilities. The original historic Control Areas will be retained for the recalculation of Historic Firm Flow. New Designated Network Resources will be included in the recalculation to the extent these new Designated Network Resources have been arranged for the exclusive use of load within the historic Control Areas and to the extent the total impact of all Designated Network Resources does not exceed the historic Control Area impact of Designated Network Resources as of a “Freeze Date” (defined as April 1, 2004). Any changes to Designated Network Resources and/or the transmission system that increase transmission capability will be assessed in accordance with the Reciprocal Entities AFC Coordination procedures prior to the increasing of Historic Firm Flow related to those systems.

The initial Historic Firm Flow calculated values and resulting Allocation ratios will be recalculated as seasonal cases are produced. This recalculation will utilize the same Firm Transmission Service reservations that were used in the initial Historic Firm Flow calculation. The same Firm Transmission Service reservations are used so that Market-Based Operating Entities that have their Firm Transmission Service internalized, grant fewer internal Firm Transmission Service reservations, or have their original Firm Transmission Service reservations end, because of their market operations, will retain at least the same level of Firm Transmission Service as in the initial Historic Firm Flow calculation. Therefore, the Firm Transmission Service component of the Historic Firm Flow will be frozen on the “Freeze Date” at the initially calculated level for both market and non-market entities.

Any new Control Areas that are added to the Firm Flow calculation process for any Reciprocal Entity, or another Operating Entity, will use Firm Transmission Service reservations from the initial Historic Firm Flow calculation date to establish their Firm Transmission Service component of the Historic Firm Flow.

As the recalculation for Historic Firm Flow is made for each time period, the higher of allocation value will be retained between the initial Historic Firm Flow calculation and the recalculation (See “Forward Coordination Process” Section 6.6, step 8.f). To the extent an Operating Entity has made commitments based on the higher of Allocation value, a recalculation does not reduce previously calculated Allocations.

When a Flowgate experiences a transitory limit reduction or de-rating, there will be no change made to the historic allocations. In effect, the Operating Entity responsible for the Flowgate is expected to absorb the impact of the de-rating by not reducing the historic allocation of the other Operating Entities. This practice is consistent with the use of the higher-of logic in the historic allocation process. Where a change in system conditions, such as a significant transmission outage, affects flows on a longer term basis the Reciprocal Entities will discuss whether historic allocations, including an over-ride of the higher-of logic, should be rerun to recognize the effects of the change in system conditions in the historic allocations. The historic allocations shall be rerun only if the affected Reciprocal Entities mutually agree.

6.6 Forward Coordination Processes

1. For each Reciprocal Coordinated Flowgate, a managing entity and an owning entity will be defined. The manager will be responsible for all calculations regarding that Flowgate; the owner will define the set of Firm Transmission Service reservations to be utilized when determining Firm Transmission Service impacts on that Flowgate.
2. Managing entities will calculate both Historic Firm Gen-to-Load Flow impacts and historic Firm Transmission Service impacts for all entities. These impacts will be used to define the Historic Ratio and the Allocation of transmission capability.
3. The managing entity will utilize the current IDC Base Case (or other mutually agreeable base case) to determine impacts. The case should be updated with the most current set of outage data for the time period being calculated.
4. Managing entities will calculate Allocations on the following schedule:

Allocation Run Type	Allocation Process Start	Range Allocated	Allocation Process Complete
April Seasonal Firm	Every April 1 at 8:00 EST	Twelve monthly values from October 1 of the current year through September 30 of the next year	April 1 at 12:00 EST
October Seasonal Firm	Every October 1 at 8:00 EST	Twelve monthly values from April 1 of next year through March 31 of the following year	October 1 at 12:00 EST
Monthly Firm	Every month on the second day of the month at 8:00 EST	Six monthly values for the next six successive months	2 nd of the month at 12:00 EST
Weekly Firm	Every Monday at 8:00 EST	Seven daily values for the next Monday through Sunday	Monday at 12:00 EST
Two-Day Ahead Firm	Every Day at 17:00 EST	One daily value for the day after tomorrow	Current Day at 18:00 EST
Day Ahead Non-Firm	Every Day at 8:00 EST	Twenty-four hourly values for the next 24-hour period (Next Day HE1-HE24 EST)	Current Day at 9:00 EST

5. Historic Ratios are defined during the seasonal runs the first time an impact is calculated. For example, the 2004 April seasonal firm run would define the Historic Ratio for April 2005 – September 2005 (October through March would have been calculated during the 2003 October seasonal firm run). The Historic Ratio is based on the total impacts of the Reciprocal Entity on the Flowgate (Historic Firm Gen-to-Load Flows and historic Firm Transmission Service flows, down to 0%) relative to the total impacts of all other Reciprocal Entities' impacts on the Flowgate. For example, if Reciprocal Entity A had a 30 MW impact on the Flowgate and Reciprocal Entity B had a 70 MW impact on the Flowgate, the Historic Ratios would be 30% and 70%, respectively.

6. The same rules defined in the “Market-Based Operating Entity Congestion Management” Section 5 of this document for use in determining Firm Transmission Service impacts (NNL) shall apply when performing Allocations.
7. Additional rules to be used when considering Firm Transmission Service impacts are defined later within this section.
8. For each firm Allocation run described above, the managing entity will take the following steps to determine Allocations down to 0% for each of the Flowgates, in both the forward and reverse direction, they are assigned to manage:
 - a. Retrieve the Flowgate limit
 - b. Subtract the current Transmission Reliability Margin (TRM) value (may be zero)
 - c. Subtract the sum of all historically determined Firm Flow impacts for all entities based on impacts greater than or equal to 5%
 - d. Accommodation of Capacity Benefit Margin (CBM)
 - If no capacity remains after step (c), entities’ firm Allocation is limited to this amount (i.e., their Firm Flow impacts from impacts of 5% or greater), and the firm Allocation for the entity with functional control over the Flowgate is increased by the current CBM value (may be zero).
 - If capacity does remain after step (c), and the sum of all Reciprocal Entities’ impacts below 5% plus CBM is less than the remaining capacity from step (c), that capacity is allocated to the Reciprocal Entities pro-rata based on their Firm Flow impacts due to impacts less than 5% up to the total amount of their Firm Flow impacts due to impacts less than 5%.
 - If there is not sufficient capacity for all impacts below 5% plus CBM to be accommodated, the current CBM value is subtracted from the remaining capacity from step (c), and granted to the entity with functional control over the Flowgate. Any capacity remaining is allocated to the Reciprocal Entities pro-rata based on their Firm Flow impacts due to impacts less than 5%.
 - e. Any remaining capacity, after step (d) will be considered firm and allocated to Reciprocal Entities based on their Historic Ratio (as described in step 5). If the remaining capacity allocated to the entity with functional control over the Flowgate meets or exceeds the current CBM value, no further effort is needed. If the remaining capacity is less than the CBM, capacity will first be reduced by the CBM, and the entity with functional control over the Flowgate will be granted the capacity needed to support the CBM. In addition each Reciprocal Entity (including the entity with functional control over the Flowgate) will receive allocations determined as a pro-rata share of the remaining capacity (as described in Step 5).
 - f. Upon completion of the Allocation process, the managing entity will compare the current preliminary Allocation to the previous Allocations. For any given Flowgate, the larger of the Allocations will be considered the Allocation (i.e., an Allocation cannot decrease). Once all preliminary Allocations have been compared and the final Allocation determined, the managing entity will distribute the Allocations to the appropriate Reciprocal Entities. This Allocation will consist of the firm Gen-to-Load limit and a portion of capability that can be used either for Firm Transmission Service or additional firm Gen-to-Load service.

9. For the non-firm Allocation run described above, the managing entity will take the following steps to determine Allocations down to 0% for each of the Flowgates, in both the forward and reverse direction, they are assigned to manage. For each hour, the managing entity shall:
 - a. Retrieve the Flowgate limit
 - b. Subtract the current TRM value (may be zero)
 - c. Subtract the sum of all hourly historically determined Firm Flow impacts for all entities based on impacts greater than or equal to 5%
 - d. Subtract the sum of all hourly historically-determined Firm Flow impacts for all Reciprocal Entities based on impacts less than 5%.
 - e. Any remaining capacity will be allocated to Reciprocal Entities based on their Historic Ratio (as described in step 5).
 - f. The two-day ahead firm Allocation is subtracted from the total entity Allocation (from steps c, d, and e).
 - If the result is positive, this value will be equivalent to the Priority 6-NN Allocation/limit, and the Firm Flow Limit for 0% Market Flows will be the two-day ahead firm Allocation.
 - If the result is negative or zero, the Priority 6-NN Allocation will be calculated by subtracting the total entity Allocation (from steps c, d and e) from the two-day ahead firm Allocation. The Firm Flow Limit for 0% Market Flows will be the equivalent of the total entity allocation.
 - g. Upon completion of the Allocation process, the managing entity will distribute the Allocations to the appropriate Reciprocal Entities. These Allocations will be considered non-firm network service.

When a Market-Based Operating Entity is uploading Firm Flow Limits to the IDC, they will be responsible for ensuring that any firm Allocations are properly accounted for. If firm Allocations are used to provide additional firm network service, they should be included in the Firm Flow Limit. If they are used to provide additional Firm Transmission Service, they should not be included in the Firm Flow Limit.

The Market-Based Operating Entities will maintain in real-time their Firm Transmission Service and Network Non-Designated service impacts, within their respective firm and Priority 6 total Allocations. The Firm Transmission Service impacts will be based on schedules. The Operating Entities participating in the Coordinated Process for Reciprocal Flowgates will respect their allocations when granting Firm Transmission Service.

Using the derived firm Allocation value, the Market-Based Operating Entity may choose to enter this value as a Flowgate limit for the respective Flowgate. If entered as a Flowgate limit, the Day-Ahead unit commitment will not permit flows to exceed this value as it selects units for this commitment. Market-Based Operating Entities will use the Flowgate limit to restrict unit outage scheduling for a Coordinated Flowgate when maintenance outage coordination indicates possible congestion and there is recent TLR activity on a Flowgate.

As Reciprocal Entities gain more experience in this process, implement and enhance their systems to perform the Firm Flow calculations and Allocations, they may change the timing requirements for the Forward Coordination Process by mutual agreement.

6.6.1 Determining Firm Transmission Service Impacts

Firm impacts used in the Allocation process incorporate the Firm Transmission Service flows. Similar to the network service calculation described previously, to calculate each Firm Transmission Service transaction's impact on the Flowgate, the following process is utilized:

1. Utilize a base case to determine the Generation Shift Factor for the source Control Area with respect to a specific Flowgate.
2. Utilize the same base case to determine the Generation Shift Factor for the sink Control Area with respect to that Flowgate.
3. Utilize superposition to calculate the TDF for that source to sink pair with respect to that Flowgate.
4. Multiply the transactions energy transfer by the TDF to determine that transactions flow on the Flowgate.

Summing each of these impacts by direction will provide the directional Firm Transmission Service impact on the Flowgate.

Combining the directional Firm Transmission Service impacts with the directional NNL impacts will provide the directional Firm Flows on the Flowgate.

6.6.2 Rules for Considering Firm Transmission Service

1. Firm Transmission Service and Designated Network Resources that have an OASIS reservation are included in the calculation.
2. Reciprocal Entities will utilize a Freeze Date of April 1, 2004. Reciprocal Entities will utilize a reference year of June 1, 2004 through May 31, 2005 for determining the confirmed set of reservations that will be used in the Allocation process. The reference year is used such that reservation impacts in a given month in the reference year are used for each comparable month going forward in the Allocation process. For example, the Allocations for July 2004, July 2005, and July 2006 etc. will always use the July 2004 reservation impacts from the reference year. Confirmed reservations received after the Freeze Date will not be considered.
3. A potential for duplicate reservations exists if a transaction was made on individual CA tariffs (not a regional tariff) and both parties to the transaction (source and sink) are Reciprocal Entities. In this case, each Reciprocal Entity will receive 50% of the transaction impact.
4. To the extent a partial path reservation is known to exist, it will have 100% of its impacts considered on Reciprocal Coordinated Flowgates owned by the party that sold the partial path service, split 50/50 between the Source Reciprocal Entity and the Sink Reciprocal Entity, and 0% of its impacts considered on other Reciprocal Coordinated Flowgates.
5. Because reservations that are totally within the footprint of the regional tariff do not have duplicate reservations, these reservations will have the full impact considered even

though both parties to the transaction (source and sink) are within the boundaries of the regional tariff and will be considered Reciprocal Entities, split 50/50 between the Source Reciprocal Entity and the Sink Reciprocal Entity, which in this case are the same. Similar to the firm network service calculation, the Firm Transmission Service calculation:

- a. Will consider all reservations (including those with less than 5% impact)
- b. Will base response factors on the topology of the system for the period under consideration.
- c. In general, will not make a generation-to-load calculation where a reservation exists.

6.6.3 Limiting Firm Transmission Service

The Flowgate Allocations down to 0% will represent the share of total Flowgate capacity (STFC) that a particular entity has been allocated. This STFC represents the maximum total impact that entity is allowed to have on that Flowgate.

In order to coordinate with the existing AFC process, it is necessary that this number be converted to an available STFC (ASTFC) which represents how much Flowgate capability remains available on that Flowgate for use as Transmission Service. In order to accomplish this, the entity receiving STFC will do the following:

Step	Example
1.) Start with the STFC	100
2.) Add all forward Gen to Load impacts (down to 0%) and all Reverse Gen to Load impacts (down to 0%) to obtain the Net Gen to Load impacts. The Gen to Load impacts should be based on the <i>best estimate</i> of firm Gen-to-Load Flow for the time period being evaluated.	$42 + (-20) = 22$
3.) Subtract the net Gen to Load impacts from the STFC	$100 - 22 = 78$
4.) Subtract the CBM to produce an interim STFC	$78 - 0 = 78$
5.) Determine the Transmission Service impacts of service that has been sold. By default, it should be assumed that 100% of forward service and 15% of counterflowing service will be scheduled and used. However, if Flowgate "owner" uses different percentages in their AFC calculation and the Flowgate manager's calculation	$58 + (0.15 (-45)) =$ $58 + (-6.75) \approx$ $58 + (-7) = 51$

<p>engine support it, percentages other than 100% and 15% may be used. Add all forward Transmission Service impacts (down to 0%) and all appropriate reverse Transmission Service impacts (down to 0%) to obtain the weighted net Transmission Service impacts. The Transmission Service impacts should be based on the <i>current</i> set of reservations in effect for the time period being evaluated (<i>not</i> the historic reservation set)</p>	
<p>6.) Subtract the weighted net Transmission Service impacts from the Interim STFC. The result is the ASTFC</p>	<p>$78 - 51 = 27$</p>

The ASTFC values for Reciprocal Coordinated Flowgates will be posted on OASIS along with the Allocation results. This ASTFC can then be compared with the AFC calculated through traditional means when evaluating firm requests made on OASIS.

If the AFC value is LOWER than the ASTFC value, the AFC value should be utilized for the purpose of approving/denying service. In this case, while the Allocation process might indicate that the entity has rights to a particular Flowgate through the Allocation process, current conditions on that Flowgate indicate that selling those rights would result in overselling of the Flowgate, introducing a reliability problem.

If the AFC value is HIGHER than the ASTFC value, the ASTFC value should be utilized for the purpose of approving/denying service. In this case, while the AFC process might indicate that the entity can sell more service than the Allocation might indicate, the entity is bound to not sell beyond their Allocation.

If a Reciprocal Entity uses all of its firm Allocation and desires to obtain additional capacity from another Reciprocal Entity who has remaining capacity, that additional capacity may be obtained using the procedures documented below.

6.7 Sharing or Transferring Unused Allocations

Reciprocal Entities shall use the following process for the sharing or transferring of unused Allocations down to 0% between each other.

6.7.1 General Principles

This process includes the following general principles in the treatment of unused Allocations

1. A desire to fully utilize the Reciprocal Entities' Allocations such that in real-time, an unused Allocation by Reciprocal Entities is caused by a lack of commercial need for the Allocation by Reciprocal Entities and not by restrictions on the use of the Allocation.
2. For short-term requests (less than one year) where the lack of an Allocation could otherwise result in the denial of Transmission Service requests, there should be a mechanism to share or acquire a remaining Allocation on a non-permanent basis for the duration of the short-term transmission service requests. The short-term Allocation transfers would revert back to the Reciprocal Entity with the original Allocation after the short term request expires.
3. For long-term requests (one year or longer) where the lack of an Allocation could otherwise cause the construction of new facilities, there should be a mechanism to acquire a remaining Allocation such that new facilities are built only because they are needed by the system to support the transaction and not because of the Allocation split between Reciprocal Entities. Long-term Allocation transfers would apply to the original time period of the request including any roll-over rights that are granted for such requests.
4. Due to limitations on the frequency of transferring updated Allocation values and AFC's between the Reciprocal Entities, the Reciprocal Entities will utilize buffers to reduce the risk of overselling the same service, and to set aside a portion of the unused Allocation for the owner of the unused Allocation to accommodate any request that they may receive. The buffer will be reduced on a Flowgate based upon factors such as the rating of the Flowgate and operational experience, with the goal to maximize the use of the unused Allocation. The rationale for reducing the buffer is that potentially significant amounts of Transmission Service (up to many times the buffer amount) may be denied otherwise by the non-owner of the unused Allocation.

6.7.2 Provisions for Sharing or Transferring of Unused Allocations:

1. Based upon the proposed infrastructure for Allocation calculations, daily Allocations are available for 7 days into the future and Weekly and Monthly Allocations are available up to 18 months into the future. Sharing and transferring of unused Allocations will be limited to the granularity of the Allocation calculations.

2. The Reciprocal Entities will share or transfer their unused firm Allocations during the time periods up until day ahead with the goal to fully utilize the Allocations.
3. This sharing or transfer of the unused Allocation will occur automatically for short-term Transmission Service requests, and manually for long-term (one year or greater) Transmission Service requests. The Reciprocal Entity that has been requested to transfer unused Allocations to the other Reciprocal Entity for a long-term request shall respond within 5 business days of receipt of the transfer request.
4. The Reciprocal Entities will post information available to the other Reciprocal Entity on all requests granted that shared or acquired the other Reciprocal Entity's Allocation on a daily basis for review.
5. Sharing an Unused Allocation During the Near-Term

The Reciprocal Entities will share their Allocations during the near-term (the first 7 days up until day ahead or a mutually agreed upon timeframe) with the goal to fully utilize the Allocations once in real-time through an automated process.

This sharing of the unused Allocation during the near-term will occur such that an unused Allocation that has not already been committed for use by either Firm Transmission Service or for market service will be made available to the other Reciprocal Entities for their use to accommodate Firm Transmission Service requests submitted on OASIS.

Other firm uses of the transmission system involving generation to load deliveries, which are not evaluated via automated request evaluation tools, will be handled via off-line processes. The core principles to be applied in such cases include:

- a. A sharing of Allocation can occur.
- b. The sharing shall be done on a comparable basis for the market and non-market entities.
- c. The sharing is not related to projected Firm Flow Limits absent new DNRs or Transmission Service submitted on OASIS.
- d. The details of the process will include such items as which DNRs are covered, time-lines for designations and comparable evaluation of DNRs. If the details of this process can not be agreed upon, there shall be no sharing of the unused Allocations during the near-term.

A buffer will limit the amount of Allocation that can be shared for short-term requests during automated processing of the Allocation sharing process. The owner of the unused Allocation is not restricted by the buffer. The buffer is defined as a percentage of the last updated unused Allocation, provided that the buffer shall not be allowed to be less than a certain MW value. For example, a 25% or 20 MW buffer would mean that the requesting entity can use the other Reciprocal Entity's unused Allocation while making sure that the other entity's unused Allocation does not become smaller than 25% of the reported unused amount or 20 MW. The specific provisions of the buffer shall be mutually agreed to by the Reciprocal Entities prior to implementing a sharing of unused Allocation. The buffer will not be used in manual processing of Allocation

sharing requests. For manual processing of requests, the owner of the unused Allocation will share the remaining unused Allocation to the extent they do not need the unused Allocation for pending Transmission Service requests.

For the sharing of unused Allocations in the near-term, the Allocations are not changed and should congestion occur, the IDC obligations for the giving Reciprocal Entity will be in accordance with its original Allocation. The receiving Reciprocal Entity will not be required to retract or annul any service previously granted due to the sharing of Allocations.

6. Acquiring an Unused Allocation Beyond the Near Term

When a Reciprocal Entity does not have sufficient Allocation on a Flowgate to approve a firm point-to-point or network service request made on OASIS and evaluated via automated request evaluation tools and the other Reciprocal Entity has a remaining Allocation, the deficient Reciprocal Entity will be able to acquire an Allocation from the Reciprocal Entity with the remaining Allocation. This Allocation must not already be committed for other appropriate uses, as agreed to by the Reciprocal Entities, and sufficient AFC must remain on the Flowgate, or will be created, to accommodate the request. Such cases will be handled via automated processes.

Other firm uses of the transmission system involving generation to load deliveries, which are not evaluated via automated request evaluation tools, will be handled via off-line processes. The core principles to be applied in such cases include:

- a. A transfer of Allocation can occur.
- b. The transfer shall be done on a comparable basis for the market and non-market entities.
- c. The transfer is not related to projected Firm Flow Limit absent new DNRs or Firm Transmission Service submitted on OASIS.
- d. The details of the process will include such items as which DNRs are covered, time-lines for designations and comparable evaluation of DNRs. If the details of this process can not be agreed upon, there shall be no transfer of the Allocation for the time period beyond the near term.

A buffer will limit the amount of Allocation that can be acquired for these requests during automated processing of the Allocation transfer process. The owner of the unused Allocation is not restricted by the buffer. The buffer is defined as a percentage of the last updated unused Allocation, provided that the buffer shall not be allowed to be less than a certain MW value. For example, a 25% or 20 MW buffer would mean that the requesting entity can use the other Reciprocal Entity's unused Allocation while making sure that the other entity's unused Allocation does not become smaller than 25% of the reported unused amount or 20 MW. The specifics of the buffer shall be mutually agreed to by the Reciprocal Entities prior to implementing a transferring of unused Allocation. The buffer will not be used in manual processing of Allocation sharing requests. For manual processing of requests, the owner of the unused Allocation will

transfer the remaining unused Allocation to the extent they do not need the unused Allocation for pending Transmission Service requests.

The determination of whether the remaining Allocation has already been committed will be established based on OASIS queue time. All requests received prior to the queue time will be considered prior commitments to the remaining Allocation, while such requests are in a pending state (e.g. study status) or confirmed state. Requests received after the queue time will be ignored when determining whether remaining capacity has already been committed.

In the event that prior-queued requests are still in a pending state (i.e. not yet confirmed), the Reciprocal Entity requesting a transfer of unused Allocations may await the resolution of any prior-queued requests in the other Reciprocal Entity's OASIS queue before relinquishing its ability to request an Allocation transfer.

For the transfer of unused Allocations, the Reciprocal Entity's Allocations will be changed to reflect the Allocation transfer at the time the Allocation transfer request is processed. To the extent the request is not ultimately confirmed, the Allocation will revert back to the original Reciprocal Entity with the remaining Allocation. For yearly requests, the transfer of the Allocation applies to the original time period of the request including any roll-overs that are granted.

6.8 The Application of Firm Flow Limits in the IDC

In addition to the responsibilities described earlier in “Market-Based Operating Entity Congestion Management” Section 5 of this document, Market-Based Operating Entities will have an additional obligation, on Reciprocal Coordinated Flowgates, to further quantify their Non-Firm GTL flows into two (2) separate priorities in the IDC: Non-Firm Network (6-NN), and Non-Firm Hourly (2-NH). Within the IDC, the priorities will be determined as follows:

1. If the GTL flow exceeds the sum of the Firm Flow Limit and the 6-NN Allocation, then:
2-NH = GTL flow – (Firm Flow Limit + 6-NN Allocation)
6-NN = 6-NN Allocation
7-FN = Firm Flow Limit
2. If the GTL flow exceeds the Firm Flow Limit but is less than the 6-NN Allocation, then:
2-NH = 0
6-NN = GTL flow – Firm Flow Limit
7-FN = Firm Flow Limit
3. If the GTL flow does not exceed the Firm Flow Limit, then
2-NH = 0
6-NN = 0
7-FN = GTL flow
4. If the tag associated with EAR is converted to Market Flow and excluded by the IDC, the Market Flow shall have a priority that is no higher than it would have been if the tag was not excluded by IDC. This provision aims to keep the application of these tags consistent between the Market Flow used in market-to-market and the GTL calculation performed by the IDC and used in TLR.

All other aspects of this data remain identical to those described in “Market-Based Operating Entity Congestion Management” Section 5.

6.9 Real-time Operations Process for Market-Based Operating Entities

6.9.1 Market-Based Operating Entity Capabilities

Capabilities remain as described in “Market-Based Operating Entity Congestion Management” Section 5.

6.9.2 Market-Based Operating Entity Real-time Actions

Procedures remain as described in “Market-Based Operating Entity Congestion Management” Section 5. However, as described above, additional information regarding the firmness of those Non-Firm GTL flows will be communicated as well. A portion will be reported as 6-NN, while the remainder will be reported as 2-NH. This will provide additional ability for the IDC to curtail portions of the Non-Firm GTL flows earlier in the TLR process.

6.10 Requirements to Combine Allocations with Non-Reciprocal Entity

The following requirements must be satisfied for a Combining Party to incorporate a Non-Reciprocal Entity's load and the associated generation serving that load into the Reciprocal Entity's Allocation calculations:

1. The Non-Reciprocal Entity's load and associated generation serving that load participates in the market of the Combining Party pursuant to a FERC-accepted agreement(s).
2. The Non-Reciprocal Entity has not placed its transmission facilities under the Open Access Transmission Tariff of the Combining Party, nor has the Non-Reciprocal Entity executed a transmission owner agreement or membership agreement, or equivalent thereof, of the Combining Party.
3. The Non-Reciprocal Entity is wholly embedded (i.e., the load and associated generation serving that load are included in Allocations, Market Flows, and IDC GTL calculations) into the Combining Party's Control Area footprint in accordance with the CMP.
4. The Combining Party must treat the Non-Reciprocal Entity's impacts in the IDC, Market Flow, Firm Flow Limit, and Firm Flow Entitlement calculations consistently as the Combining Party does its own impacts in accordance with this CMP. The Non-Reciprocal Entity's load and associated generation serving that load otherwise needs to be eligible for inclusion in firm Allocations, Firm Flow Limit, and Firm Flow Entitlement under the terms of this CMP.
5. Any transmission facilities owned by the Non-Reciprocal Entity must be treated comparably to the transmission facilities of other Reciprocal Entities consistent with the terms of the CMP.
6. The Combining Party must provide notice to the other Reciprocal Entities of its plans to combine allocations within sixty (60) calendar days of making a filing at the FERC that would result in a Non-Reciprocal Entity's load and associated generation serving that load being combined with the Combining Party or upon combining Allocations (whichever occurs first). Even though a situation in which a Combining Party has proposed to combine Allocations with a Non-Reciprocal Entity may satisfy requirement numbers 1 through 5 of this list, this does not preclude other Reciprocal Entities from raising any objection pursuant to the dispute resolution process of a joint operating agreement or by filing a Section 206 complaint with the FERC if the proposed combination of Allocations would be inconsistent with this CMP or produces a result that is unjust and unreasonable.

Section 7 – Appendices

Appendix A – Glossary

Agreement – Agreement shall mean this Joint Operating Agreement Between the Midcontinent Independent System Operator, Inc. and PJM Interconnection, L.L.C., as amended from time to time, including all attachments, appendices, and schedules.

Allocation – A calculated share of capability on a Reciprocal Coordinated Flowgate to be used by Reciprocal Entities when coordinating AFC, transmission sales, and dispatch of generation resources.

Available Flowgate Capability (AFC) – the applicable rating of the applicable Flowgate less the projected loading across the applicable Flowgate less TRM and CBM. The firm AFC is calculated with only the appropriate Firm Transmission Service reservations (or interchange schedules) in the model, including recognition of all roll-over Transmission Service rights. Non-firm AFC is determined with appropriate firm and non-firm reservations (or interchange schedules) modeled.

AFC Flowgate – A Flowgate for which an entity calculates AFC's.

Combining Party – Combining Party shall mean a Reciprocal Entity that is incorporating the load and associated generation serving that load from a Non-Reciprocal Entity into the Reciprocal Entity's Allocations pursuant to Section 6.10 of this CMP.

Control Area – Shall mean an electric power system or combination of electric power systems to which a common automatic generation control scheme is applied.

Control Zones – Within an Operating Entity Control Area that is operating with a common economic dispatch, the Operating Entity footprint is divided into Control Zones to provide specific zonal regulation and operating reserve requirements in order to facilitate reliability and overall load balancing. The zones must be bounded by adequate telemetry to balance generation and load within the zone utilizing automatic generation control.

Coordinated Flowgate (CF) – shall mean a Flowgate impacted by an Operating Entity as determined by one of the five studies detailed in Section 3 of this document. For a Market-Based Operating Entity, these Flowgates will be subject to the requirements under the Congestion Management portion of this document (Sections 4 and 5). A Coordinated Flowgate may be under the operational control of a Third Party.

Designated Network Resource – A resource that has been identified as a designated network resource pursuant to a transmission provider's Open Access Transmission Tariff.

EIDSN – Eastern Interconnection Data Sharing Network.

External Asynchronous Resource¹ (EAR) – A Resource representing an asynchronous DC tie between the synchronous Eastern Interconnection grid and an asynchronous grid that is supported within the Transmission Provider Region through Dynamic Interchange Schedules in the Day-Ahead Energy and Operating Reserve Market and/or Real-Time Energy and Operating Reserve Market. External Asynchronous Resources are located where the asynchronous tie terminates in the synchronous Eastern Interconnection grid.

Firm Flow – The estimated impacts of Firm Transmission Service on a particular Coordinated or Reciprocal Coordinated Flowgate.

Firm Flow Limit – The maximum value of Firm Flows an entity can have on a Coordinated or Reciprocal Coordinated Flowgate, based on procedures defined in Sections 4 and 5 of this document.

Firm Market Flow – The portion of Market Flow on a Coordinated or Reciprocal Coordinated Flowgate related to contributions from the native load serving aspects of the dispatch (constrained as appropriate by the Firm Flow Limit).

Firm Transmission Service – The highest quality (priority) service offered to customers under a filed rate schedule that anticipates no planned interruption or similar quality service offered by transmission providers by contract that do not require the filing of a rate schedule. Firm Transmission Service only includes firm point-to-point service, network designated transmission service and grandfather agreements deemed firm by the transmission provider as posted on OASIS.

Flowgate – A representative modeling of facilities or groups of facilities that may act as significant constraint points on the regional system.

Freeze Date – the cutoff date chosen by Reciprocal Entities to be used in the calculation of Historic Firm Flows.

Generation-to-Load (GTL) – The calculated energy flows on a specified Flowgate as a result of dispatch of generating resources serving load within an Operating Entity’s Control Area, as specified in NAESB BPS WEQ-008 starting version 3.3.

Generator Priority Schedules (GPS) – A schedule that indicates the Transmission Service curtailment priority of the generator output, as specified in NAESB BPS WEQ-008-9.1.3.

Generator Shift Factor – A factor to be applied to a generator’s expected change in output to determine the amount of flow contribution that change in output will impose on an identified transmission facility or Flowgate, referenced to a swing bus.

¹ External Asynchronous Resource is specific to the MISO tariff, MISO, FERC Electric Tariff, Module A, § 1.E “External Asynchronous Resource” (33.0.0).

Historic Firm Flow – The estimated total impact an entity has on a Reciprocal Coordinated Flowgate when considering the impacts of (1) its historic Designated Network Resources serving native load, and (2) imports and exports, based on Firm Transmission Service reservations that meet the “Freeze Date” criteria.

Historic Firm Gen-to-Load Flow – The flow associated with the native load serving aspects of dispatch that would have occurred if all Control Areas maintained their current configuration and continued to serve their native load with their generation.

Historic Ratio – The ratio of Historic Firm Flow of one Reciprocal Entity compared to the Historic Firm Flow of all Reciprocal Entities on a specific Reciprocal Coordinated Flowgate.

LMP Based System or Market – An LMP based system or market utilizes a physical, flow-based pricing system to price internal energy purchases and sales.

Load Shift Factor – A factor to be applied to a load’s expected change in demand to determine the amount of flow contribution that change in demand will impose on an identified transmission facility or Flowgate, referenced to a swing bus.

Locational Marginal Pricing (LMP) – the processes related to the determination of the LMP, which is the market clearing price for energy at a given location in a Market-Based Operating Entity’s market area.

Market Flows – The calculated energy flows on a specified Flowgate as a result of dispatch of generating resources serving market load within a Market-Based Operating Entity’s market.

Market-Based Operating Entity – An Operating Entity that operates a security constrained, bid-based economic dispatch bounded by a clearly defined market area.

Network and Native Load (NNL) – the impact of generation resources serving internal system load, based on generation the network customer designates for Network Integration Transmission Service (NITS). NNL is also referred to as Gen to Load.

Non-Firm Market Flow – That portion of Market Flow related to a Market-Based Operating Entity’s market operations in excess of that entity’s Firm Market Flow.

Non-Reciprocal Entity – Non-Reciprocal Entity shall mean an Operating Entity that is not a Reciprocal Entity.

Operating Entity – An entity that operates and controls a portion of the bulk transmission system with the goal of ensuring reliable energy interchange between generators, loads, and other operating entities.

Party or Parties – Party or Parties refers to each party to this Agreement or both, as applicable.

Parallel Flow Visualization (PFV) – Conceptual ideas captured in NAESB BPS WEQ-008 starting with version 3.3.

Reciprocal Coordination Agreement – An agreement between Operating Entities to implement the reciprocal coordination procedures defined in the CMP.

Reciprocal Coordinated Flowgate (RCF) – A Flowgate that is subject to reciprocal coordination by Operating Entities, under either this Agreement (with respect to Parties only) or a Reciprocal Coordination Agreement between one or more Parties and one or more Third Party Operating Entities. An RCF is:

1. A CF that is (a) (i) within the operational control of Reciprocal Entity or (ii) may be subject to the supervision of Reciprocal Entity as Reliability Coordinator, and (b) affected by the transmission of energy by two or more Parties; or
2. A CF that is (a) affected by the transmission of energy by one or more Parties and one or more Third Party Operating Entities, and (b) expressly made subject to CMP reciprocal coordination procedures under a Reciprocal Coordination Agreement between or among such Parties and Third Party Operating Entities; or
3. A CF that is designated by agreement of both Parties as an RCF.

Reciprocal Entity – an entity that coordinates the future-looking management of Flowgate capacity in accordance with a Reciprocal Coordination Agreement as developed under Section 6 of this document, or a congestion management process approved by the Federal Energy Regulatory Commission; provided such congestion management process is identical or substantially similar to this CMP.

Security Constrained Economic Dispatch – the utilization of the least cost economic dispatch of generating and demand resources while recognizing and solving transmission constraints over a single Market-Based Operating Entity Market.

Tag Secondary Network Transmission Service Method (TSNT) - A method for determining the Transmission Service curtailment priority of the Secondary Network Transmission Service using e-Tags, as specified in NAESB BPS WEQ-008-1.9.2.

Third Party – Third Party refers to any entity other than a Party to this Agreement.

Tie Line – Tie Line shall mean a circuit connecting two Control Areas.

Transfer Distribution Factor – the portion of an interchange transaction, typically expressed in per unit, flowing across a Flowgate.

Transmission Service – services provided to the transmission customer by the transmission service provider to move energy from a point of receipt to a point of delivery.

Appendix B - Determination of Marginal Zone Participation Factors

In order for the IDC to properly account for tagged transactions into and out of the market area, a Market-Based Operating Entity using the Marginal Zone methodology will need to provide participation factors representing the facilities contributing to the tagged transactions. The facility or facilities contributing to each export tagged transaction is the source of the export tagged transaction. The facility or facilities contributing to each import tagged transaction is the sink of the import tagged transaction.

The Market-Based Operating Entity will be required to define a set of zones that can be aggregated into a common distribution factor that is representative of the market area. This information must be shared and coordinated with the IDC. Following this step, the Market-Based Operating Entity must then send to the IDC participation factors for those zones. These participation factors represent the percentages of how these zones are providing marginal megawatts as a result of dispatch of resources in market operations to serve transactions. Data sets for each external source/sink are required, which correspond to:

- An IMPORT data set, which indicates the participation of facilities accommodating the energy imported into the market area, and
- An EXPORT data set, which indicates the participation of facilities accommodating the energy exported out of the market area.

The methodology used by the Market-Based Operating Entity to determine the Marginal Zone participating factors will be determined through collaboration of the Market-Based Operating Entity with the IDC working group.

Participation Factor Calculation

The Market-Based Operating Entity will use the real-time system conditions to calculate the marginal zone participation factors, which reflect the impacts of tagged transactions. These will establish, for imports and exports, a set of participation factors that, when summed, will equal 100 percent.

Appendix C - Flowgate Determination Process

This section is has been added to clarify:

- How initial Flowgates are identified (Figure C-1, Table C-1)
 - Process for Flowgates in the Coordinated Flowgate list
 - Process for Flowgates in the Reciprocal Coordinated Flowgate list
 - Process for Flowgates in the AFC List
- How Flowgates will be added (Figure C-2, Table C-2)
- How often Flowgates are changed (Figure C-2, Table C-2)

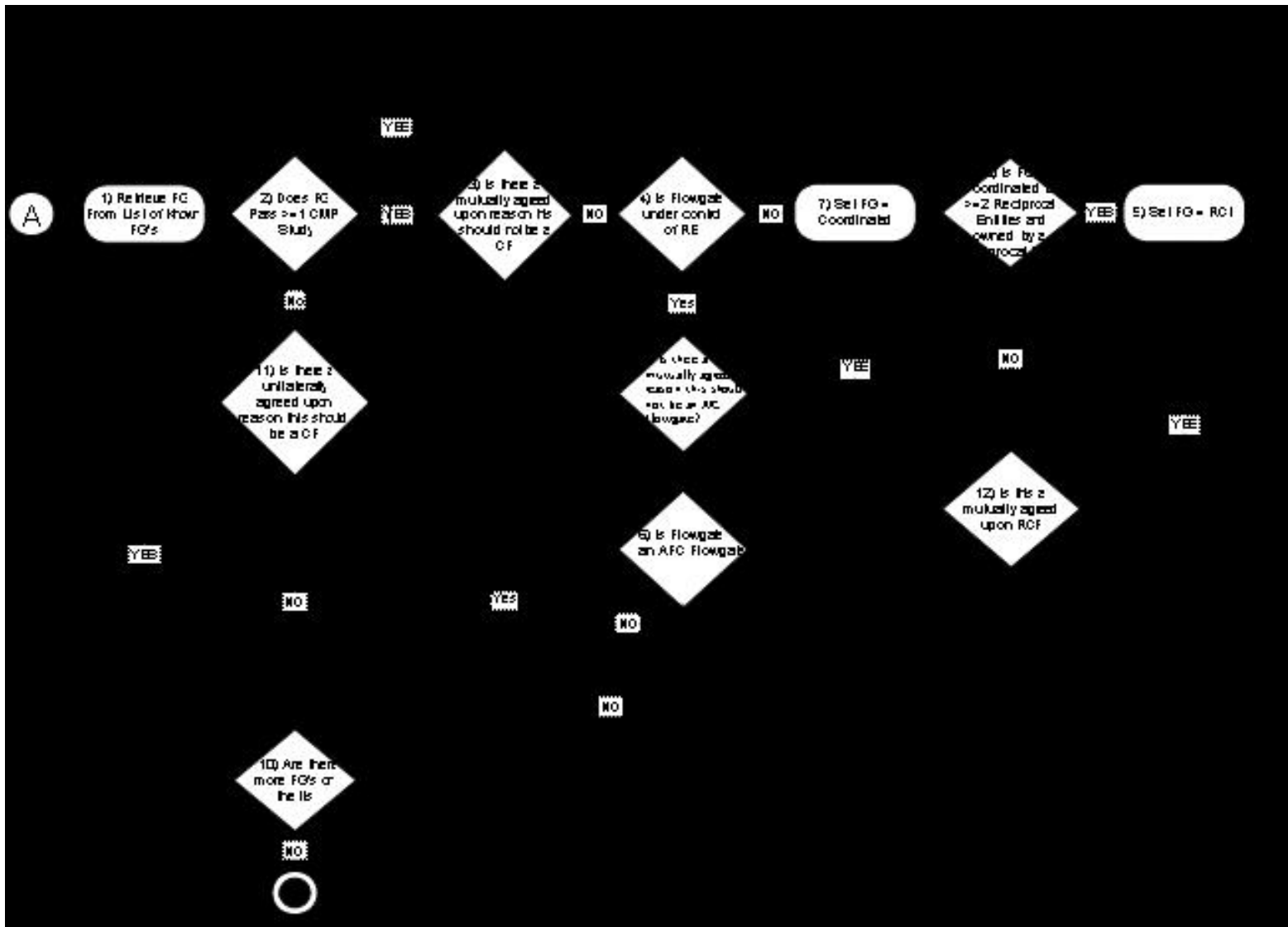

TABLE C-1				
Step	Activity	Requirements	Detailed Description	Additional Documentation
1	Retrieve FG From List Of Known FG's	Retrieve FG from AFC list of FGs, NERC Book of FGs, and any other list of FGs.	<ul style="list-style-type: none"> Retrieve the FG from the list of FGs. If a Reciprocal Entity wants us to consider a temporary FG it would go through the same process. 	See Impacted Flowgate Determination -Section 3
2	Determine if FG passes >= 1 CMP Study	The decision determines if the FG passes at least one of the five CMP studies.	<ul style="list-style-type: none"> If the FG passes any of the studies, determine if there is mutually agreed upon reason why this should not be a coordinated FG. 	
3	Is There a Mutually Agreed Upon Reason This Should Not Be A Coordinated Flowgate	Determine if there is a mutually agreed reason, despite passing one of the five tests, why this FG should not be considered Coordinated.	<ul style="list-style-type: none"> If the FG does not pass any of the studies, it will be determined if there is a unilaterally decided reason for inclusion as a CF. If there is no mutually agreed reason why this FG should not be considered coordinated, test whether FG is under control of a Reciprocal Entity. 	
4	Is the Flowgate under control of a Reciprocal Entity	If the Flowgate is under the control of a non-reciprocal entity and the Flowgate passes one of the five tests it will be treated as a Coordinated Flowgate.	<ul style="list-style-type: none"> If there is a mutually agreed reason why this FG should not be considered coordinated, record the reason proceed to Step 10. If the Flowgate is not under control of a Reciprocal Entity proceed to Step 7. 	
5	Is there a mutually agreed reason this should not be AFC Flowgate?	Determine if there is a mutually agreed reason, despite qualifying as a Coordinated Flowgate, why this Coordinated Flowgate is not included in the AFC process.	<ul style="list-style-type: none"> If the Flowgate is under control of a Reciprocal Entity Proceed to Step 5. If there is a mutually agreed reason to not include the Coordinated Flowgate in the AFC process proceed to Step 7. Otherwise proceed to Step 6. 	

Step	Activity	Requirements	Detailed Description	Additional Documentation
6	Is Flowgate an AFC Flowgate	A check is done to determine if the Flowgate controlled by a Reciprocal Entity is in its AFC process.	<ul style="list-style-type: none"> • If the Flowgate is in the AFC process or in the process of being added to the AFC process proceed to Step 7. • Otherwise proceed to Step 10 	
7	Set FG = Coordinated	The FG would be coordinated for the entity.	<ul style="list-style-type: none"> • The FG would be considered a CF. 	

Step	Activity	Requirements	Detailed Description	Additional Documentation
8	Is FG Coordinated for >= 2 Reciprocal Entities and “owned” by a Reciprocal Entity	Determine whether the FG is coordinated for two or more Reciprocal Entities	<ul style="list-style-type: none"> • If the FG is coordinated for two or more Reciprocal Entities and it is “owned” by one of the entities, it will be added to the CMP process as a reciprocal coordinated FG. 	CM Process -Section 6
			<ul style="list-style-type: none"> • If it is not coordinated for two or more Reciprocal Entities and “owned” by one of the entities, determine if it is a mutually agreed upon RCF. 	
9	Set FG = RCF	Set the Flowgate equal to a Reciprocal Coordinated Flowgate.	<ul style="list-style-type: none"> • Set the Flowgate equal to a Reciprocal Coordinated Flowgate. • Proceed to Step 10. 	
10	Are there more FGs on the list?	Determine if there are any more FGs on the list that need to go through the CMP determination process.	<ul style="list-style-type: none"> • If there are no more FGs that need to go through the determination process, the process ends. • If there are more FGs that need to go through the determination process, retrieve the next one. 	
			<ul style="list-style-type: none"> • Proceed to Step 1 if another FG requires evaluation. • Otherwise, the process ends. 	
11	Is There a Unilateral Decision This Should Be A Coordinated FG	This decision determines if an entity wants to make this a Coordinated FG for a reason other than the five tests.	<ul style="list-style-type: none"> • If an entity decides to make this a coordinated FG, proceed to Step 4. • Otherwise, proceed to Step 10. 	
12	Is This a Mutually Agreed Upon RCF	Determine if there is a mutually agreed reason this should be considered a Reciprocal Coordinated Flowgate.	<ul style="list-style-type: none"> • If there is no mutually agreed reason this should be considered an RCF, leave it as coordinated and check for more FGs. • If there is a mutually agreed reason this should be considered an RCF, mark it as such. • If Reciprocal Entities decide to make the Flowgate Reciprocal proceed to Step 9. • Otherwise, proceed to Step 10. 	

Figure C-2
Flowgate Review and Customer
Flowgate Request

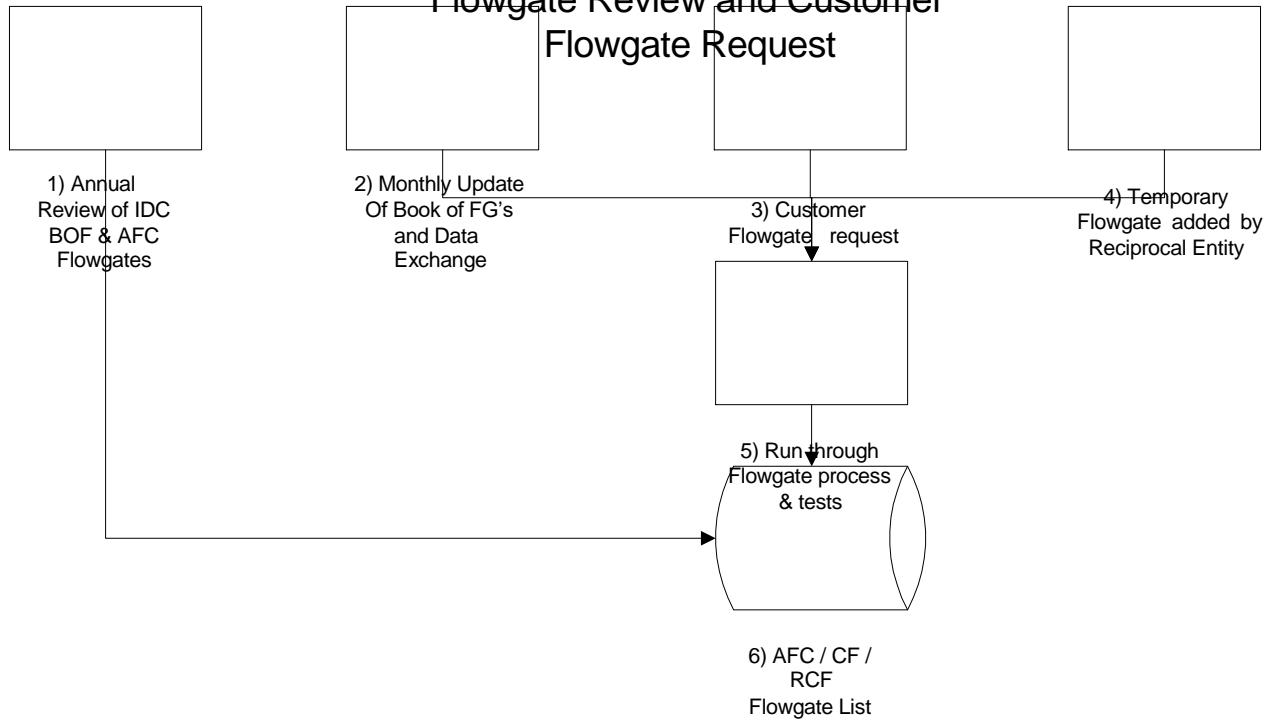

TABLE C-2				
Steps	Activity	Requirements	Detailed Description	Additional Documentation
1	Annual Review of the BOFs and AFC FGs	A review will be performed annually or more often as requested by Reciprocal Entities (CMPWG). Retrieve the FG from the list of FGs for the entity running the	<ul style="list-style-type: none"> Except for Study 1 in section 3.2.1 of the CMP, the FGs will be run through the process summarized in figure C-1. 	
		process. Study 1 in section 3.2.1 of the CMP is not required for this annual review.		
2	Customer FG Requests	Any customer FG requests will also be subject to the tests and process above.	<ul style="list-style-type: none"> Any customer FG requests will be run through the process summarized in figure C-1. 	
3	Temporary Flowgate added by Reciprocal Entity	Any temporary Flowgate added by a Reciprocal Entity will also be subject to the tests and processes	<ul style="list-style-type: none"> Any temporary Flowgates added by a Reciprocal Entity will be run through the process summarized in figure C-1 	
4	Run Through FG Process and Tests	Run through FG Determination Process, figure C-1	<ul style="list-style-type: none"> Any FGs being reviewed or added will be run through the process summarized in figure C-1. 	
5	AFC/CF/RCF List	Any FG additions or modifications would need to be committed to the repository of FGs and their qualifications.	<ul style="list-style-type: none"> Any FG additions or modifications would need to be committed to the repository of FGs, along with their qualifications. 	

Appendix D – Training

The concepts in these proposals should not have a significant impact upon system operators beyond the operators of the Operating Entity. The reason that this impact rests upon the Operating Entities is that the Operating Entities Operators will need to be trained to monitor and respond to the external Flowgates.

Reliability Coordinator (RC) Operator Training Impacts include:

1. The ability to recognize and respond to Coordinated Flowgates.
 - a. IDC outputs will show schedule curtailments and possible redispatch requirements.
 - b. Must be able to enter constraint in systems to provide the redispatch relief within 15 minutes.
 - c. Must be able to confirm that the required redispatch relief has been provided and data provided to the IDC.
2. Capability to enter Flowgates on the fly.

Other RC System Operators Training Impacts include:

1. The ability to take projected net system flows between an Operating Entity's Control Zones versus only tag data to run day-ahead analysis (data to be provided by the IDC).
2. Need to develop a working knowledge of how relief on a TLR Flowgate can come from both schedule changes and redispatch on a select set of Coordinated Flowgates.
3. Can coordinate with another RC Operator when the RC System Operator has a temporary Flowgate that they believe requires the implementation of the “Flowgate on the Fly” process.

Appendix E –Reserved

Appendix F – FERC Dispute Resolution

RCF Dispute Resolution

If a Party has followed all processes in the disputed Flowgate process outlined in section 3.2 and is dissatisfied with the ORS resolution of the Flowgate dispute, the Party may refer the dispute to FERC’s Dispute Resolution Service for mediation, and upon a Party’s determination at any point in the mediation that mediation has failed to resolve the dispute, either Party may seek formal resolution by initiating a proceeding before FERC.

Allocation Adjustment for New Transmission Dispute Resolution

If a Party has followed all processes in the Allocation Adjustment Peer Review process outlined in Appendix G and is dissatisfied with the resolution of the CMPC, the Party may refer the dispute to FERC’s Dispute Resolution Service for mediation, and upon a Party’s determination at any point in the mediation that mediation has failed to resolve the dispute, either Party may seek formal resolution by initiating a proceeding before FERC.

Appendix G – Allocation Adjustment for New Transmission Facilities and/or Designated Network Resources

MISO and PJM utilize the same Guiding Principles as other Reciprocal Entities for Allocation Adjustment for New Transmission Facilities and/or Designated Network Resources. In addition MISO and PJM have established procedures for allocation adjustments based on cross-border cost sharing and for determining the builder for the new transmission service or upgrades. These procedures also apply to facility upgrades that have been funded in whole or in part for the purpose of obtaining Incremental ARR under one Party's tariff by a market participant in one or both markets.

1. Guiding Principles

The following guiding principles will be used in determining the allocation adjustments for New Transmission Facilities and/or Designated Network Resources.

- Principle 1 (Non-builder held harmless) – To the extent possible, the non-building entity will receive the same overall impacts in its allocations.
- Principle 2 (Builder receives benefits) – To the extent possible, the building entity will receive any benefit to the transmission system that result from the system upgrade.

To the extent these two principles conflict, the Non-Builder Held Harmless Principle will have priority over the Builder Receives Benefit Principle.

2. New Transmission Facilities That Do Not Involve New DNR or New Firm Transmission Service

To the extent a new transmission facility causes a significant decrease in flow on a Reciprocal Coordinated Flowgate, the change in the allocation will be assigned to the Reciprocal Entity with functional control of the new transmission facility. Otherwise, the normal allocation procedures will be followed and no allocation adjustments for new transmission facilities will be made.

Significant impact is defined as a 3% change in flow that occurs to an OTDF Flowgate and a 5% change in flow that occurs to a PTDF Flowgate with the addition of the new facility. The 3% and 5% are measured as a percentage of the Flowgate TTC (sometimes called Total Flowgate Capability (TFC)).

The allocation adjustment will be assigned to the Reciprocal Entity with functional control of the new transmission facility. Both the original allocation and the allocation adjustment are assigned to the Reciprocal Entities. To the extent a group of transmission owners installs a new facility that includes multiple Reciprocal Entities and the new transmission facility results in a change in transfer capability on one or more RCFs, these Reciprocal Entities will work in collaboration to determine appropriate adjustments to each Reciprocal Entity's allocation on all significantly impacted RCFs.

An analysis will be performed both with and without the new facility to determine whether there is a significant impact on one or more RCFs. The analysis and any subsequent allocation adjustments will coincide with the expected in-service date of the new facility. The inclusion of the new transmission facility in such an analysis is dependent on having a commitment that the

new facility has or is expected to receive all of the appropriate approvals and will be installed on the date indicated.

In order to qualify for an allocation adjustment, the new transmission facility must not only create a significant change in flows, it must also be a significant change to the transmission system (i.e. a new line or transformer that creates a significant change to flows on one or more RCFs). The addition of a new generator without transmission additions (other than the generation interconnection) is not covered by this process for new transmission facility additions. A change in the rating of an RCF may qualify as a significant change to the transmission system and be eligible to receive an allocation adjustment even though it does not result in a change in flows.

For stability limited Flowgates, a new generator, reactive device or change to a remedial action scheme may contribute to a change in the transfer limitation of stability limited Flowgates. Where this occurs and the addition is being made for the specific purpose of changing the transfer limitation of stability limited Flowgates, an allocation adjustment will be provided to the Reciprocal Entity responsible for the new generator, reactive device or change to a remedial action scheme. By receiving an allocation adjustment, this new generator, reactive device or change to a remedial action scheme will not also be included in the historical usage calculation to avoid double-counting of the impacts.

Not all new transmission facilities that significantly impact RCFs involve a change in flows. A new facility may be added that changes the rating of an RCF but has minimal impact on the flow (i.e. reconductoring, replacing a wave trap (WT) or current transformer (CT), replacing a transformer). In this case, each Reciprocal Entity's historical usage flow will remain constant but the rating of the Flowgate will either increase or decrease. The Reciprocal Entity responsible for the new facility will receive an allocation adjustment for rating increases. There will be no allocation adjustments for rating decreases.

There is an equity issue involving new transmission facilities that result in an increased rating. Where a new facility involves minimal cost change (such as replacing either a WT or CT, replacing a jumper, replacing a switch, changing a CT setting, etc.), there have already been significant costs incurred on a larger conductor that allows the increased rating to occur. As long as the Reciprocal Entity making the minimal cost change is also responsible for the conductor, it is the appropriate Reciprocal Entity to receive the allocation adjustment. However, if different Reciprocal Entities own the conductor versus are responsible for making the minimal cost change, there is an equity issue if the entire allocation adjustment is given to the Reciprocal Entity responsible for making the minimal cost change. The Reciprocal Entities shall negotiate a mechanism to share in the allocation adjustment.

3. New Transmission Facilities that Involve New DNR or New Firm Transmission Service

Where a new transmission facility is added as part of an approved new usage of the transmission system (either a new DNR or a new Firm Transmission Service), the Reciprocal Entity responsible for the new facility has two choices on the treatment of this combination. First, in recognition that they have addressed transmission concerns associated with the new DNR or new Firm Transmission Service, the combination of the new transmission facility and new DNR/Firm Transmission Service will be added to the base model used in the historic usage impact

calculation. The new DNR or new Firm Transmission Service will be treated as if it met the Freeze Date. To the extent the new transmission facility and its associated new DNR or new Firm Transmission Service will not occur until a future time period, they will not appear in the historic usage impact calculation until after the in-service/start date. The inclusion of the new transmission facility and associated DNR/Firm Transmission Service is dependent on having a commitment that both have been approved and will occur on the date indicated. If no such commitment exists, these additions will not be included in the historic usage impact calculation. By making this choice to include the new transmission facility and DNR/Firm Transmission Service in the historic usage impact calculation, the NNL allocation will consider the impact of both. This may result in increased NNL allocation to all Reciprocal Entities after considering historic usage impacts (down to 0%). However, the Reciprocal Entity that builds the new transmission facility will not receive any special treatment (NNL allocation adjustment) because of the new transmission facility. This inclusion of a new DNR or new Firm Transmission Service only applies where associated new transmission facilities have been added to accommodate the new transmission usage.

Second, the Reciprocal Entity that builds the new transmission facility associated with a new DNR or new Firm Transmission Service can receive an NNL allocation adjustment and must honor that allocation when they apply the new DNR or new Firm Transmission Service in their use of NNL allocations. The Reciprocal Entity determines the impact of the new transmission facility without the new DNR or new Firm Transmission Service to calculate any adjustments to the NNL allocations (the same process documented in the previous section “New Transmission Facilities that Do Not Involve New DNRs or New Firm Transmission Service). The Reciprocal Entity will use the remaining NNL allocation that has not been committed to other uses for the new DNRs or new Firm Transmission Service.

The Reciprocal Entity responsible for the combination of new transmission facility and new DNR/Firm Transmission Service will make a single choice (either one or two) that applies to all RCFs that are significantly impacted by the combination. There is no opportunity to have a different selection on different RCFs that are all impacted by the same combination.

4. Allocation Adjustment Peer Review

When reviewing the allocation adjustments, if an impacted Reciprocal Entity finds a situation where the rule set does not produce a satisfactory outcome, the impacted Reciprocal Entity may request a review by the CMPWG. The impacted Reciprocal Entity will present the unsatisfactory results and a proposed alternative. If the CMPWG agrees to the proposed alternative it will be implemented as an exception, and the CMPC will be notified of the exception prior to implementation. If the CMPWG does not agree, the impacted Reciprocal Entity can seek further review by the CMPC. The impacted Reciprocal Entity will present its proposed alternative and the CMPWG member(s) will present their concerns to the CMPC for the CMPC to take action. All exceptions approved by the CMPWG or CMPC will be documented for future reference.

Depending on the nature of the upgrade, the impact of the new facility will be held in abeyance pending completion of the review. This means for a rating change, the prior rating will continue to be used in the model update process pending completion of the review. This means for a flow change, the new facility will be recognized in the model update process. The impacts will be

calculated using the normal (socialized) allocation process and no allocation adjustments will be made pending completion of the review. These reviews should be completed in a timely manner.

5. Allocation Adjustments Based on Cross-Border Cost Sharing

The physical rights to any significantly impacted incremental capacity on existing RCFs, that is a result of the cross-border allocation process (“allocation adjustment”), will be assigned to a Party, for congestion management purposes, in proportion to the share of the costs that such Party must pay under the cost allocation process in Section 9.4.4.2 of the JOA.

An allocation adjustment based on the share of costs that such Party must pay under the cost allocation process in Section 9.4.4.2 of the JOA will apply only where there has been a significant decrease in flows on an existing RCF.

An analysis will be performed both with and without the new facility to determine whether there is a significant impact on one or more RCFs. The analysis and any subsequent allocation adjustments will coincide with the expected in-service date of the new facility. The inclusion of the new transmission facility in such an analysis will be dependent upon having a commitment that the new facility has or is expected to receive all of the appropriate approvals and will be installed on the date indicated.

6. Determination of Builder in the Flowgate Allocation Process

For MISO and PJM, flowgate allocations are used to sell firm transmission service and to prioritize market flows reported to the IDC that are then subject to curtailment during TLR. At the same time, flowgate allocations are also used in the market-to-market settlement process and in the ARR, FTR, and day-ahead market loop flow modeling between MISO and PJM. The firm flow entitlement used in market-to-market settlement and in the ARR, FTR, and day-ahead market loop flow modeling is derived from a combination of flowgate allocations in the forward direction and market flow impacts in the reverse direction. This allocation agreement between MISO and PJM is limited to how to assign allocations and does not extend into ARRs, FTRs, and day-ahead market loop flow assumptions.

In order to implement the allocation process, MISO and PJM have defined the terms builder and non-builder as follows when applying the allocation adjustment rules:

- The term builder refers to a Party that has responsibility (either total or partial) for construction of the transmission facility upgrade and is entitled to receive the increase in capacity of existing flowgates while holding the non-builders harmless. Where a market participant in one or both markets has funded some or all of a transmission facility upgrade for the purpose of obtaining Incremental ARRs under one Party’s tariff, the term builder refers to the Party providing Incremental ARRs.
- In determining which Party has total or partial responsibility for construction of the transmission facility upgrade, responsibility is defined as the Party that has cost responsibility for the upgrades. The cost responsibility could be to a single Transmission Owner pricing zone within a market footprint, to multiple Transmission Owner pricing zones within the same market footprint, to multiple Transmission Owner pricing zones

within both market footprints as in the case of a cross-border project funded by the two markets, or to a single market participant as in the case of a transmission upgrade funded by a market participant.

- Where the responsibility for cost is to either a single Transmission Owner pricing zone or to multiple Transmission Owner pricing zones within the same market footprint in which the upgrade is built, the total allocation goes to the builder after holding the non-builder harmless.
- Where the responsibility for cost is shared by multiple Transmission Owner pricing zones within both market footprints, the allocation will be split between the Parties in proportion to the cost responsibility between the Parties.
- Where the responsibility for cost is to a single market participant funder (rather than to an entire pricing zone) that has resources/participates in one market only, the allocation goes to that market, irrespective of the Party that owns the flowgate and in which the upgrade resides.
- Where the responsibility for cost is to a market participant funder that has resources/participates in both markets, the allocation will be split between the two markets subject to the Parties' OATT and business practices.

Appendix H – Application of Market Flow Threshold Field Test Conditions

MISO, PJM and SPP participated in a NERC approved Market Flow threshold field test from June 1, 2007 to October 31, 2009. The purpose of the field test was to determine a Market Flow threshold percentage that allows the three Regional Transmission Organizations (RTOs) to consistently meet their relief obligation during TLR without jeopardizing reliability. Although the field test was able to achieve a success rate close to 100% based on MISO data using a 5% threshold, the following conditions were applied to the field test results:

- Market Flows were evaluated 30 minutes after implementation of the TLR curtailment.
- A 5 MW dead-band (or 10% of the relief obligation for relief obligations greater than 50 MW) was applied to the Target Market Flow such that once actual Market Flows were within the dead-band, it was considered a success meeting the relief obligation.
- There were no instances where MISO was able to meet its relief obligation if more than 30 MW must be removed within 30 minutes. The field test found the amount of Market Flow that must be removed in 30 minutes and not the size of the relief obligation is an indicator whether the market will be successful.

Since the NERC ORS applied the three conditions above to the field test results in order to demonstrate a high success rate, these same conditions will be applied when the Market-Based Operating Entities have relief obligations on external Flowgates during TLR.

The field test results are only applicable to Flowgates that are external to each of the RTOs and does not include internal Flowgates (internal to that specific RTO) or market-to-market Flowgates (internal to one of the three RTOs but subject to market-to-market provisions with another RTO). The reason for excluding internal Flowgates and market-to-market Flowgates is because the three RTOs use market redispatch to control total flow and to maintain reliability. As the Reliability Coordinator for the Flowgate, the three RTOs are responsible for the reliability of their own Flowgate and must manage total flow in order to meet their reliability responsibility. As described in the field test final report, by controlling total flow, the three markets effectively meet their relief obligation.

MISO

Second Revised Rate Schedule FERC No. 5

PJM Interconnection, L.L.C.

Second Revised Rate Schedule FERC No. 38

ATTACHMENT 3

Interregional Coordination Process

Version 3.0

**MISO & PJM Market-to-Market
Interregional Coordination Process
Table of Contents**

Preface

1	Overview of the Market-to-Market Coordination Process
2	Interface Bus Price Coordination
3	Real-Time Energy Market Coordination
3.1	Real-Time Energy Market Coordination Procedures
3.2	Real-Time Energy Market Settlements
4	Day-Ahead Energy Market Coordination
4.1	Day-Ahead Energy Market Coordination Procedures
4.2	Day-Ahead Energy Market Settlements
5	Auction Revenue Rights Allocation/Financial Transmission Rights Auction Coordination
6	Coordination Example
7	When One of the RTOs Does Not Have Sufficient Redispatch
8	Appropriate Use of Market-to-Market Process
9	Overview of Coordinated Transaction Scheduling
10	Market-to-Market Settlement Calculations for the Michigan-Ontario Phase Angle Regulators Interface
11	Market Flow Adjustment for Generator Pseudo-Ties

Appendix A: Definitions

Preface

The purpose of this Interregional Coordination Process (“ICP”) is to provide a description of the proposed market-to-market coordination process, including the appropriate use of the market-to-market process, that will be implemented concurrently with the implementation of side-by-side LMP-based energy markets in the PJM and MISO regions. Specifically, this ICP presents an overview of the market-to-market coordination process, an explanation of the coordination for market pricing at the regional boundaries, a description of the Real-Time and Day-Ahead coordination methodologies, an example to illustrate the Real-Time coordination, and the associated settlements processes.

1 Overview of the Market-to-Market Coordination Process

The fundamental philosophy of the PJM/MISO interregional transmission congestion coordination process is to set up procedures to allow any transmission constraints that are significantly impacted by generation dispatch changes in both markets to be jointly managed in the security-constrained economic dispatch models of both RTOs. This joint management of transmission constraints near the market borders will provide the more efficient and lower cost transmission congestion management solution, while providing coordinated pricing at the market boundaries.

The market-to-market coordination process builds upon the PJM/MISO market-to-non-market coordination process, as described in the “Congestion Management Process” document (“CMP”) filed as part of the MISO – PJM Joint Operating Agreement. That CMP describes the interregional coordination process between a market region that uses an LMP-based congestion management regime and a non-market region that uses a TLR-based congestion management regime (i.e., a market to non-market interface). As described in the CMP, the set of transmission flowgates in each market that can be significantly impacted by the economic dispatch of generation serving load in the adjacent market is identified as the set of Reciprocal Coordinated Flowgates (RCFs). These RCFs are then monitored to measure the impact of Market Flows and loop flows from adjacent regions. The CMP describes how the Market Flow impacts will be managed on an interregional basis within the existing NERC IDC to enhance the effectiveness of the NERC interregional congestion management process. The CMP also describes a process for calculating flow entitlement for network and firm transmission utilization in one region on the RCFs in an adjacent region.

The market-to-market coordination process builds on the work already completed, as described above, by adapting the coordination, as appropriate, to the conditions that will prevail after both the PJM and MISO markets are implemented in the Midwest. In addition, there is a continuing need to define the flow entitlement for network and firm transmission utilization in one region on the subset of RCFs called M2M Flowgates in an adjacent region.

- **Real-Time Energy Market Coordination** -- The market-to-market coordination focuses primarily on Real-Time market coordination to manage transmission limitations that occur on the M2M Flowgates in a more cost effective manner. This Real-Time coordination will result in a more efficient economic dispatch solution across both markets to manage the Real-Time transmission constraints that impact both markets, focusing on the actual flows in Real-Time to manage constraints. Under this approach, the flow entitlements on the M2M Flowgates do not impact the physical dispatch; the flow entitlements are used in market settlements to ensure appropriate compensation based on comparison of the actual Market Flows to the flow entitlements.
- **Day-Ahead Energy Market Coordination** -- The Day-Ahead market coordination focuses primarily on ensuring that the Day-Ahead scheduled flows on all M2M Flowgates are limited to no more than the Firm Flow entitlements for each RTO. Under certain conditions set forth in this Agreement, an RTO may request that the Day-Ahead flow limit be raised above its Firm Flow entitlement.

- **ARR Allocation & FTR Auction Coordination** -- The Auction Revenue Rights Allocation and Financial Transmission Rights (FTR) auction processes in both RTOs will model the Firm Flow entitlements on all M2M Flowgates.

1.1 Only a subset of all transmission constraints that exist in either market will require coordinated congestion management. This subset of transmission constraints will be identified as M2M Flowgates in a manner similar to the method used in the CMP described above. The list of M2M Flowgates will be limited to only those for which at least one generator in the adjacent market has a significant Generation-to-Load Distribution Factor (GLDF), sometimes called “shift factor,” with respect to serving load in that adjacent market. NERC rules currently establish that a significant shift factor is five percent or greater. If NERC adopts a lower shift factor threshold than 5%, the new threshold will be used to determine whether the generator has a significant GLDF for the purpose of this market-to-market ICP. Flowgates eligible for market-to-market coordination are called M2M Flowgates. For the purposes of market-to-market coordination (in addition to the five studies for RCFs described in section 3.2.1 of the CMP) the following will be used in determining M2M Flowgates.

- 1.1.1 M2M Flowgates include Reciprocal Coordinated Flowgates and any additional Flowgates that meet the criteria in this section (1.1) of the Interregional Coordination Process.
- 1.1.2 MISO and PJM will only be performing market-to-market coordination on RCFs that are under the operational control of MISO or PJM. MISO and PJM will not be performing market-to-market coordination on Flowgates that are owned and controlled by third party entities or on Flowgates that are only considered to be coordinated Flowgates.
- 1.1.3 Where the adjacent market does not have a generator with significant impact (either positive impact or negative impact) on a single-monitored element Flowgate at voltages higher than 138 kV (i.e., shift factor is less than 5%) but its Market Flows are a significant portion of the total flow (greater than 25% of the Flowgate rating), these transmission constraints will be included in the list of M2M Flowgates subject to market-to-market coordination. If the Market Flow impacts of the Non-Monitoring RTO exceed 25% of the Flowgate rating during real-time operations, the Flowgate will be added as a M2M Flowgate at the request of the Monitoring RTO.

Where the adjacent market does not have a generator with significant impact (either positive impact or negative impact) on a single-monitored element Flowgate at voltages of 138 kV or lower (i.e., shift factor is less than 5%) but its Market Flows are a significant portion of the total flow (i.e., greater than 35% of the Flowgate rating), these transmission constraints will be included in the list of M2M Flowgates subject to market-to-market coordination. If the Market Flow impacts of the Non-Monitoring RTO exceed 35% of the Flowgate rating during real-time operations, the Flowgate will be added as a M2M Flowgate at the request of the Monitoring RTO.

- 1.1.4 The Parties will lower their generator binding threshold to match the lower generator binding threshold utilized by the other Party. The generator binding threshold will not be set below 1.5% except by mutual consent. (This requirement applies to M2M Flowgates. It is not an additional criteria for determination of M2M Flowgates.)
- 1.1.5 For the purpose of determining whether a multi-monitored element Flowgate is eligible for market-to-market, a progressive threshold based on the number of monitored elements will be used: a single monitored element Flowgate will use a 5% shift factor threshold; double monitored element Flowgate will use a 7.5% shift factor threshold; and a Flowgate with three monitored elements will use a 10% shift factor threshold. Flowgates with more than three monitored elements will be used only by mutual agreement.
- 1.1.6 The five studies for RCFs described in Section 3.2.1 of the CMP will also be performed using a -5% shift factor threshold to identify Flowgates with a significant negative impact due to market operations. Flowgates where a significant negative impact exists as measured by a -5% shift factor or more negative shift factor will be added as M2M Flowgates.

1.2 M2M Flowgate Studies

During the M2M Flowgate Studies, a M2M Flowgate may be added to the systems for operations control using the actual monitored /contingent element pair. Settlements will be implemented using a hold harmless approach as described in the After the Fact Review process set forth in Section 8.4 below.

- 1.2.1 MISO and PJM will implement a process whereby either RTO may request the other to enter an anticipated M2M Flowgate into the dispatch tools before the completion of the Flowgate studies when a system event requires prompt attention. Binding on the Flowgate may commence as soon as each entity's operators can make the monitored/contingent element pair available in its system. Firm Flow Entitlements shall be applied and settlements calculated after the M2M Flowgate is approved by both entities.
- 1.2.2 Use of a M2M Flowgate Before Completion of the Studies:
The use of an anticipated Flowgate while the Flowgate is undergoing the M2M Flowgate Studies is described in CMP Section 3.2.5 Dynamic Creation of Coordinated Flowgates. These will typically be limited to forced outages since there should be time to evaluate the potential new M2M Flowgate before the planned outage is taken. However, the need for a new Flowgate is not always identified in advance. The Parties will ensure the time period to run the coordinated Flowgate test and have these Flowgates ready for the market-to-market process is as short as possible.

1.3 Removal of M2M Flowgates

Removal of M2M Flowgates from the systems may be necessary under certain conditions including the following:

- 1.3.1 Where Information Technology systems cannot support the operation of a defined M2M Flowgate effectively, the first attempt will be to find a mutually acceptable temporary work-around that will allow the continued use of the market-to-market process. Where a temporary work-around is not available, the market-to-market process will be suspended on that M2M Flowgate until Information Technology system enhancements allow re-establishing the M2M Flowgate. The Party responsible for IT system enhancements will take all practicable steps to minimize the period of the suspension.
- 1.3.2 A M2M Flowgate is no longer valid when either a temporary M2M Flowgate or a transmission system change is implemented that eliminates significant impacts from either entity's generation such that the Flowgate no longer passes the M2M Flowgate Studies.
 - a. Once a M2M Flowgate becomes a completely invalid constraint, it will no longer be bound in the monitoring RTO's UDS.
 - b. A Flowgate that is removed from the M2M Flowgate list but remains a valid constraint may continue to be bound in the Monitoring RTO's UDS, but the market-to-market process will no longer be initiated on it.
- 1.3.3 The RTOs will collaborate to address specific scenarios where generation is not responding to dispatch signals (e.g., self scheduled) and the generation does, or could, significantly impact an M2M Flowgate and/or resulting market-to-market settlement.
- 1.3.4 The Parties can mutually agree to add or remove a Flowgate from the market-to-market process whether or not it passes the coordination tests, or whether or not it is a Reciprocal Coordinated Flowgate. A M2M Flowgate may be removed when the Parties agree that the market-to-market process would not be an effective mechanism to manage congestion on that Flowgate.

2 Interface Bus Price Coordination

Proxy bus prices are calculated by each RTO to reflect the economic value of imports or exports from the neighboring RTO. For example, the proxy bus price for RTO A as calculated by RTO B is driven by the economic dispatch of RTO B, therefore this proxy price will reflect the system marginal price in RTO B, plus any congestion cost adjustment and marginal loss cost adjustment based on the proxy bus location. The coordinated operation of M2M Flowgates will tend to force the pricing at the RTO borders to be consistent with the energy prices at generators and load busses near the RTO border points.

In order to be good functional indicators for the market-to-market coordination, the proxy bus models for PJM and MISO must be coordinated to the same level of granularity. Therefore, the proxy bus modeling approaches must be similar such that the prices are consistent. This does not necessarily mean the proxy bus prices will be the same, particularly in the initial implementation of Market-to-Market coordination. What is important at the outset is that the proxy buses reflect consistent pricing between the RTOs given the constraints for which each RTO is operating. Consistency means that the proxy bus price one RTO calculates for the other RTO reflects the nature of the congestion on both RTOs' systems, such that imports and exports to and from one RTO to the other are provided the correct incentives given their effect on the current binding constraints. A description of the current proxy bus modeling process used by PJM and MISO is posted on each RTO's OASIS.

As the Market-to-Market coordination process continues to evolve, it may be possible to get to the point that each RTO's proxy bus prices for the other is consistently close. This will require coordination beyond merely operating for constraints on each other's systems, to include tightly coordinating the economic dispatches themselves, in an iterative process as described in Section 7.

3 Real-Time Energy Market Coordination

When an M2M Flowgate that is under the operational control of either MISO or PJM become binding in the Monitoring RTOs Real-Time security constrained economic dispatch, the Monitoring RTO will notify the Non-Monitoring RTO of the transmission constraint violation and will identify the appropriate M2M Flowgate that requires mitigation. The Monitoring and Non-Monitoring RTOs will provide the economic value of the constraint (i.e., the shadow price) as calculated by their respective dispatch models. Using this information, the security-constrained economic dispatch of the Non-Monitoring RTO will include the transmission constraint; the Monitoring RTO will evaluate the shadow prices within each RTO and request that the Non-Monitoring RTO reduce its Market Flow if it can do so more efficiently than the Monitoring RTO (i.e., the Non-Monitoring RTO has a lower shadow price than the Monitoring RTO).

An iterative coordination process will be supported by automated data exchanges in order to ensure the process is manageable in a Real-Time environment. The process of evaluating the shadow prices between the RTOs will continue until the shadow prices are sufficiently close that an efficient redispatch solution is achieved. The continual interactive process over the next several dispatch cycles will allow the transmission congestion to be managed in a coordinated, cost-effective manner by the RTOs. A more detailed description of this iterative procedure will be discussed in Section 3.1.

This coordinated dispatch protocol will be performed any time that an M2M Flowgate under the operational control of either MISO or PJM becomes binding. This approach will produce the level of coordination that will be required to ensure efficient congestion management across the market seams. This approach also will provide a much higher level of interregional congestion management coordination than that which currently exists between any existing adjacent markets.

3.1 Real-Time Energy Market Coordination Procedures

The following procedure will apply for managing M2M Flowgates in the real-time energy market:

1. The RTOs will exchange topology information to ensure that their respective market software is consistent.
2. When any of the M2M Flowgates under a Monitoring RTO's control is identified as a transmission constraint violation, the Monitoring RTO will enter the M2M Flowgate into its security-constrained dispatch software, setting the flow limit equal to the appropriate facility rating.
3. The Monitoring RTO will then notify the Non-Monitoring RTO of the transmission constraint violation and will identify the appropriate M2M Flowgate that requires mitigation.
4. When the M2M Flowgate first becomes a binding transmission constraint in the Monitoring RTOs Real-Time security-constrained economic dispatch, the Monitoring RTO will transmit the following information to the Non-Monitoring RTO:
 - Constraint Shadow Price (\$/MW) - output of the RTOs Real-Time market software.
 - Current Market Flow contribution by the Monitoring RTO on M2M Flowgate (MW) - output of the Real-Time market software.
 - Amount of MWs requested to be reduced from the current Market Flow of the Non-Monitoring RTO. This number will change throughout the iterative process to efficiently resolve constraints.
5. The Non-Monitoring RTO will enter the M2M Flowgate into its security-constrained dispatch software, setting the flow limit on the M2M Flowgate equal to its current Market Flow minus the relief requested by the Monitoring RTO.
 - (a) This means the Non-Monitoring RTO will attempt to manage the flow on the M2M Flowgate at its current Market Flow amount or less, such that it will not contribute any additional flow on the limited M2M Flowgate during this time period.
6. If the Non-Monitoring RTO has sufficient generation to be redispatched, it will redispatch its generation to control the M2M Flowgate until one of the following conditions is reached:
 - (a) The Non-Monitoring RTO has provided the relief requested by the Monitoring RTO.
 - (b) The Non-Monitoring RTO has provided relief at a cost as high as the current shadow price from the Monitoring RTO.
7. The Non-Monitoring RTO will then transmit the following information to the Monitoring RTO:

- Constraint Shadow Price (\$/MW) - Output of the RTOs Real-Time market software. (If the M2M Flowgate does not result in a binding constraint in the Non-Monitoring RTO's security-constrained economic dispatch, then the shadow price is zero and the Flow Relief is zero for the Non-Monitoring RTO.)
 - Current Market Flow contribution by the Non-Monitoring RTO on M2M Flowgate (MW) - Output of the RTO's Real-Time market software.
8. Over the next several dispatch cycles the Monitoring RTO may request the Non-Monitoring RTO to adjust its flow limit up or down. The Monitoring RTO will continue to control the M2M Flowgate respecting the appropriate rating of the facility.
 9. As the relief provided by the Non-Monitoring RTO is realized in the M2M Flowgate, the Monitoring RTO can control the M2M Flowgate at a lower shadow price since less relief is needed from the Monitoring RTO. The updated shadow price will be sent to the Non-Monitoring RTO. The Non-Monitoring RTO will then control the M2M Flowgate using the latest shadow price from the Monitoring RTO as the shadow price limit.
 10. Throughout the period that the transmission constraint violation exists, the RTOs will continue to share the flow and constraint shadow price information that is described above. The shadow prices of the two RTOs will eventually converge towards the most cost-effective redispatch solution, provided both RTOs have sufficient redispatch capability. The information transferred via these data exchanges will be retained to provide the pertinent data for Market Settlements.
 11. Every 15 to 30 minutes as necessary, the Monitoring RTO will review the constraint shadow price comparison, make required adjustments, and communicate any such adjustments to the Non-Monitoring RTO. This process will continue until the Monitoring RTO determines that the cost of further adjustments to the dispatch of the Non-Monitoring RTO would exceed the cost of relieving the transmission constraint by adjusting the Monitoring RTO's own dispatch.
 12. The start and stop times for such Constrained Operation events involving M2M Flowgates will be logged for Market Settlements purposes.

3.2 Real-Time Energy Market Settlements

The Market Settlements under the coordinated congestion management will be performed based on the Real-Time Market Flow contribution on the transmission flowgate from the Non-Monitoring RTO as compared to its flow entitlement.

If the Real-Time Market Flow less the Generator Pseudo-Tie Market Flow Adjustment is greater than the flow entitlement plus the Approved MW adjustment from Day Ahead Coordination, then the Non-Monitoring RTO will pay the Monitoring RTO for congestion relief provided to sustain the higher level of Real-Time Market Flow. This payment will be calculated based on the following equation:

$$\text{Payment} = ((\text{Real-Time Market Flow MW}^1 - \text{Generator Pseudo-Tie Market Flow Adjustment}^2) - (\text{Firm Flow Entitlement MW}^3 + \text{Approved MW}^4)) * \text{Transmission Constraint Shadow Price in Monitoring RTOs Dispatch Solution}$$

If the Real-Time Market Flow less the Generator Pseudo-Tie Market Flow Adjustment is less than the flow entitlement plus the Approved MW adjustment from Day Ahead Coordination, then the Monitoring RTO will pay the Non-Monitoring RTO for congestion relief provided at a level below the flow entitlement. This payment will be calculated based on the following equation:

$$\text{Payment} = ((\text{Firm Flow Entitlement MW}^3 + \text{Approved MW}^4) - (\text{Real-Time Market Flow MW}^1 - \text{Generator Pseudo-Tie Market Flow Adjustment}^2)) * \text{Transmission Constraint Shadow Price in Non-Monitoring RTOs Dispatch Solution}$$

For the purpose of settlements calculations, shadow prices will be calculated by the pricing software in the same manner as the LMP, and will be integrated over each hour during which a transmission constraint is being actively coordinated under the ICP by summing the five-minute shadow prices during the active periods within the hour and dividing by 12 (the number of five minute intervals in the hour).

¹ This value represents the Non-Monitoring RTO's Real Time Market Flow.

² This value represents the Generator Pseudo-Tie Market Flow Adjustment as described in Section 11 of this Attachment 3.

³ This value represents the Non-Monitoring RTO's Firm Flow Entitlement.

⁴ This value represents the Approved MW that resulted from the Day Ahead Coordination.

4 Day-Ahead Energy Market Coordination

The Day-Ahead energy market coordination focuses primarily on ensuring that the Day-Ahead scheduled flows on all M2M Flowgates are limited to no more than the Firm Flow Entitlements for each RTO. For the purpose of determining the Firm Flow Entitlement to model in a RTO's Day-Ahead market, either RTO may adjust the Firm Flow Entitlement to align with M2M settlement practices. When system conditions can accommodate the change, either RTO may request that the Day-Ahead flow limit be raised above its Firm Flow Entitlement.

The Day-Ahead energy market redispatch protocol may be implemented in the Day-Ahead energy market upon the request of either RTO if the adjacent RTO verifies that such Day-Ahead redispatch is feasible.

An example of the Day-Ahead energy market protocol is as follows:

1. The Requesting RTO specifies the amount of scheduled flow reduction that it is requesting on a specific M2M Flowgate and communicates the request to the Responding RTO
2. The Responding RTO will then lower the MW limit that it utilizes in its Day-Ahead market on the specified M2M Flowgate by the specified amount. This means that instead of modeling the M2M Flowgate constraint at flow entitlement amount, the Responding RTO will model the constraint as the flow entitlement less the requested MW reduction. Therefore, the Responding RTO will schedule less flow on the specified M2M Flowgate in order to provide Day-Ahead congestion relief for the Requesting RTO. The Requesting RTO may then use the additional MW capability in its own Day-Ahead market.

4.1 Day-Ahead Energy Market Coordination Procedures

The following procedure will apply to the modeling of M2M Flowgates in the Day-Ahead energy markets, unless either the Monitoring RTO or the Non-Monitoring RTO requests specific exceptions.

- Each RTO will model all M2M Flowgates, for which it is the Reliability Coordinator, in its Day-Ahead market and Day-Ahead reliability analyses, with the limit set equal to the applicable facility limit less the Firm Flow Entitlement of the Non-Monitoring RTO.
- Each RTO will model all M2M Flowgates, for which it is NOT the Reliability Coordinator, in its Day-Ahead Market and Day-Ahead reliability analysis with the limit set equal to its Firm Flow Entitlement for that M2M Flowgate.
- The Monitoring RTO will include an appropriate loop flow model in its Day-Ahead process. However, this loop flow model will not account for loop flows contributed by deliveries associated with the Non-Monitoring RTO market since these flows are accounted for by the Firm Flow Entitlement.

An M2M Flowgate limit exception is a request to alter the M2M Flowgate limits, as described above, that will be modeled in the Day-Ahead markets and/or the Day-Ahead reliability analysis. The following procedure will apply for designating M2M Flowgate limit exceptions:

1. If the Requesting RTO identifies a need to utilize more of an M2M Flowgate than it is entitled, it may request the Responding RTO to lower its Day-Ahead Market limit below its Firm Flow Entitlement by a specified amount and range of hours. The Requesting RTO must request the adjustment from the Responding RTO as soon as possible but not later than one hour prior to the Responding RTO's deadline for submitting bids and offers in the day-ahead market.
2. If the Responding RTO agrees to provide the limit reduction, it will communicate the approved amount to the Requesting RTO as soon as possible but not later than the Requesting RTO's deadline for submitting bids and offers in the Day-Ahead Market.
3. The Requesting RTO may increase its limit on the M2M Flowgate by the agreed upon and specified amount and range of hours.
4. Either Party may rescind the agreement up to one hour after the Responding RTO's deadline for submitting bids and offers in the day-ahead market.

For the purpose of modeling generator pseudo-tie impacts in the Day-Ahead market, the RTOs will determine the amount of impact on M2M Flowgates based on Market Participant quantities offered in the Day-Ahead market. The impact for a pseudo-tied generator will be determined appropriately by the RTOs, e.g. from the generator

specific location to the MISO-PJM border. Either RTO may adjust and coordinate the M2M Flowgate limit to align with M2M settlement formulas and practices.

4.2 Day-Ahead Energy Market Settlements

The market settlements for Day-Ahead congestion relief will be performed in a similar manner to the Real-Time energy market settlements of the coordinated congestion management protocol. The Day-Ahead payment for the RTO that is requesting congestion relief will be calculated as follows:

**Payment = Approved MW * Transmission Constraint Shadow Price
in Responding RTOs Dispatch Solution**

This payment will be calculated based on the hourly Day-Ahead Market results. If such congestion relief is requested and performed on a Day-Ahead basis, then the Real-Time flow entitlement for the affected hours in the corresponding Real-Time market will be adjusted accordingly.

5 Auction Revenue Rights (ARR) Allocation/Financial Transmission Rights (FTR) Auction Coordination

The allocation of ARR and FTR products in each marketplace must recognize the Firm Flow Entitlement that exists in adjacent markets. The ARR allocation and FTR Auction model will contain the same level of detail for adjacent regions as the Day-Ahead market model and the Real-Time market model. Each RTO will allocate ARRs via Annual ARR Allocation award, and award FTRs via Annual and Monthly FTR Auction to Network and Firm Transmission customers subject to their participation and simultaneous feasibility test that determines the amount of transmission capability that exists to support the ARRs and FTRs.

The simultaneous feasibility analysis for each RTO will model that RTO's Firm Flow Entitlement on the transmission flowgates in the adjacent region as the Market Flow limit that must be respected in the ARR Allocation and FTR Auction processes. For the purposes of determining the Firm Flow Entitlement to model in a RTO's FTR market, either RTO may adjust the Firm Flow Entitlement to align with M2M settlement practices. The transmission flowgates in each RTO will be modeled in the simultaneous feasibility test at a capability value equal to the flowgate rating minus the Firm Flow Entitlement that exists for flows from the adjacent market. In this way, the ARR Allocation and the FTR Auction across both RTOs will recognize the reciprocal transmission utilization that exists for Network and Firm transmission customers in both markets.

6 Coordination Example

The following example illustrates the Real-Time coordination of an M2M Flowgate, specifically describing the following five stages:

- Stage 1: Initial Conditions & Energy Prices at Border
- Stage 2: Transmission Constraint Initialization & Energy Prices at Border
- Stage 3: First Coordinated Interregional RTO Dispatch Cycle (Constraint Binds in Monitoring RTO) & Energy Prices at Border
- Stage 4: First Coordinated Interregional RTO Dispatch Cycle (Constraint Binds in Non-Monitoring RTO) & Energy Prices at Border
- Stage 5: Ongoing Coordinated Dispatch Cycles

Stage 1 – Initial Conditions

- Marginal Losses are not utilized in this example for ease of understanding
- RTO A is the Non-Monitoring RTO, its system marginal price is \$35/MWh
- RTO B is the Monitoring RTO, its system marginal price is \$40/MWh
- Generator 1 is on-line and dispatched to full output, its dispatchable range is 100 MW
- Generators 2 and 3 are both off-line; they are both 20 MW quick start CTs
- M2M Flowgate A has a limit of 100 MW with the actual flow at 95 MW

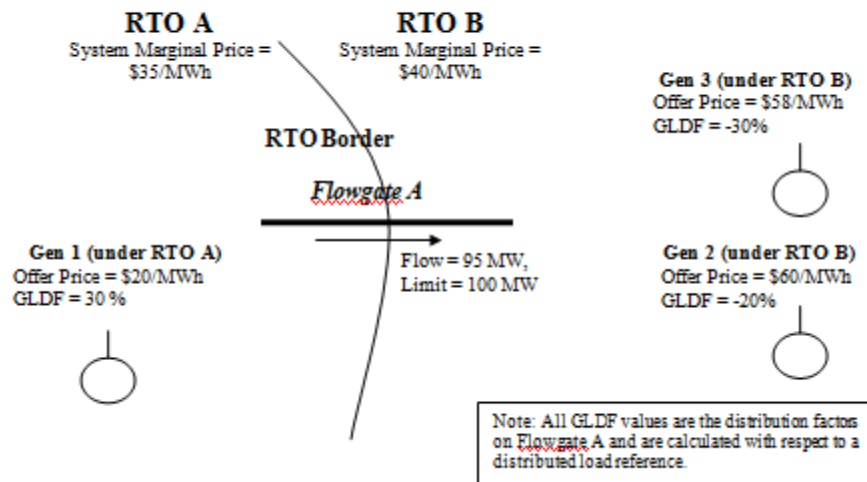

Stage 1 - Energy Prices at the RTO Border (Proxy Bus Prices)

The proxy bus prices will be calculated for each stage of the congestion management example. These examples illustrate that the proxy bus prices will move in the same direction as the constrained bus prices when the M2M Flowgate is binding in both RTO security-constrained economic dispatches. The LMPs throughout both RTOs are equal to their System Marginal Price so long as the RTOs are unconstrained (no binding constraint resulting in redispatch of generation). This example also ignores marginal losses to simplify the illustration.

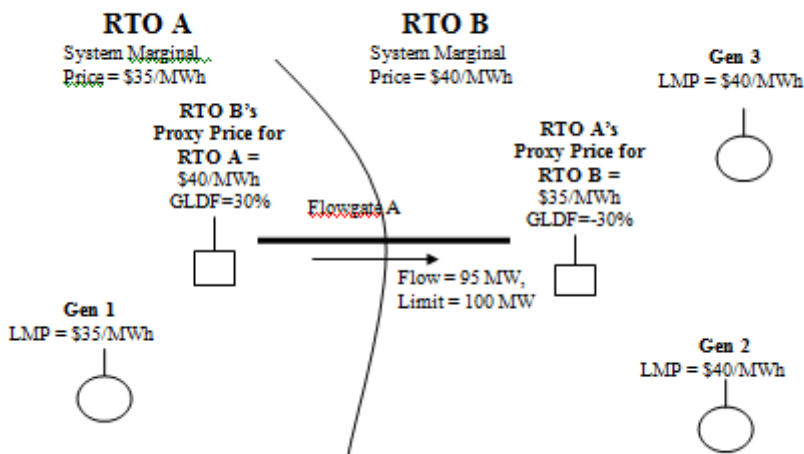

Stage 2 - Transmission Constraint Initialization

The RTO B (Monitoring RTO) dispatch software is projecting that the flow on Flowgate A is increasing and that **9 MW of flow relief** will be required. (Note: The 9 MW is derived from RTO B's look-ahead dispatch software along with a parallel path evaluation). The security-constrained dispatch solution for RTO B results in both Generator 2 and Generator 3 being dispatched; the system marginal price for RTO B remains at \$40/MWh. Generator 3 is the most cost effective unit to control the constraint.

The Flowgate A constraint shadow price for RTO B will be equal to:

$$(\text{Gen 2 Offer Price} - \text{System Marginal Price for RTO B}) / (\text{Generator 2 GLDF on Constraint})$$

$$(\$60/\text{MWh} - \$40/\text{MWh}) / -0.20 = -\$100/\text{MW of Flow Relief.}^4$$

⁴ The transmission constraint shadow price is calculated based on the difference between the constrained on generator offer price and the system marginal price. This difference is then divided by the GLDF of the generator on the binding constraint. In this case, Generator 2 drives the constraint shadow price because it has the highest offer and the lowest GLDF.

The LMP for Gen 2 will be:

System Marginal Price for RTO B + (Gen 2 GLDF)(RTO B Shadow Price)

$$\$40/\text{MWh} + (-.2)(-\$100/\text{MWh flow relief}) = \$60/\text{MWh}$$

The LMP for Gen 3 will be:

System Marginal Price for RTO B + (Gen 3 GLDF)(RTO B Shadow Price)

$$\$40/\text{MWh} + (-.3)(-\$100/\text{MWh flow relief}) = \$70/\text{MWh}$$

The conditions for Stage 2, the initial transmission constrained scenario, are as follows:

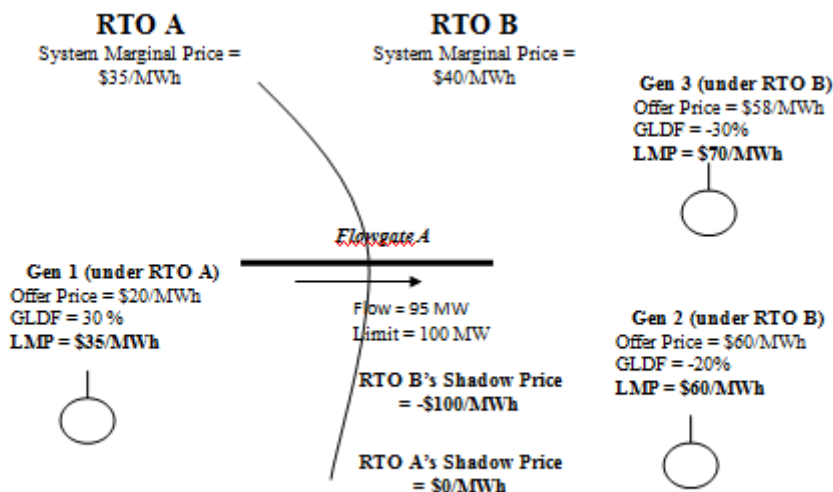

Stage 2 - Energy Prices at the RTO Border (Proxy Bus Prices)

The proxy bus price for RTO A as calculated by RTO B will include the impact of the constraint on Flowgate A.

- Since the constraint is not binding in RTO A in Stage 2, the proxy price for RTO B as calculated by RTO A will remain at the system marginal price of RTO A.
- Since the proxy bus prices for each RTO reflect the value of imports or exports from the neighboring RTO, these proxy prices will be set by the system marginal price in the RTO that is calculating the proxy price.

RTO B's Proxy price for RTO A is as follows:

System Marginal Price for RTO B + (Proxy bus GLDF)(RTO B Shadow Price)

$$\$40/\text{MWh} + (.3)(-\$100/\text{MWh flow relief}) = \$10/\text{MWh}$$

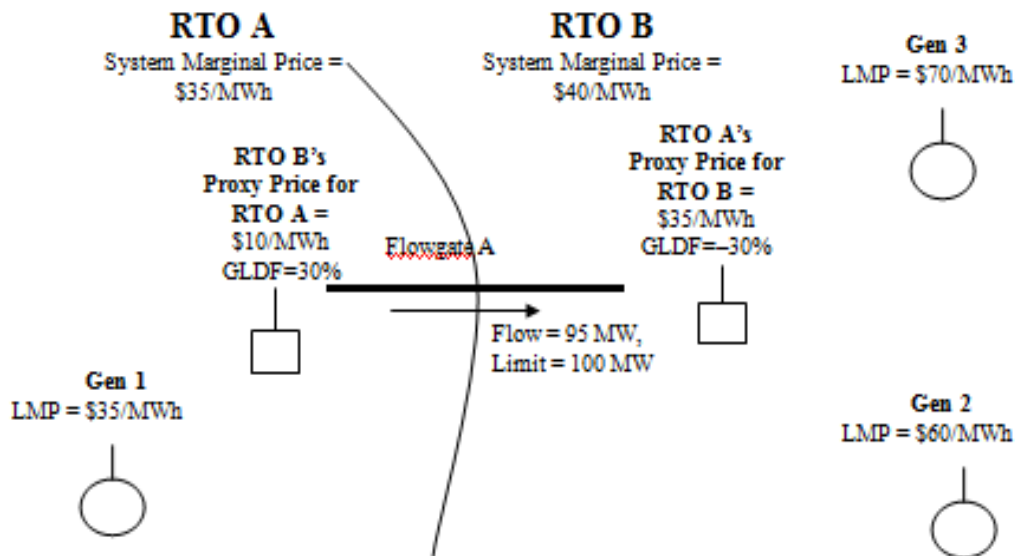

Stage 3 – First Coordinated Interregional RTO Dispatch Cycle (Constraint Binds in Monitoring RTO)

- RTO B notifies RTO A of the transmission constraint Condition on Flowgate A. Initially RTO B requests RTO A to maintain its current Market Flow on Flowgate A. RTO B sends its latest shadow price of -\$100/MWh to RTO A.
- RTO A enters the constraint into its security-constrained dispatch software with the current flow equal to the limit using -\$100/MWh as its shadow price limit. (The current flow equals 35 MW in this case.) Since RTO A’s load is growing, the constraint binds with a shadow price less than the -\$100/MWh limit. (Assume Firm Flow is 40 MW.).

Flowgate A constraint shadow price for RTO A will be equal to:

(Gen 1 Offer Price – System Marginal Price for RTO A)/(Gen 1 GLDF on Constraint)

$$(\$20/\text{MWh} - \$35/\text{MWh}) / 0.30 = -\$50/\text{MW of Flow Relief.}^5$$

The LMP for Gen 1 will be:

System Marginal Price for RTO A + (Gen 1 GLDF)(RTO A Shadow Price)

$$\$35/\text{MWh} + (.3)(-\$50/\text{MWh flow relief}) = \$20/\text{MWh}$$

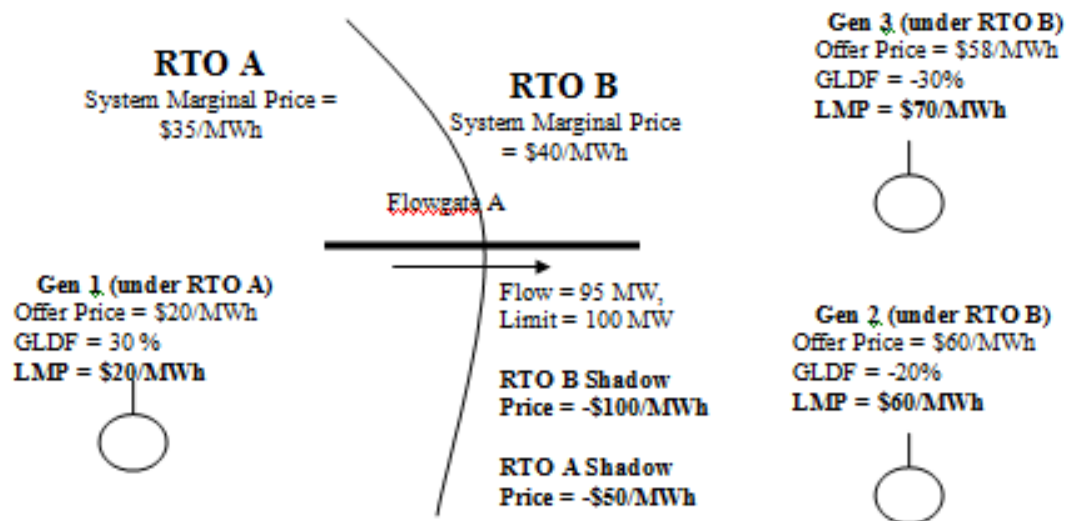

⁵The transmission constraint shadow price is calculated based on the difference between the constrained on generator offer price and the system marginal price. This difference is then divided by the GLDF of the generator on the binding constraint. In this case, Generator 2 drives the constraint shadow price because it has the highest offer and the lowest GLDF. The resulting shadow price of -\$50/MWh is less than the limit of -\$100/MWh from the Monitoring RTO A.

Stage 3 - Energy Prices at the RTO Border (Proxy Bus Prices)

The proxy bus price for RTO A as calculated by RTO B, will include the impact of the constraint on Flowgate A. Since the constraint is now binding in RTO A in stage 3, the proxy price for RTO B as calculated by RTO A will include impact of the constraint on Flowgate A.

RTO A's Proxy price for RTO B is as follows:

System Marginal Price for RTO A + (Proxy bus GLDF)(Shadow Price)

$$\$35/\text{MWh} + (-.3)(-\$50/\text{MWh flow relief}) = \$50/\text{MWh}$$

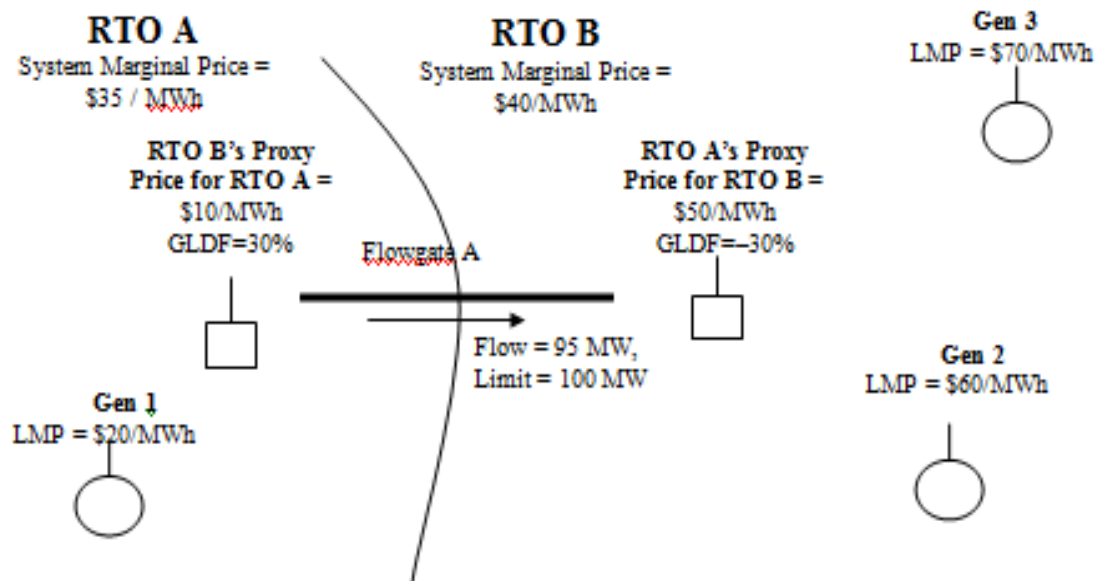

Stage 4 – First Coordinated Interregional RTO Dispatch Cycle (Constraint Binds in Non-Monitoring RTO)

RTO B analyzes the constraint shadow price information and determines that RTO A has a more economical alternative to provide the Flow Relief than is currently being obtained by operating Generator 2 out of merit. The analysis results in RTO B requesting RTO A to provide 4 MW more of Flow Relief to enable Generator 2 to come offline.

RTO A is able to reduce its Market Flow on Flowgate A to the desired 31 MW limit in its dispatch software. RTO A can achieve the requested relief by lowering Gen 1 while observing the shadow price limit from RTO B.

After the flow on Flowgate A is reduced by the redispatch action from RTO A, RTO B requests Generator 2 to come off-line, because it will no longer be required to control the Flowgate A limit.

The Flowgate A constraint shadow price for RTO B will be equal to:

$$\text{(Gen 3 Offer Price – System Marginal Price for RTO B)/(Generator 3 GLDF on Constraint)} \\ (\$58/\text{MWh}-\$40/\text{MWh}) /-0.30 = -\$60/\text{MW of Flow Relief.}^6$$

The LMP for Gen 2 will be:

$$\text{System Marginal Price for RTO B + (Gen 2 GLDF)(RTO B Shadow Price)} \\ \$40/\text{MWh} + (-.2)(-\$60/\text{MWh flow relief}) = \$52/\text{MWh}$$

The LMP for Gen 3 will be:

$$\text{System Marginal Price for RTO B + (Gen 3 GLDF)(RTO B Shadow Price)} \\ \$40/\text{MWh} + (-.3)(-\$60/\text{MWh flow relief}) = \$58/\text{MWh}$$

⁶The transmission constraint shadow price is calculated based on the difference between the constrained on generator offer price and the system marginal price. This difference is then divided by the GLDF of the generator on the binding constraint. In this case, Generator 3 drives the constraint shadow price because it is the only unit online for the constraint.

The conditions for Stage 4 are as follows:

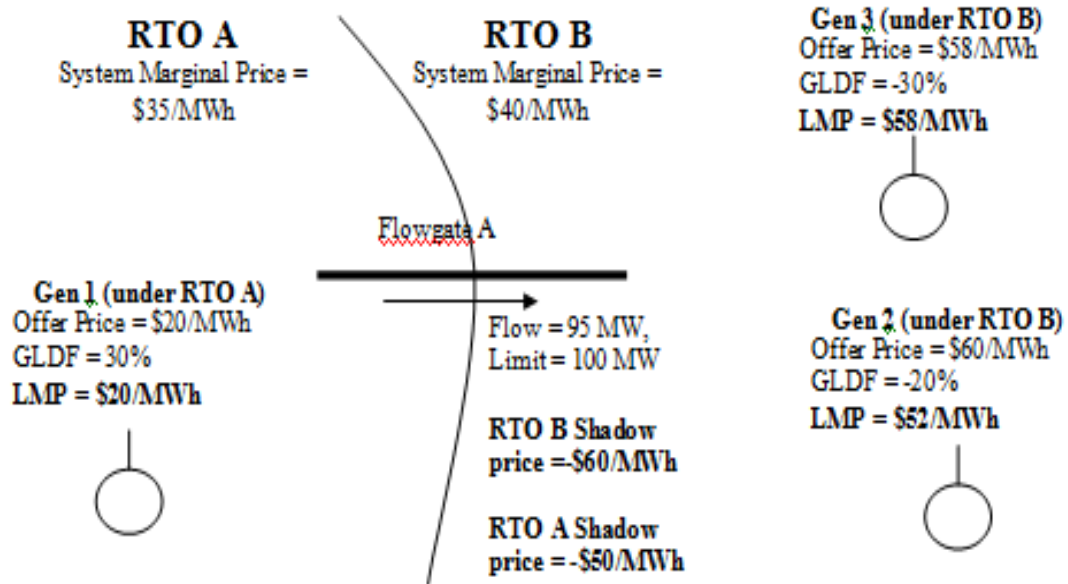

Stage 4 - Energy Prices at the RTO Border (Proxy Bus Prices)

The proxy bus price for RTO A, as calculated by RTO B, will include the impact of the constraint on Flowgate A. Since the constraint remains binding in RTO A in Stage 4, the proxy price for RTO B as calculated by RTO A will include impact of the constraint on Flowgate A.

RTO B's Proxy price for RTO A is as follows:

System Marginal Price for RTO B + (Proxy bus GLDF)(RTO B Shadow Price)

$$\$40/\text{MWh} + (.3)(-\$60/\text{MWh flow relief}) = \$22/\text{MWh}$$

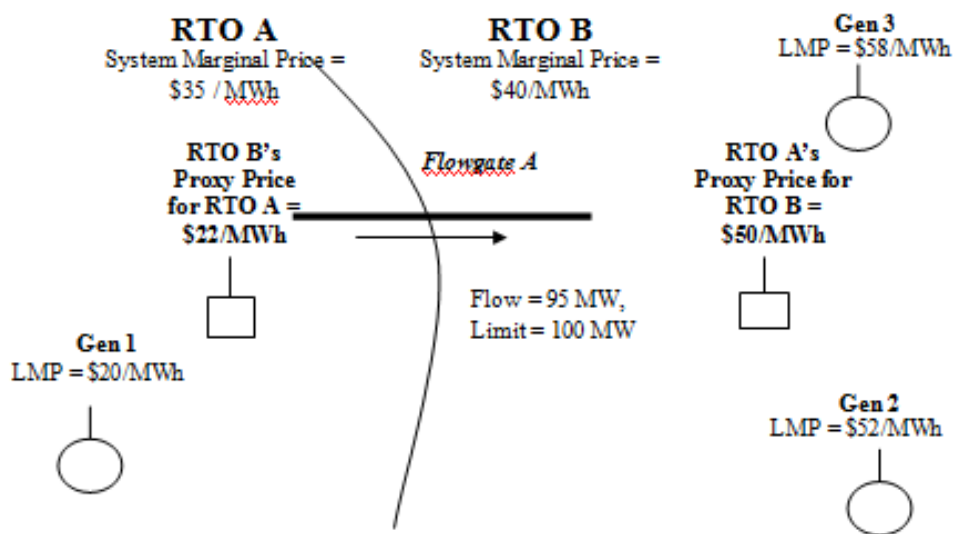

Stage 5 – Ongoing Coordinated Dispatch Cycles

As the constrained operations progress, the RTOs will periodically verify that the constrained operations are coordinated by ensuring that the constraint shadow prices are reasonably close for the given constrained scenario.

In this case, the RTO A shadow price is \$50/MWh and the RTO B shadow price is \$60/MWh, which indicates that the system is optimally coordinated for the given constrained condition.

The RTO B's proxy bus price for RTO A is \$22/MWh which is very close to the LMP at Gen 1 bus (\$20/MWh) in RTO A. The RTO B's proxy bus for RTO A and the Gen 1 bus both have +30% GLDF on Flowgate A. One of the objectives of the market-to-market coordination is to achieve price convergence for buses with similar GLDFs across the RTO border. Similarly, the RTO A's proxy bus price for RTO B is \$50/MWh which is reasonably close to the LMP at Gen 3 bus (\$58/MWh) in RTO B. The RTO A's proxy bus for RTO B and the Gen 3 bus both have -30% GLDF on Flowgate A.

Settlement calculations

Stages 4 and 5 are the steady state situation integrated over an hour.

Firm Flow Entitlement for RTO A on Flowgate A per the example = 40MW

Real-Time Market Flow MW by RTO A on Flowgate A = 31MW (requested by RTO B)

RTO A Shadow Price on Flowgate A = -\$50/MWh

Payment (RTO B to RTO A) = ((Firm Flow Entitlement MW + Approved MW) – Real-Time Market Flow MW) * Transmission Constraint Shadow Price in Non-Monitoring RTOs Dispatch Solution

Payment (RTO B to RTO A) = ((40/MWh + 0) - 31/MWh)*-\$50/MWh

Payment (RTO B to RTO A) = \$450

7 When One of the RTOs Does Not Have Sufficient Redispatch

The purpose of this Section 7 is to establish rules for determining shadow prices on a constrained (i.e., binding) M2M Flowgate where either Party has insufficient redispatch to control the constrained M2M Flowgate. A Party has insufficient redispatch if the Party's market clearing software that clears the real-time energy market cannot produce a solution that manages the flow on a constrained (i.e., binding) M2M Flowgate within the binding limit in a dispatch interval at a cost less than or equal to the Transmission Constraint Penalty Factor.

A Party with insufficient redispatch to control a constrained M2M Flowgate shall either: (1) allow the Transmission Constraint Penalty Factor to set the shadow price of the constrained M2M Flowgate; or (2) upon mutual agreement of both Parties, apply the Constraint Relaxation Logic in accordance with the Party's Governing Documents. If the Constraint Relaxation Logic is implemented, the Monitoring RTO or the Non-Monitoring RTO binds for the constrained M2M Flowgate, and such RTO cannot provide sufficient redispatch to reach the shadow price of the other RTO, the Constraint Relaxation Logic shall be deactivated and the RTO binding for the constrained M2M Flowgate that cannot provide sufficient redispatch shall use the other RTO's shadow price.

8 Appropriate Use of the Market-to-Market Process

Under normal operating conditions, the MISO and PJM operators will model all Reciprocal Coordinated Flowgates (RCFs) in their respective EMSs. A subset of these Flowgates, impacted by Market Flows from the two RTOs' energy markets, will be subject to the market-to-market process and called M2M Flowgates. This subset will be controlled using market-to-market tools for coordinated redispatch and additionally will be eligible for market-to-market settlements.

In principle and as much as practicable, Parties agree that the goal is to control to the most limiting Flowgate using the actual Flowgate limit. The RTOs will record and exchange actual M2M Flowgate limits, the limit used to bind, and a reason for significant deviation.

There are times when either Party, acting as the Monitoring RTO, will bind a M2M Flowgate different from its actual limit. The Parties have agreed in subsections 8.1 through 8.4 of this Section_8 to the conditions under which market-to-market settlement will occur even though a limit to which the Monitoring RTO is binding (limit control) is less than its actual limit.

8.1 Qualifying Conditions for M2M Settlement:

8.1.1 Purpose of Market-to-Market. Market-to-market was established to address regional, not local issues. The intent is to implement market-to-market coordination and settle on such coordination where both Parties have significant impact.

8.1.2 Minimizing Less than Optimal Dispatch. The Parties agree that, as a general matter, they should minimize financial harm to one RTO that results from market-to-market coordination initiated by the other RTO that produces less than optimal dispatch, which can lead to revenue inadequacy for FTRs, and impose the burden for such revenue inadequacy on one or both RTOs.

8.1.3 Use Market-to-Market Whenever Binding a M2M Flowgate. The market-to-market process will be initiated by the Monitoring RTO whenever an M2M Flowgate is constrained and therefore binding in its dispatch.

8.1.4 Most Limiting Flowgate. Generally, controlling to the most limiting Flowgate provides the preferable operational and financial outcome. In principle and as much as practicable, market-to-market coordination will take place on the most limiting Flowgate, and to that Flowgate's actual limit (thermal, reactive, stability).

- a. Market-to-market events that involve the use of a limit control that is below 95% of the actual limit will be subject to an after-the-fact review, unless the lower limit was agreed to by the RTOs prior to the market-to-market binding event. The review will determine if normal market-to-market settlements are appropriate. If market-to-market settlements are determined by the Parties not to be appropriate, then settlements will not occur on the M2M Flowgate. Sufficient real-time and after-the-fact data will be exchanged to enable these reviews. The Parties may agree to

change the trigger for review to a lower number for specific Flowgates, however, either Party may request review of specific instances that are bound above the established binding percentage

8.1.5 Substitute Flowgates. The Parties agree that, if the use of substitute Flowgates is minimized and the ability to coordinate on the most limiting Flowgate in the very near term is enabled, there should be very few instances where market-to-market coordination occurs without resulting settlement.

- a. Generally, market-to-market coordination without the normal market-to-market settlement will be limited to times when: (1) a substitute is used for a period in excess of that defined in Section 8.1.5 (b) (ii) below, or (2) a substitute Flowgate (whether M2M or non-M2M) is used and the most limiting Flowgate is later determined to fail the market-to-market tests.
- b. Where the most limiting constraint (monitored/contingent element pair) is not a defined M2M Flowgate:
 - i. Parties will add the Flowgate definition and activate market-to-market coordination on that Flowgate (as opposed to a substitute) as soon as reasonably practicable; or
 - ii. A substitute Flowgate may be used for a short time (generally less than an hour) until it is possible to coordinate using the most limiting Flowgate. Parties will attempt to use either: (i) the most limiting M2M Flowgate or (ii) the most limiting Flowgate that is modeled by both Parties, in that order of preference. If possible, the Parties should use another Flowgate that is limiting. Optimal choices are Flowgates with the same or very similar Market Flow impacts (sensitivities) resulting in a very similar redispatch and market-to-market settlement.
- c. A substitute Flowgate can be used in the market-to-market process pending the outcome of the coordinated Flowgate tests. The substitute Flowgate will be utilized only until the actual constraint can be entered in both the Monitoring and Non-Monitoring RTO systems as an M2M Flowgate. Market-to-market settlement is dependent on the outcome of the coordinated Flowgate tests on the actual constraint and the RTO requesting the use of a substitute Flowgate will do so at its own risk that market-to-market settlement may not occur.
- d. A substitute M2M Flowgate will not be used to control for another constrained M2M Flowgate except in very limited circumstances and only where there is prior mutual agreement between MISO and PJM to do so. Mutual agreement is established only when it has been communicated and logged by the control center operators that the coordinated Flowgate is not the most limiting (i.e., it is a substitute Flowgate).

- e. A substitute M2M Flowgate will not be used to control for a non-M2M Flowgate that has failed the Flowgate study or has not been entered into the study process.
- f. Any use of substitute Flowgate should be clearly logged by both RTO operators with the actual start time, the actual end time and the reason for using a substitute Flowgate.
- g. If the Monitoring RTO requests TLR on an M2M Flowgate but has not initiated the market-to-market process and is not binding its market for that Flowgate, the Non-Monitoring RTO is not required to bind its market for that Flowgate in order to meet the Non-Monitoring RTO's TLR relief obligation. It will be assumed that the Monitoring RTO is binding its market for the actual constraint and that the actual constraint is already active in the market-to-market process (if the actual constraint is an M2M Flowgate).

8.1.6 Operating Guides that refer to market-to-market operation do so under the assumption that the Flowgates for which market-to-market operations take place are, or are expected to be, constrained. Operating Guides are written by operators and are not intended to result in settlement not otherwise contemplated by the JOA or this ICP. Safe Operating Mode (SOM) is reserved for abnormal conditions when existing operating guides and normal tool sets are not sufficient to manage abnormal operating conditions. After declaring SOM, operator actions may include using market-to-market tools in addition to direct dispatch. Operators may choose to use substitute M2M Flowgates with the dispatch tools to maintain reliable operations. Settlement determination will occur during the After-the-Fact Review set forth in Section 8.4 below. Generally, settlement for market-to-market coordination that takes place after SOM is declared will apply if the settlement would apply under normal conditions.

8.2 Specific Conditions Applicable to Section 8.1.4 (Most Limiting Flowgate)

8.2.1 Market-to-Market Events Not Requiring an After-the-Fact Review

The MISO and PJM operators will model all M2M Flowgates facilities with actual limits in their respective EMSs. The MISO EMS model uses design thermal limits of equipment. The MISO limits are updated in UDS following contacts with Transmission Owners prior to binding. The MISO and PJM operators will control the flows on these M2M Flowgates in their respective UDSs at a binding percentage that is 95% or greater of the M2M Flowgate actual limit.

8.2.2 Market-to-Market Events Requiring an After-the-Fact Review

All M2M events that involve the use of a limit control that is below 95% of the actual limit will be subject to an after-the-fact review to determine whether this was an appropriate use of the market-to-market process and is subject to normal market-to-

market settlement. The following criteria will be used in making such a determination:

8.2.2.1 Reducing the UDS Binding Percentage to Provide Necessary Constraint Control:

- a. A reduced UDS binding percentage below 95% of the actual facility limit can be applied to an M2M Flowgate by the Monitoring RTO provided the monitored element (for the defined contingency condition) of the M2M Flowgate meets the following conditions:
 - i. The monitored element is, or is expected to be, over its actual limit (post contingency if applicable) and the UDSs are not providing the desired relief.
 - ii. Transient system behavior necessitates controlling the M2M Flowgate to a target between 95% and 100% and providing some margin. To achieve this, in some instances, the UDS percentage may need to be below 95%.
 - iii. The limit for the monitored element changes due to equipment switching out of service. For instance the actual limit of a line is reduced when one of the breakers in a breaker-and-half configuration is out of service, or only one parallel transformer remains in service at one of the line end terminals.
 - iv. A constraint with a very high loading volatility such that loading is expected to exceed 100% of the actual limit, even when the UDS binding percentage is significantly below that value.
- b. The reduced UDS binding percentage should only be applied for the time duration necessary to manage the initiating condition and shall be returned to normal as soon as possible.
- c. Each time the Monitoring RTO reduces the binding limit control of an M2M Flowgate below 95% for an actual or relevant post contingency overload, the Monitoring RTO operator will make a best effort to notify the Non-Monitoring RTO operator of the new limit control, the reason for the change, and when the limit control is expected to be returned to normal (if known). Both RTO operators will log the event. This notification only applies to an operating condition causing a limit control change; it does not apply to the use of temperature adjusted limits, voltage limits or stability limits implemented as flow limits.
 - i. A limit reported by a Transmission Owner on the operating day shall require an accompanying reason. If the limit is set to control for underlying facilities, this shall be called out specifically. Any reason other than those specifically called out herein shall be reported.

- d. The Monitoring RTO will operate to the most conservative limit when there are conflicting results between two different EMSs (either another RTO EMS or a Transmission Owner EMS) unless the reason for the difference is known.

8.2.2.2 Reducing the UDS Binding Percentage of a M2M Flowgate for Prepositioning

- a. In some conditions system flows are expected to change quickly due to load pick-up, planned, and emergency outages, and the UDS may not be accurately predicting a resulting overload on the M2M Flowgate in the near future. When a reduction in binding percentage is initiated by the operator to mitigate expected impacts on an M2M Flowgate from a planned outage, that action shall be taken to prepare the system consistent with the time submitted on the outage ticket or as revised by the equipment operator. This reduction should be for as short a time as practicable but may be extended if the outage is delayed. If possible, initiating the reduction in binding percentage shall be delayed until the outage begins.
- b. M2M Flowgates may be de-rated for a short period of time to pre-position the system for an expected change. These expected changes can include:
 - i. Change in unit status (anticipated as part of an upcoming outage, reacting to an imminent emergency outage, or change in commitment if the unit for which the commitment was changed cannot be adequately ramped to allow normal redispatch to manage any resulting constraints).
 - ii. Transmission system topology change (either anticipated event or as part of an upcoming planned outage). In this case, every effort shall be made to add the expected constraint to the systems and bind on the expected constraint instead of using a substitute Flowgate.
 - iii. Increase or decrease in wind generation output.
- c. Reducing the limit to pre-position the system will be considered an appropriate use of market-to-market tools but subject to settlement adjustment for substitute M2M Flowgates applying a hold harmless approach discussed in the After the Fact Review process set forth in Section 8.4 below. The time duration of such events shall be limited to that necessary to pre-position to avoid excessive impacts on market prices.

8.3 Specific Conditions Applicable to Section 8.1.6 (Operating Guides)

8.3.1 All op guides are subject to review by MISO and PJM through which either RTO can request removal of a reference to the market-to-market process. Where reference to the market-to-market process has been removed and not replaced by alternate congestion management actions, the use of SOM will be added to the op guide if it is not already included in the op guide. Before modifying existing op guides, one of the following conditions must be met:

- a. One or more constraints are made available to assist in managing West-to-East flows across NIPS to avoid the conditions that prompted SOM; or
- b. MISO and PJM will agree to a mechanism to manage congestion that will avoid the need for repeated SOM declarations on the same constraint.

8.3.2 In the event of severe abnormal system conditions, such as storm damage to critical facilities, the Inter-RTO Steering Committee shall meet as soon as practicable to agree upon the response, which shall be incorporated into a temporary operating guide.

8.4 After-the-Fact Review to Determine Market-to-Market Settlement

8.4.1 Based on the communication and data exchange that has occurred in real-time between the Monitoring RTO operator and the Non-Monitoring RTO operator, there will be an opportunity to review the limit change and the use of the market-to-market process to verify it was an appropriate use of the market-to-market process and subject to market-to-market settlement. The Monitoring RTO will initiate the review as necessary to apply these conditions and settlements adjustments.

- a. A review will verify that the limit used in the market-to-market coordination represented the actual limit of the monitored element of the original Flowgate that has passed one of the M2M Flowgate Studies. The Monitoring RTO will archive and make available data (including all UDS solutions) that supports the decision to change the M2M Flowgate limit. The Parties will mutually agree upon, and document in writing and post on the Parties' websites, the data that should be exchanged and/or archived to meet this requirement, and shall retain the data for the period applicable to other data used to audit settlements inputs and Market Flow calculations under this agreement.
- b. A review will verify the outcome of the M2M Flowgate Studies and whether the potential Flowgate passed one of the M2M Flowgate Studies by both the Monitoring RTO and the Non-Monitoring RTO. The Monitoring RTO uses market-to-market tools before a M2M Flowgate is approved at its own risk regarding market-to-market settlement. After the M2M Flowgate Studies are complete, if the Flowgate did not pass at least one of the studies conducted by

the Monitoring RTO and at least one of the studies conducted by the Non-Monitoring RTO, then settlements will be adjusted as follows.

- i. If the Non-Monitoring RTO's integrated Market Flows are below its Firm Flow Entitlement for the hour, there will be a normal market-to-market settlement with a payment from the Monitoring RTO to the Non-Monitoring RTO for the hour.
- ii. If the Non-Monitoring RTO's integrated Market Flows exceed its Firm Flow Entitlement for the hour, there will be no market-to-market settlement for the hour.
- iii. If the Monitoring RTO was requested to initiate the market-to-market process on the Monitoring RTO's Flowgate to assist the Non-Monitoring RTO, the Monitoring RTO will be held harmless as follows.
 - a. If the Non-Monitoring RTO's integrated Market Flows are below its Firm Flow Entitlement for the hour, there will be no market-to-market settlement for the hour.
 - b. If the Non-Monitoring RTO's integrated Market Flows exceed its Firm Flow Entitlement for the hour, there will be a normal market-to-market settlement with a payment from the Non-Monitoring RTO to the Monitoring RTO for the hour.

8.4.2 The Non-Monitoring RTO may request the Monitoring RTO to implement the market-to-market process on its behalf. There will be an after the fact review performed to determine whether this market-to-market event should be subject to settlement. If the review finds it is subject to settlement, the usual criteria will be applied. If the review finds it is not subject to settlement, the usual criteria will be applied except that the Monitoring RTO shall be held harmless.

- a. If the Non-Monitoring RTO's integrated Market Flows are below its Firm Flow Entitlement for the hour, there will be no market-to-market settlement for the hour.
- b. If the Non-Monitoring RTO's integrated Market Flows exceed its Firm Flow Entitlement for the hour, there will be a normal market-to-market settlement with a payment from the Non-Monitoring RTO to the Monitoring RTO for the hour.

8.5 M2M Data Exchange

8.5.1 A data exchange will be established. Parties shall mutually agree upon data, format and frequency of exchanges. The data exchange must be updated to include the following data as soon as practicable if requested by either Party.

- a. actual Flowgate SE/SA flow from the approved case,
- b. UDS solution %,
- c. operator entered binding %,
- d. actual Flowgate limit, and
- e. shadow price.

9 Overview of Coordinated Transaction Scheduling

Coordinated Transaction Scheduling or “CTS” are market rules implemented by MISO and PJM that allow real-time transactions to be scheduled based on a market participant’s willingness to purchase energy at a source (in the PJM Balancing Authority Area or the MISO Balancing Authority Area) and sell it at a sink (in the other Balancing Authority Area) if the forecasted price at the sink minus the forecasted price at the corresponding source is greater than or equal to the dollar value specified in the bid.

CTS transactions are ordinarily evaluated on a 15-minute basis consistent with forecasted real-time prices from MISO’s Coordinated Transaction Scheduling Dispatch run and the forecasted price information from PJM’s Intermediate Term Security Constrained Economic Dispatch solution. Coordinated optimization with CTS improves interregional scheduling efficiency by (i) better ensuring that scheduling decisions take into account relative price differences between the regions, and (ii) moving the evaluation of bids and offers closer to the time scheduling decisions are implemented.

MISO and PJM may suspend the scheduling of CTS transactions when MISO or PJM are not able to adequately implement schedules as expected due to: (1) a failure or outage of the data link between MISO and PJM prevents the exchange of accurate or timely data necessary to implement the CTS transactions; (2) a failure or outage of any computational or data systems preventing the actual or accurate calculation of data necessary to implement the CTS transactions; or (3) when necessary to ensure or preserve system reliability.

10 Market-to-Market Settlement Calculations for the Michigan-Ontario Phase Angle Regulators Interface

10.1 Qualification Test for MOPI M2M Flowgates

Unless both PJM and MISO agree otherwise, the Parties shall study each M2M Flowgate to determine whether the M2M Flowgate qualifies as a MOPI M2M Flowgate. A M2M Flowgate shall be considered a MOPI M2M Flowgate where the average MI-ONT PAR shift factor value is: (1) greater than or equal to 5 percent for a single-monitored element; (2) greater than or equal to 7.5 percent for a double-monitored element; or (3) greater than or equal to 10 percent for a triple-monitored element. A M2M Flowgate with more than three monitored elements may be added as a MOPI M2M Flowgate only upon mutual agreement by the Parties.

10.2 Market Flow and Firm Flow Entitlements Calculations on MOPI M2M Flowgates

In addition to the Market Flow and Firm Flow Entitlements calculated pursuant to Attachment 2 and the sections of Attachment 3 other than this Section 10, the Parties shall calculate separate MOPI Market Flows and MOPI Firm Flow Entitlements in accordance with Section 10.2.1 and 10.2.2, respectively, for each MOPI M2M Flowgate when the MI-ONT PARs are regulating (i.e., controlling loop flows with PAR tap changes) for Lake Erie circulation. The MOPI Market Flows and MOPI Firm Flow Entitlements calculated pursuant to Section 9.2.1 and 9.2.2 shall only be used only for the purpose of calculating market-to-market settlements on MOPI M2M Flowgates for periods when the MI-ONT PARs are regulating for Lake Erie circulation.

PJM and MISO shall use the Market Flow and Firm Flow Entitlements calculated pursuant to Attachment 2 to calculate market-to-market settlements when the MI-ONT PARs are not regulating for Lake Erie circulation.

10.2.1 MOPI Market Flow Calculations for MOPI Flowgates When MI-ONT PARs are Regulating

$$MOPI\ Market\ Flow_{MOPI\ M2M\ Flowgate\ X} = Market\ Flow_{MOPI\ M2M\ Flowgate\ X} + MI-ONT\ PARs\ Market\ Flow_{MOPI\ M2M\ Flowgate\ X} - LEC\ Adjustment_{MOPI\ M2M\ Flowgate\ X}$$

Where:

$Market\ Flow_{MOPI\ M2M\ Flowgate\ X}$ = the Market Flow for the relevant MOPI M2M Flowgate calculated in the same manner as M2M Flowgates, as described in Attachment 2 of this Agreement;

$MI\text{-}ONT\ PARs\ Market\ Flow_{MOPI\ M2M\ Flowgate\ X} = PAR\ Shift\ Factor_{MOPI\ M2M\ Flowgate\ X} \times$ the RTO's Market Flow for the four MI-ONT PAR paths, calculated in the same manner as the Market Flow is computed for M2M Flowgates, as described in Attachment 2 of this Agreement;

$PAR\ Shift\ Factor_{MOPI\ M2M\ Flowgate\ X}$ = the MI-ONT PAR interface shift factor on M2M Flowgate X;

$LEC\ Flow$ = The difference between the actual and scheduled flow on the MI-ONT PAR interface, with the clockwise flow around Lake Erie considered as the positive direction;

$LEC\ Bandwidth$ = a megawatt range agreed upon by the Parties that represents the maximum directional LEC Flow on the MI-ONT PAR interface, with the clockwise flow around Lake Erie considered as the positive direction; and

$LEC\ Adjustment_{MOPI\ M2M\ Flowgate\ X}$ = one of the following values:

- (1) where the LEC Flow is outside the LEC Bandwidth on the MI-ONT PAR interface, $LEC\ Adjustment_{MOPI\ M2M\ Flowgate\ X} = PAR\ Shift\ Factor_{MOPI\ M2M\ Flowgate\ X} \times (LEC\ Flow - LEC\ Bandwidth)$; or
- (2) where the actual circulation on the MI-ONT PAR interface is equal to or between the directional limits of the $LEC\ Bandwidth$, $LEC\ Adjustment_{MOPI\ M2M\ Flowgate\ X}$ shall equal zero.

10.2.2 MOPI Firm Flow Entitlement Calculations for MOPI Flowgates When MI-ONT PARs are Regulating

Firm Flow Entitlement for MOPI M2M Flowgates are calculated by: (1) revising the Flowgate contingency definition of the MOPI M2M Flowgate to include the MI-ONT PAR interface; and (2) calculating MOPI Firm Flow Entitlements for this MOPI M2M Flowgate in the same manner as all other M2M Flowgates with the following exception: impacts from historical reservations that cross the MI-ONT PAR interface shall be excluded from the process of calculating allocations described in Attachment 2 of this Agreement.

11 Market Flow Adjustment for Generator Pseudo-Ties

Pursuant to the calculations in this Section 11, the Parties shall adjust the Market Flow on M2M Flowgates for market-to-market settlement calculations to account for each generator pseudo-tied from PJM into MISO or pseudo-tied from MISO into PJM.

11.1 The Transfer Distribution Factor Calculation for each Generator Pseudo-Tie and Flowgate

The Parties shall use the equations in Section 11.1 to calculate the transfer distribution factor for each generator pseudo-tie and M2M flowgate pairing. The weighted shift factor for the MISO-PJM common interface definition will be determined based on a mutually agreed upon method and represents the portion of the path from the location of the pseudo-tied generator to the MISO-PJM border.

The Parties shall calculate a transfer distribution factor for each generator pseudo-tie and M2M Flowgate pairing. The calculation is as follows:

Where:

shift factor for each generator pseudo-tie and M2M Flowgate pairing

weighted shift factor for the MISO-PJM common interface and each M2M Flowgate pairing

11.2 The Generator Pseudo-Tie Market Flow Adjustment Calculation

The calculation for the Pseudo-Tie Market Flow Adjustment is the transfer distribution factor for each generator pseudo-tie and M2M Flowgate pairing multiplied by the output of the pseudo-tie and is described as follows:

Where:

transfer distribution factor for each generator pseudo-tie per flowgate

output per generator pseudo-tie based on net Market Flows serving Attaining BA load

Interregional Agreements --> MISO-JOA --> MISO-JOA ATTACHMENT 3 --> MISO-JOA Att 3 Section 11 Market Flow Adj for Gen Pseudo-Tie

The Parties shall sum each Pseudo-Tie Market Flow Adjustment for each generator pseudo-tie and M2M Flowgate pairing as follows:

$$\Sigma$$

Appendix A: Definitions

Any undefined, capitalized terms used in this ICP shall have the meaning: (i) provided in the Joint Operating Agreement between PJM and MISO, or in the CMP, or (ii) given under industry custom and, where applicable, in accordance with good utility practices.

Monitoring RTO	The RTO that has the primary responsibility for monitoring and control of a specified M2M Flowgate
Non-Monitoring RTO	The RTO that does not have the primary responsibility for monitoring and control of a specified M2M Flowgate, but does have generation that impacts that Flowgate
Firm Flow	The estimated impacts of firm Network and Point-to-Point service on a particular M2M Flowgate.
Firm Flow Entitlement	The firm flow entitlement (FFE) represents the net allocation on M2M Flowgates used in the market-to-market settlement process. The FFE is determined by taking the forward allocation (using 0% allocations) and reducing it by the lesser of the two day-ahead allocation in the reverse direction (using 0% allocations) or the generation-to-load impacts in the reverse direction (down to 0%). The generation-to-load impacts in the reverse direction come from the day-ahead allocation run. The forward allocation comes from the day-ahead network and native load (DA NNL) calculation. The FFE may be positive, negative or zero.
Flow Relief	The reduction in the MW flow on an M2M Flowgate that is caused by the generation redispatch as a result of the binding transmission constraint
Market Flow	The flow in MW on an M2M Flowgate that is caused by all generation deliveries to load in the RTO footprint.
Reciprocal Coordinated Flowgate (RCF)	A Coordinated Flowgate for which Reciprocal Entities have generation that has a GLDF on the flowgate at or above the NERC approved threshold (currently, 5% or greater)
Requesting RTO	RTO that is requesting an increase in their Firm Flow Entitlement in the Day-Ahead energy market coordination procedures. A Requesting RTO may be a Monitoring RTO or a Non-Monitoring RTO with respect to a given RCF in Real Time.
Responding RTO	RTO that is responding to a request to reduce their Firm Flow Entitlement in the Day-Ahead energy market coordination procedures. A Responding RTO may be a Monitoring RTO or a

	Non-Monitoring RTO with respect to a given RCF in Real Time.
UDS	Security constrained, economic dispatch software used to determine dispatch instructions to resources in a Party's market area.
M2M Flowgate	Has the definition as defined in Section 1 of this Attachment 3.
M2M Flowgate Studies	M2M Flowgate Studies consist of the coordinated flowgate tests defined in Section 3.2.1 of the Congestion Management Process and the significantly impacted flowgate tests defined in Section 1.1.3 of this Attachment 3.

ATTACHMENT 4

CROSS-BORDER GRANDFATHERED PROJECTS

Arrowhead – Gardner Park 345 kV Line

AEP 765 kV Cloverdale Line

ATTACHMENT 5

EMERGENCY ENERGY TRANSACTIONS

PJM or MISO may, from time to time, have insufficient Operating Reserves available to their respective systems, or need to supplement available resources to cover sudden and unforeseen circumstances such as loss of equipment or forecast errors. Such conditions could result in the need by the Party experiencing the deficiency to purchase Emergency Energy for Reliability reasons.

The purpose of this Attachment 5 is to allow for the exchange of Emergency Energy between the Parties during such times when resources are insufficient and commercial remedies are not available. The offer to provide Emergency Energy shall be available only when the Party experiencing the deficiency has declared an Energy Emergency Alert, Level Alert 2, as defined in Attachment 1 of NERC Standard EOP-002-0, or as defined in a subsequent revision of such Standard.

1.0: CHARACTERISTICS OF THE POWER AND ENERGY

Unless otherwise mutually agreed, all power and energy made available by the delivering Party shall be three phase, 60 Hz alternating current at operating voltages established at the Delivery Point in accordance with system requirements and appropriate to the Interconnection.

2.0: NATURE OF SERVICE

2.1 PJM, to the maximum extent it deems consistent with:

- (a) the safe and proper operation of its own system,
- (b) the furnishing of dependable and satisfactory services to its own customers, and
- (c) its obligations to other parties,

shall make available to MISO energy market Emergency Energy from available generating capability in excess of its load requirements up to the transfer limits in use between the two Balancing Authority Areas.

PJM shall refer to all Emergency Energy transactions as being sold:

- (a) “Recallable” where such a delivery could reasonably be expected to be recalled if PJM needed the generation for a deployment of reserves or other system Emergency; or
- (b) “Non-Recallable” where PJM would normally be able to continue delivering the Emergency Energy following a reserve deployment.

The Parties shall use reasonable efforts to ensure that an Emergency Energy transaction continues only until it can be replaced by a commercial transaction.

2.2 MISO, to the maximum extent it deems consistent with:

- (a) the safe and proper operation of its own Transmission System,
- (b) the furnishing of dependable and satisfactory services to its own customers, and
- (c) its obligations to other parties, including the terms and conditions of the Midwest ISO Tariff.

shall make available to PJM Emergency Energy from available generating capability in excess of its load requirements up to the transfer limits in use between the two Balancing Authority Areas.

MISO shall refer to all Emergency Energy transactions as being sold:

- (a) “Recallable” where such a delivery could reasonably be expected to be recalled if MISO needed the generation for a deployment of reserves or other system Emergency; or
- (b) “Non-Recallable” where MISO would normally be able to continue delivering the Emergency Energy following a reserve deployment.

The Parties shall use reasonable efforts to ensure that an Emergency Energy transaction continues only until it can be replaced by a commercial transaction.

2.3 In the event one Party is unable to provide Emergency Energy to the other Party when needed, but there is energy available from a third party Balancing Authority, delivery of such Emergency Energy will be facilitated to the extent feasible.

2.4 MISO does not take title to energy, or Emergency Energy, under its tariff but will purchase or sell such energy for and on behalf of, its Market Participants and will invoice and make payment to PJM, as set forth in the Joint Operating Agreement.

3.0: RATES AND CHARGES

- 3.1 All Emergency Energy transactions shall be billed based on scheduled deliveries.
- 3.2 All rates and charges associated with Emergency Energy shall be expressed in funds of the United States of America.
- 3.3 MISO and PJM agree that the charge for Emergency Energy delivered by one Party to the other Party shall be as defined below.

The delivering Party shall be allowed to include, in the total price charged for Emergency Energy, all costs incurred in the delivery of Emergency Energy to the Delivery Point, and the receiving Party shall be responsible for all costs at and beyond the Delivery Point.

Direct Transaction

The charge for Emergency Energy supplied by delivering Party in any hour to the receiving Party shall be calculated using the following two-part formula. The first part of the formula calculates the energy portion of the charge and the second part incorporates any transmission charges incurred by the delivering Party to deliver the Emergency Energy to the Delivery Point. In the case of PJM as the delivering Party, the cost of the energy portion shall be the greater of 150% of any applicable Locational Marginal Price ("LMP") at the point(s) of delivery to provide the Emergency Energy, or \$100/MWHR. In the case of MISO as the delivering Party, the cost of the energy portion shall be the greater of 150% of the LMP at the point(s) of exit at the bus or buses at the border of the delivering Party's market, or \$100/MWHR.

Energy Portion for an hour =

*(Emergency Energy supplied in the hour in MWHr) times
(delivering Party's cost of such energy in \$/MWHr)*

Transmission Charge to Delivery Point (if applicable) =

The actual ancillary services (including delivering Party's market charges applicable to export schedules) and transmission costs incurred by the delivering Party in delivering such Emergency Energy to the Delivery Point pursuant to the delivering Party's Tariff or the equivalent thereof, including costs incurred pursuant to the transmission tariff of any transmission service provider in the event that a Party's Market Flows exceed the physical capability in megawatts of the contract path between two of its regions to serve its load.

Total Charge for Emergency Energy supplied in any hour =

The sum of the Energy Portion for an hour and the Transmission Charge for that same hour.

A Party requesting Emergency Energy under this Section is obligated to pay for the Emergency Energy in the amount requested, times a minimum period of one clock hour, once the delivering Party has initiated the redispatch of generation in the delivering Party's energy market or dispatch order, so that the energy will be made available at the time requested to the receiving Party at the Delivery Point.

Transaction from Third Party Supplier

The charge for Emergency Energy supplied to the receiving Party from a third party through the delivering Party's system shall be calculated using the following two-part formula. The first part of the formula calculates the energy portion of the charge and the second part incorporates any transmission charges incurred by the delivering Party to deliver the Emergency Energy to the Delivery Point. The delivering Party's cost for Emergency Energy shall be the cost that the third-party supplier charges the delivering Party or as otherwise stated in an agreement between receiving Party and the third-party supplier.

Energy Portion for an hour =

*(Emergency Energy supplied in the hour in MWhr) times
(Third-party Supplier's charge for such energy in \$/MWhr)*

Transmission Charge to Delivery Point (if applicable) =

The actual ancillary service costs (as applicable), transmission costs and all other applicable costs attributable to such transactions incurred by the delivering Party in delivering such energy to the Delivery Point pursuant to the delivering Party's Tariff or the equivalent thereof, including costs incurred pursuant to the transmission tariff of any transmission service provider in the event that a Party's Market Flows exceed the physical capability in megawatts of the contract path between two of its regions to serve its load.

Total Charge for Emergency Energy supplied in an hour =

The sum of the energy portion for an hour and the transmission charge for that same hour.

A Party requesting Emergency Energy under this Attachment 5 is obligated to pay the Transmission Charge, times a minimum period of one clock hour, once the delivering Party has entered the necessary schedules in the delivering Party's system.

4.0: MEASUREMENT OF ENERGY INTERCHANGED

All Emergency Energy supplied at the Delivery Point shall be metered. The delivering Party shall be responsible for the actual losses as a result of delivery to the delivery Point and the receiving Party shall be responsible for all losses from the delivery Point.

5.0: BILLING AND PAYMENT

5.1 Billing for, and payment of, all charges incurred pursuant to this Attachment 5 shall be pursuant to Section 16.2 of the Joint Operating Agreement of which this Attachment is a part.