

# Configuration Outage Reporting

Troy Cawley  
Sr. Engineer, Real-Time Market Operations  
Modelling Generation Senior Task Force  
January 26, 2018

# 2 x 1 Combined Cycle (physical model)

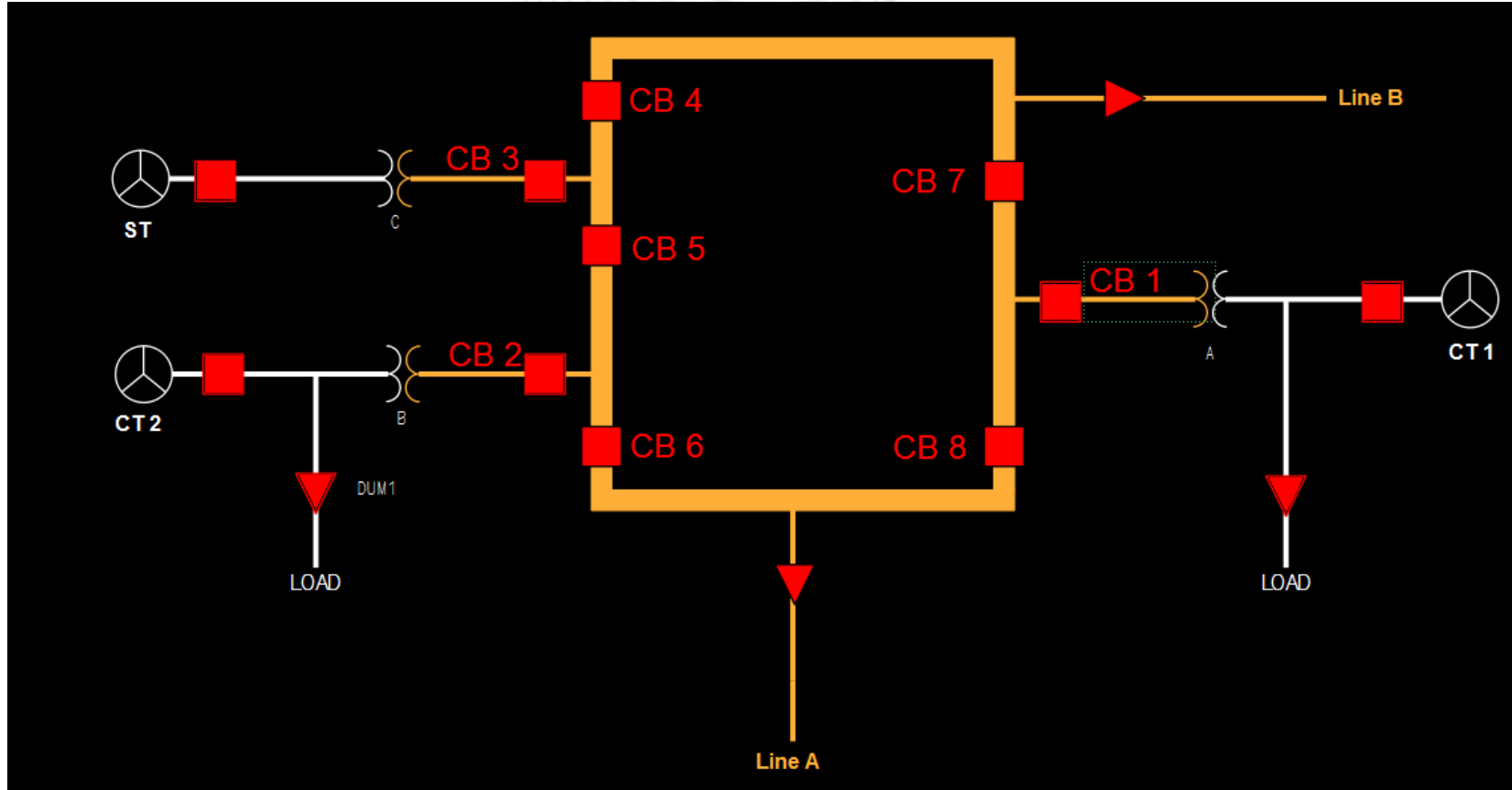

**pjm** | Markets Gateway

Market Day: 1/22/2018 | Portfolio: [ ] | Location: [ ]

Refresh [XML] | Save [CSV]

Hourly Updates | Detail | Energy Ramp Rates | Synchronized Reserve Ramp Rates | Wind Forecast | Solar Forecast | IntraDay Opt Out

Last Updated Date/Time: 2018-01-19 11:16:29

Hour	Emer. Min. (Default)	Emer. Min. (MW)	Econ. Min. (Default)	Econ. Min. (MW)	CIR	Econ. Max. (Default)	Econ. Max. (MW)	Emer. Max. (Default)	Emer. Max. (MW)	Commit Status	Fixed Gen.?
1											
2											
3											
4											
5											
6											
7											
8											
9											
10											
11											
12											
13											
14											

Unit

Unit Eco Min/Max are updated in real-time to reflect the current configuration.

The screenshot shows the PJM Markets Gateway interface. On the left is a navigation menu with categories like Bilaterals, Con Edison, Demand, Demand Response, Generator, Unit, Schedules, Dispatch Lambda, Market Results, Regulation Market, Synchronized Reserve Mar, Day-Ahead Scheduling Res, Interface Pricing, Opportunity Cost Calculator, Parameter Limits, Price Responsive Demand, Public, System Utilities, Up-To-Transaction, Virtual, and Weather Forecast. The 'Schedules' item is highlighted with a red box. The main content area has a header with 'Markets Gateway' and a search bar. Below the header are filters for Market Day (1/22/2018), Portfolio, Location, and Schedule (99). There are 'Refresh' and 'Save' buttons with XML and CSV icons. A row of tabs includes 'Offers', 'Offer Updates', 'Detail', 'Detail Updates', 'Manager', 'Selection', 'Availability Update', 'Restriction Information', and 'TPS Schedule Switch'. The 'Offers' tab is active and highlighted with a red box. A checkbox labeled 'Use Offer Slope' is checked and circled in red. Below the tabs is a table with two columns: 'MW' and 'Price', both circled in red. A red arrow points from the 'MW' column to a text box at the bottom. The text box contains two lines of red text: 'Schedule offers are input as Price-MW pairs on a per-schedule basis.' and 'Unit eco min/max adjustments attempt to approximate the unit's cost curve for the current operating range (for all configurations).'

## Unit-Based

MW	Price
0	\$19.00
315	\$19.01
390	\$19.50
465	\$20.50
535	\$21.70
536	\$34.90
590	\$35.00

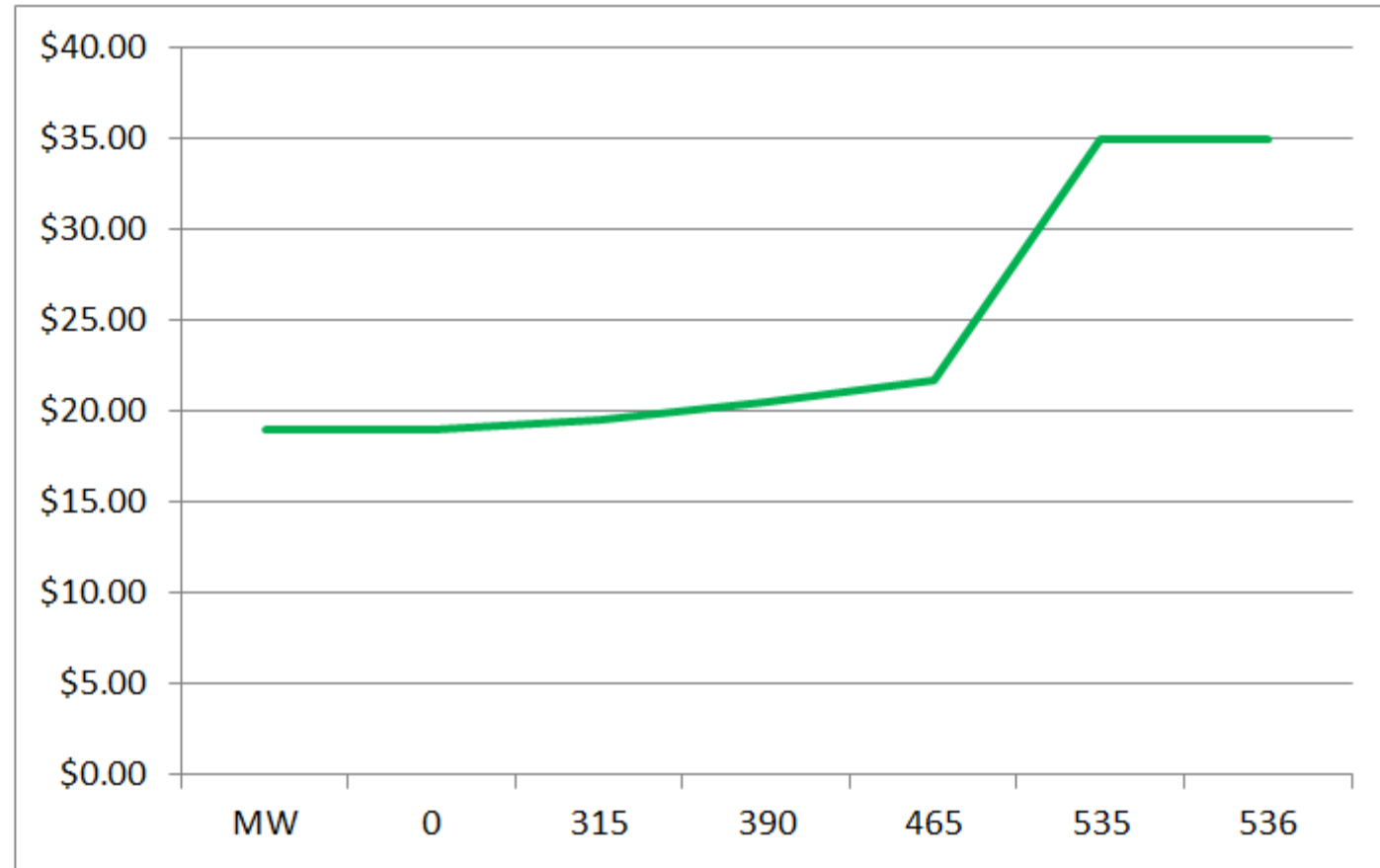

## Unit-Based

MW	Price
0	\$19.00
315	\$19.01
390	\$19.50
465	\$20.50
535	\$21.70
536	\$34.90
590	\$35.00

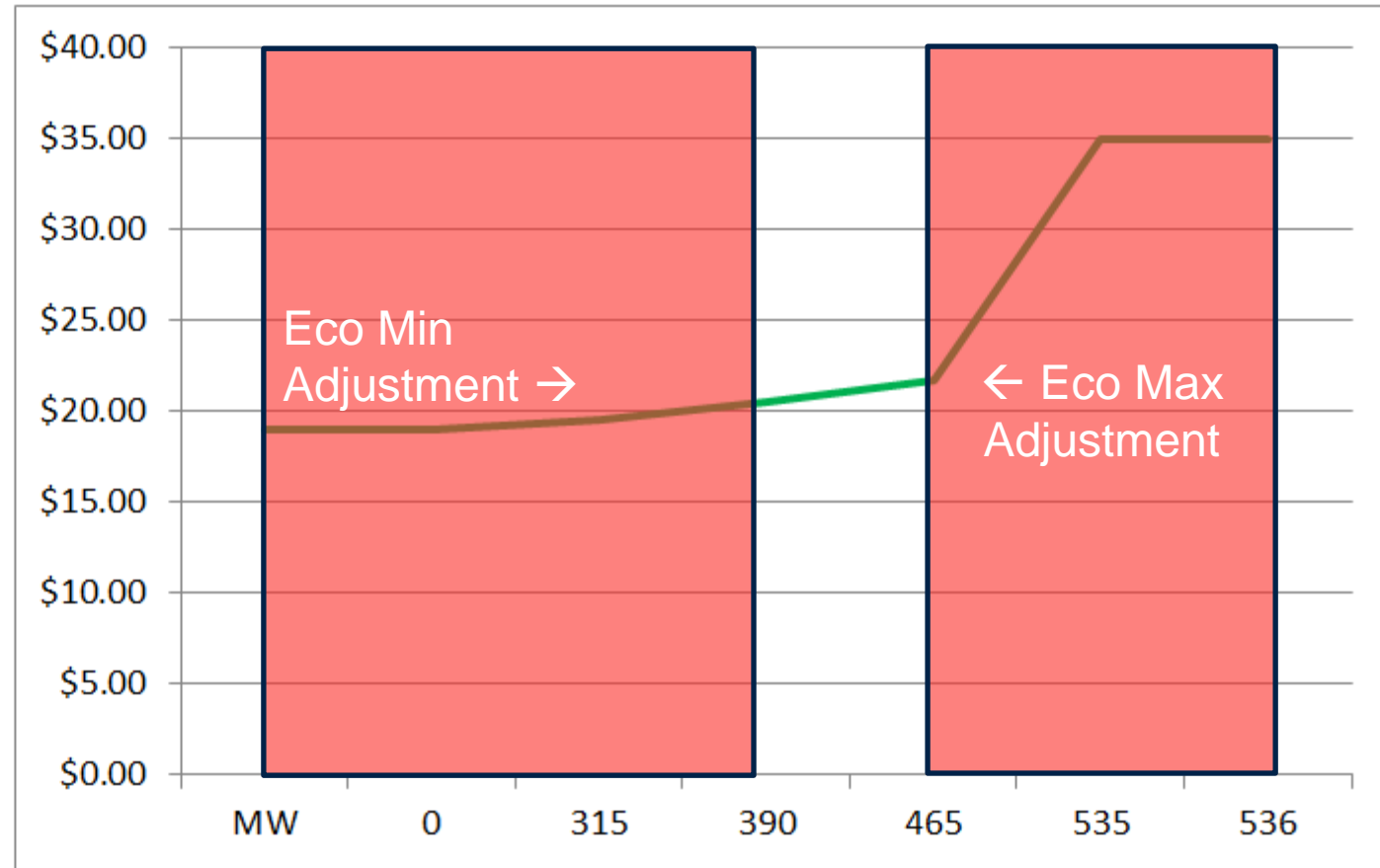

## Unit Model

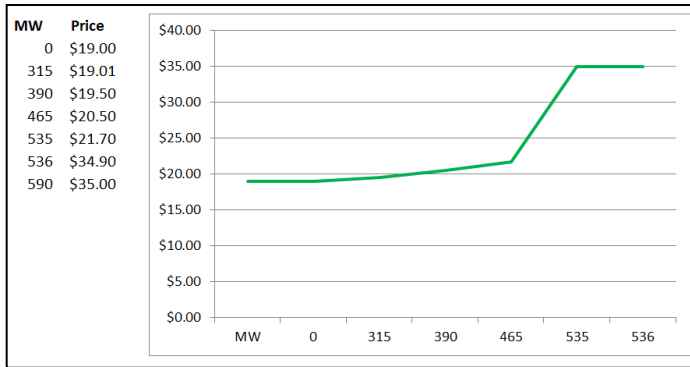

1x0 MW	1x0 Price
0	\$19.00
315	\$19.01

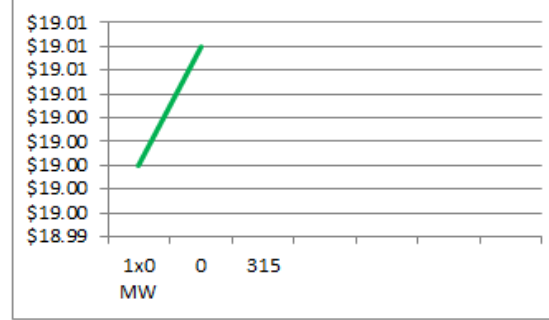

1x1 MW	1x1 Price
315	\$19.01
390	\$19.50
465	\$20.50

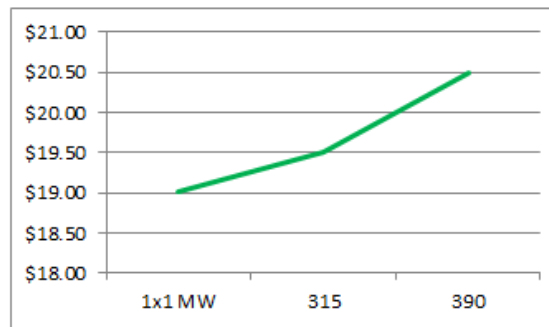

2x0 MW	2x0 Price
390	\$19.50
465	\$20.50

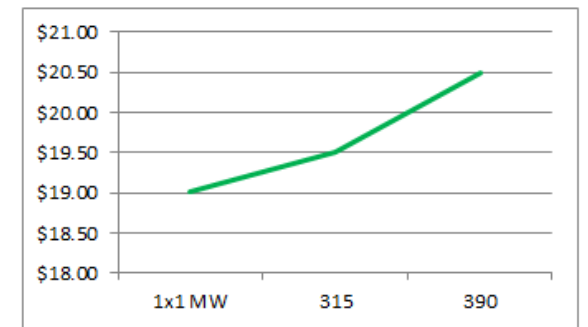

2x1 MW	2x1 Price
390	\$19.50
465	\$20.50
535	\$21.70
536	\$34.90
590	\$35.00

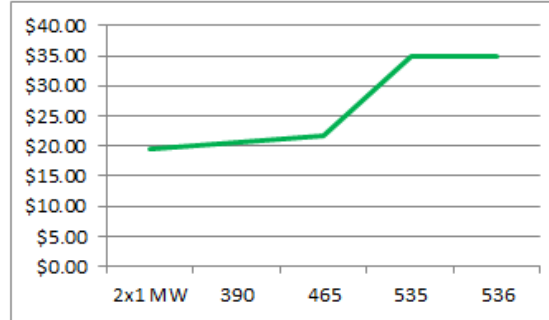

1x0 MW	1x0 Price
0	\$19.00
315	\$19.01

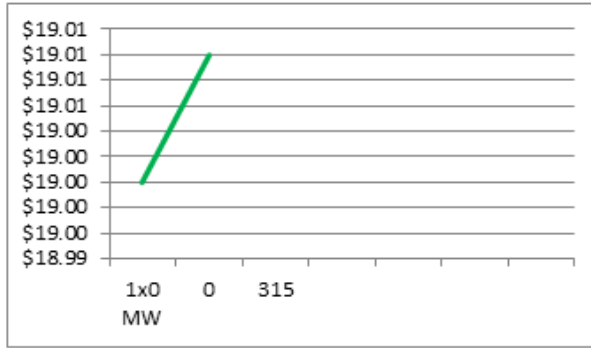

## Example: HRSG Outage

1x1 MW	1x1 Price
315	\$19.01
390	\$19.50
465	\$20.50

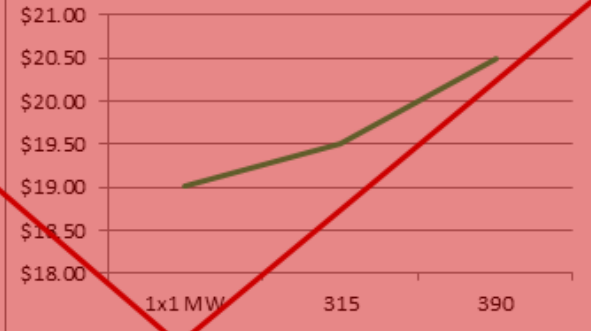

2x0 MW	2x0 Price
390	\$19.50
465	\$20.50

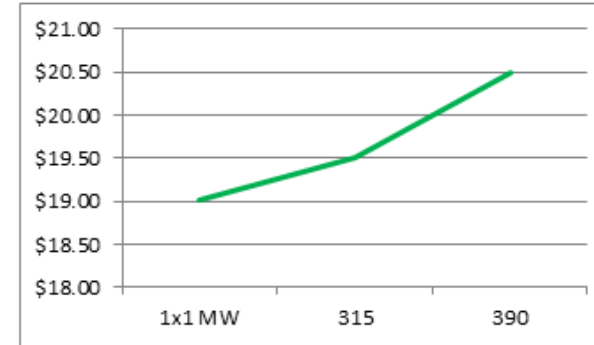

2x1 MW	2x1 Price
390	\$19.50
465	\$20.50
535	\$21.70
536	\$34.90
590	\$35.00

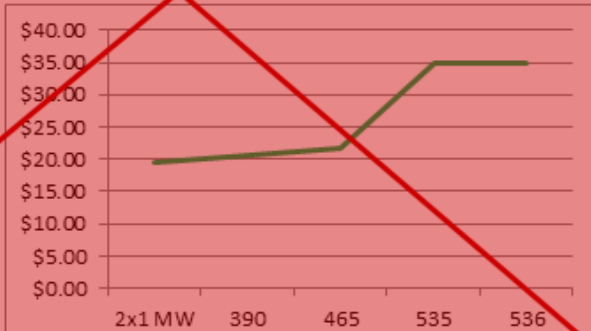



**1x0 MW 1x0 Price**  
 0 \$19.00  
 315 \$19.01

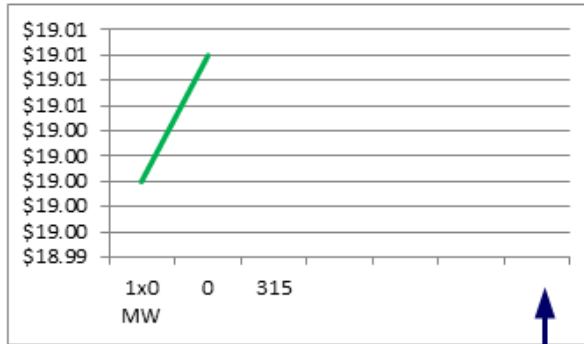

**1x1 MW 1x1 Price**  
 315 \$19.01  
 390 \$19.50  
 465 \$20.50

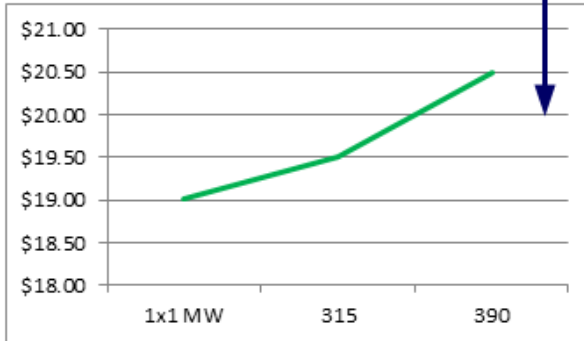

## Example: CT Outage



~~**2x1 MW 2x1 Price**  
 390 \$19.50  
 465 \$20.50  
 535 \$21.70  
 536 \$34.90  
 590 \$35.00~~

