

# Submission of Supplemental Projects for Inclusion in the Local Plan

# Note

- Supplemental projects with a Local Plan submission date of 02/21/2024 will be modeled in the 2024 Series RTEP.

# Initially posted to 2021 Local Plan for s2340.1 & s2340.2

Updates to s2340.1 & s2340.2 for 2024 Local Plan highlighted in red below

# Dominion Transmission Zone M-3 Process Do No Harm (DNH) Analysis

**Need Number:** DOM-2020-0026-DNH (Rollins Ford)

**Process Stage:**

Submission of Supplemental Project for Inclusion in the Local Plan – 02/21/2024

**Previously Presented:**

Solution – 06/08/2021; 02/07/2023

**Project Driver:**

Do No Harm Analysis

**Problem Statement:**

PJM has identified a N-1 Generator Deliverability contingency that results in an overload of both segments of Line 2114 (Remington CT to Elk Run; Elk Run to Rollins Ford) during the 2021 Do-No-Harm analysis.

For example, the loss of Line 569 (Loudoun – Morrisville) under contingency DVP-P1-2: LN 569 creates overloads of:

- Line 2114 (Remington CT to Elk Run) – Current rating 1047 MVA
- Line 2114 (Elk Run to Rollins Ford) – Current rating 1047 MVA

The violations are caused by previously presented Supplemental Project DOM-2020-0026 in the Dominion Zone.

**Updated Criteria Evaluation:**

PJM had also identified overlapping thermal violations in the 2026 Summer RTEP model from Remington CT to Gainesville. The reconductor portion of the previously proposed supplemental solution was submitted and approved as a part of the PJM 2021 Reliability Open Window #1 (b3689.1).

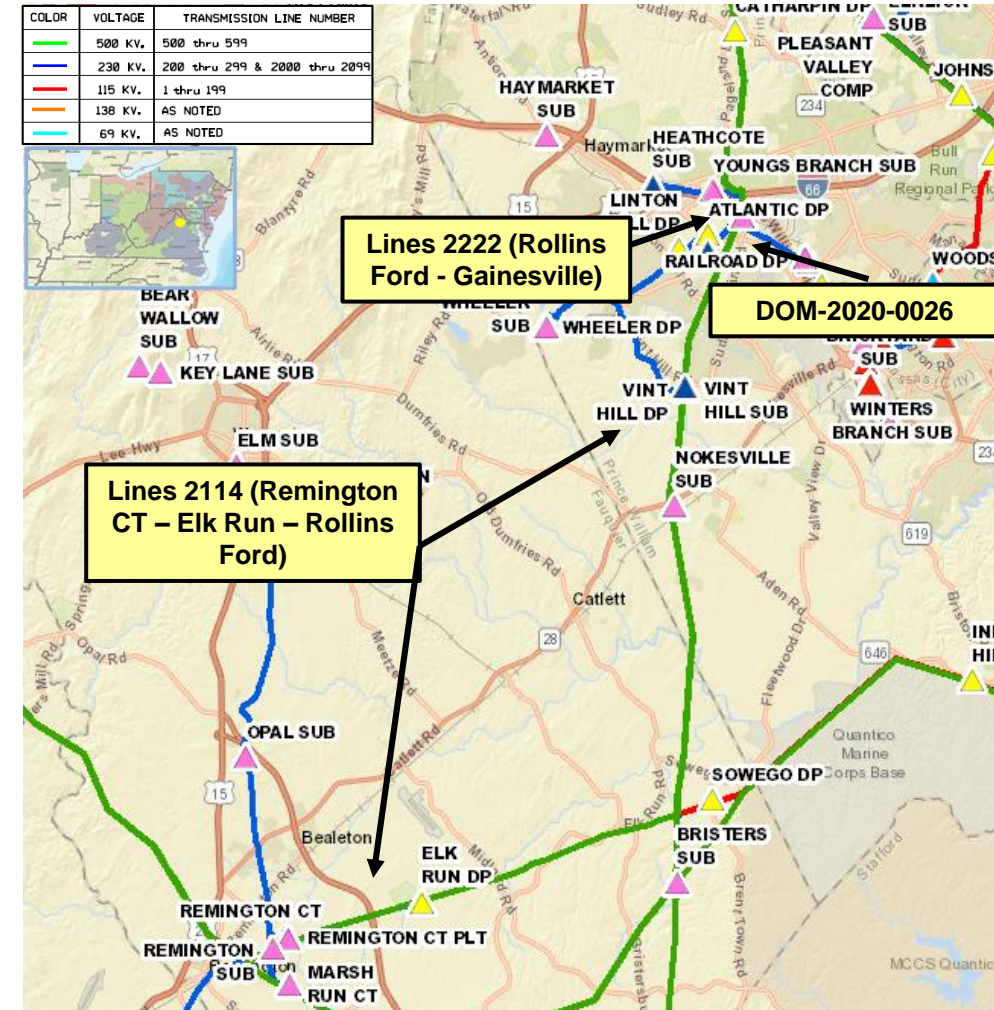

**Initially posted to 2021 Local Plan for s2340.1 & s2340.2**

**Updates to s2340.1 & s2340.2 for 2024 Local Plan highlighted in red below**

Dominion Transmission Zone M-3 Process  
Do No Harm (DNH) Analysis

**Previous Solution (Approved as baseline b3689.1):**

**Solution Approved as Baseline b3689.1:**

Re-conductor the segments of 230kV Line 2114 from Remington CT to Elk Run (approx. 3.46 miles) and Elk Run to Rollins Ford (approx. 19.71 miles) using a higher capacity conductor to achieve an expected rating of 1573 MVA.

Re-conductor approx. 1.11 miles of 230kV Line 2222 from Rollins Ford to Gainesville using a higher capacity conductor to achieve an expected rating of 1573 MVA.

**Proposed Solution:**

At Remington CT, upgrade (2) 230 kV circuit breakers and terminal equipment (switches, leads, etc.) to 4000 A 230 kV standards.

At Gainesville, upgrade (2) 230 kV circuit breakers and terminal equipment (switches, leads, etc.) to 4000 A 230 kV standards.

**Estimated Cost:**

At Remington CT (s2340.1) - **\$1.5M** (Previously \$35.0M for Line #2114)

At Gainesville (s2340.2) - **\$8.0M** (Previously \$2.0M for Line #2222)

**Projected In-service Date:** 12/31/2026 (Previously 12/31/2025)

**Project Status:** Conceptual

**Model:** 2025 RTEP

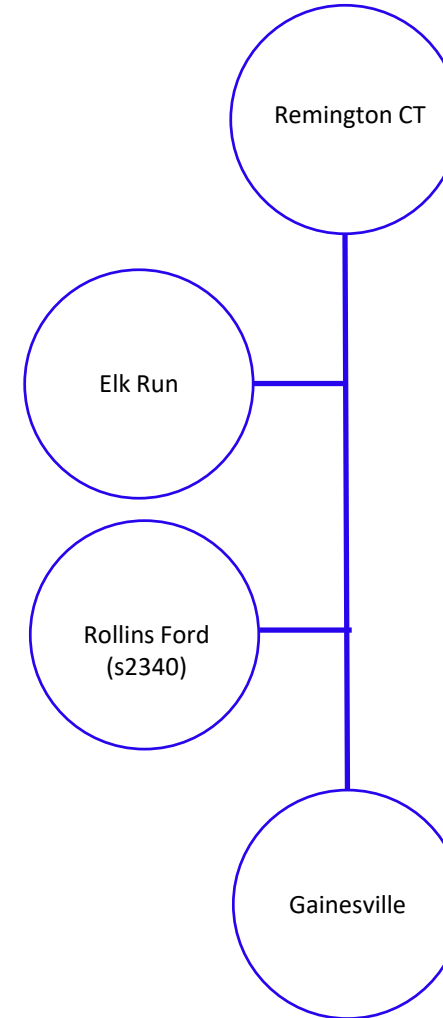

**Initially posted to 2021 Local Plan for s2499**  
**Updates to s2499 for 2024 Local Plan highlighted in red below**

**Need Number:** DOM-2020-0036

**Process Stage:**

Submission of Supplemental Project for Inclusion in the Local Plan – 02/21/2024

**Previously Presented:**

Need – 10/06/2020

Solution – 11/04/2020; 07/12/2022

**Project Driver:**

Equipment Material Condition, Performance, and Risk

**Specific Assumption Reference:**

See details on Dominion Energy’s End of Life Criteria in Dominion’s Planning Assumptions presented in December 2019 and updated in June 2020.

**Problem Statement:**

Dominion Energy has identified a need to replace 60 concrete structures of Line #2007 (Lynnhaven – Thalia) based on the Company’s End of Life criteria.

- The 3.37 miles long line was constructed on concrete structures in 1970. These structures have developed significant structural concerns as they age.
- Every pole is experiencing hairline cracking at a minimum, and many of the poles have more advanced cracking that has exposed some of the interior reinforcing bars and cables.
- The cracks allow for significant water infiltration which can accelerate the deterioration of the concrete and cause rusting of the steel reinforcing components.
- The Line #2007 provides service to Thalia substation with approximately 134 MW of tapped load.
- **Dominion Energy acquired rights to use the existing right-of-way corridor containing Line #2007 which are nearing expiration.**

Dominion Transmission Zone M-3 Process  
 230 kV Line #2007 – EOL Rebuild

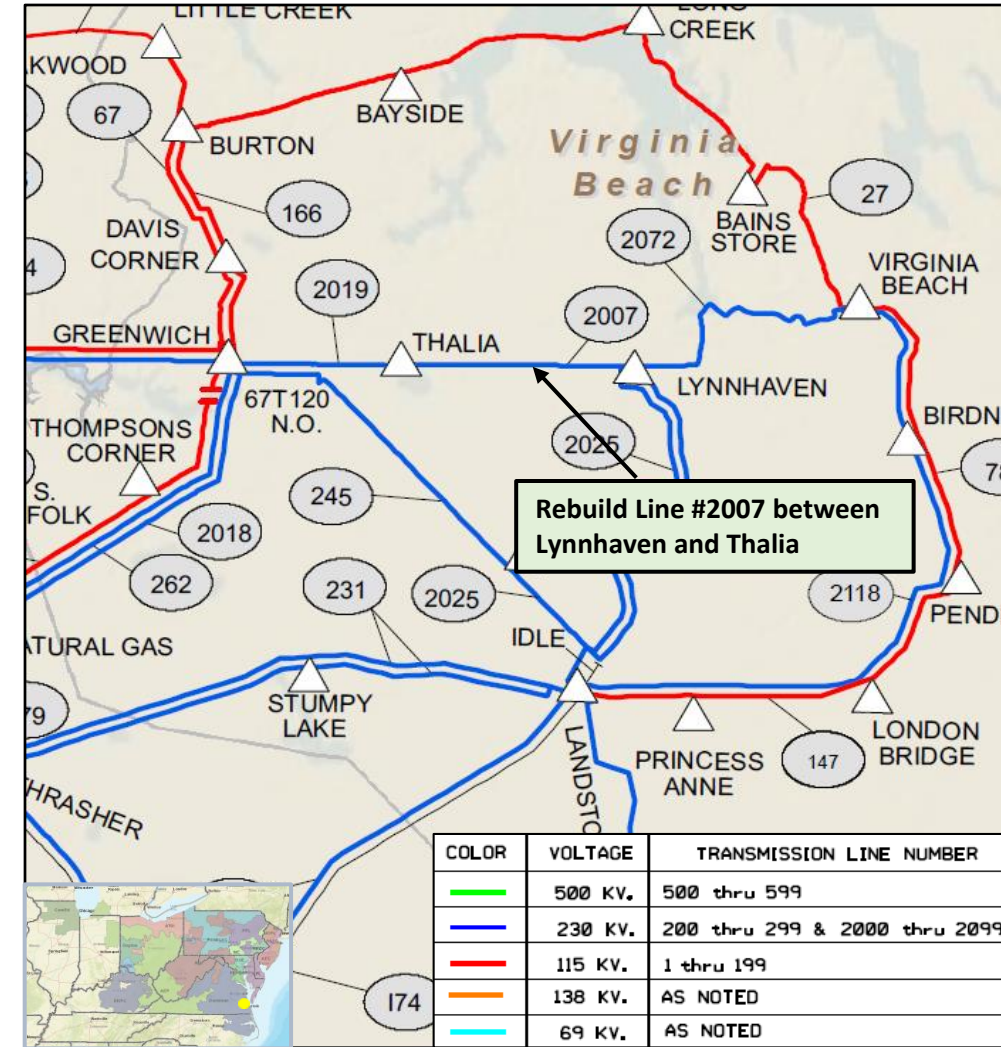

**Initially posted to 2021 Local Plan for s2499**  
**Updates to s2499 for 2024 Local Plan highlighted in red below**

Dominion Transmission Zone M-3 Process  
230 kV Line #2007 – EOL Rebuild

**Need Number:** DOM-2020-0036

**Process Stage:**

Submission of Supplemental Project for Inclusion in the Local Plan – 02/21/2024

**Selected Solution:**

Rebuild the 3.37 miles long Line #2007 between Lynnhaven and Thalia to current 230kV standards. The normal summer rating of the line conductor will be ~~1047~~ **1573** MVA. **Dominion Energy to pursue with the City of Virginia Beach extending the rights for use of the existing Line #2007 corridor.**

**Estimated Cost:** ~~\$7.0~~ **\$28.7** M

**Projected In-Service:** 12/31/2025

**Supplemental Project ID:** s2499

**Project Status:** Conceptual

**Model:** 2025 RTEP

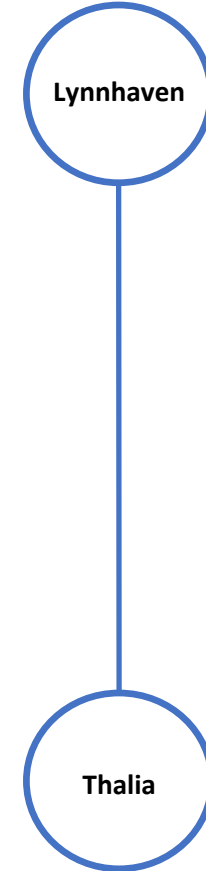

## Initially posted to 2021 Local Plan for s2500

## Updates to s2500 for 2024 Local Plan highlighted in red below

**Need Number:** DOM-2020-0037

**Process Stage:**

Submission of Supplemental Project for Inclusion in the Local Plan – 02/21/2024

**Previously Presented:**

Need – 10/06/2020

Solution – 11/04/2020; 07/12/2022

**Project Driver:**

Equipment Material Condition, Performance, and Risk

**Specific Assumption Reference:**

See details on Dominion Energy’s End of Life Criteria in Dominion’s Planning Assumptions presented in December 2019 and updated in June 2020.

**Problem Statement:**

Dominion Energy has identified a need to replace 20 concrete structures (Structure 2019/21 – Thalia segment) of Line #2019 (Greenwich – Thalia) based on the Company’s End of Life criteria.

- The 1.17 miles segment of Line #2019 was constructed on concrete structures in 1970. These structures have developed significant structural concerns as they age.
- Every pole is experiencing hairline cracking at a minimum, and many of the poles have more advanced cracking that has exposed some of the interior reinforcing bars and cables.
- The cracks allow for significant water infiltration which can accelerate the deterioration of the concrete and cause rusting of the steel reinforcing components.
- The Line #2019 provides service to Thalia substation with approximately 134 MW of tapped load.
- **Dominion Energy acquired rights to use the existing right-of-way corridor containing Line #2019 which are nearing expiration.**

## Dominion Transmission Zone M-3 Process 230 kV Partial Line #2019 – EOL Rebuild

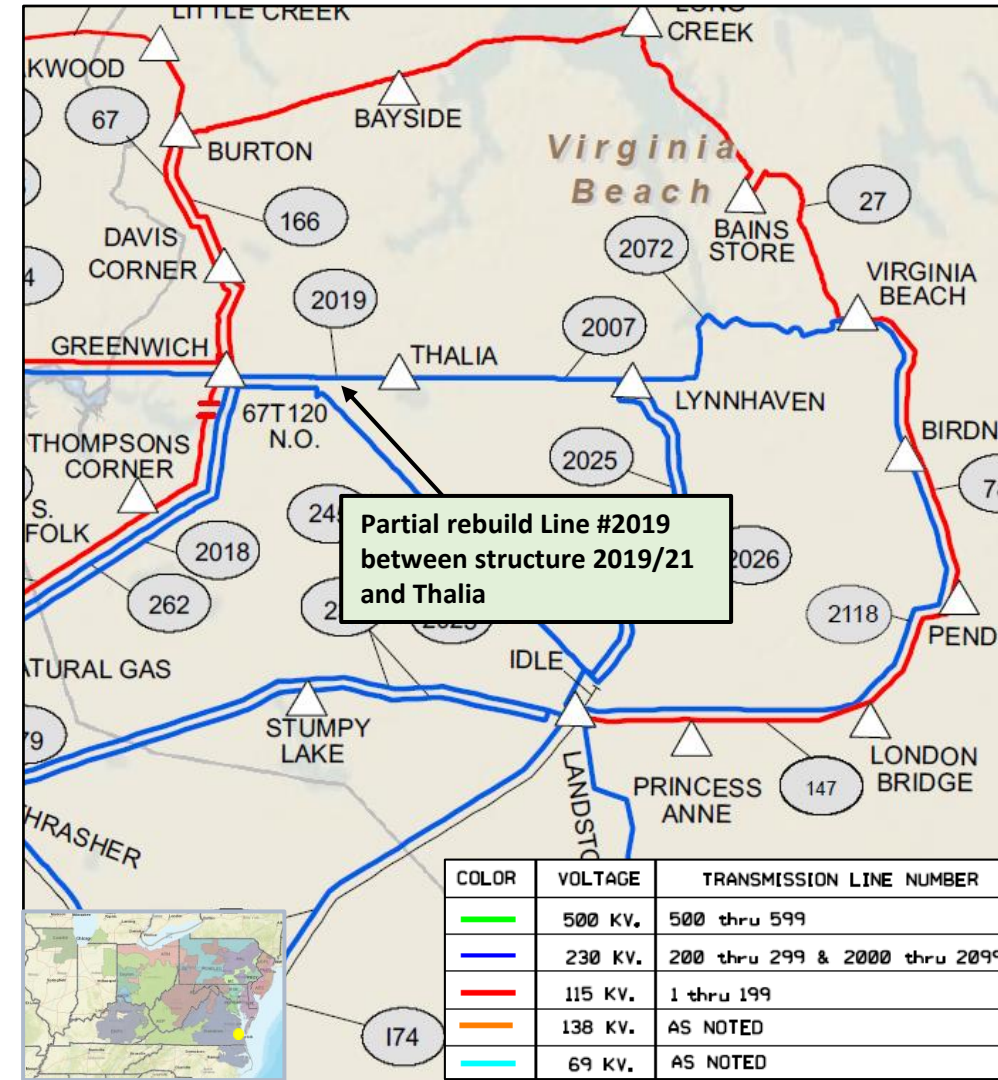

**Initially posted to 2021 Local Plan for s2500**  
**Updates to s2500 for 2024 Local Plan highlighted in red below**

Dominion Transmission Zone M-3 Process  
230 kV Partial Line #2019 – EOL Rebuild

**Need Number:** DOM-2020-0037

**Process Stage:**

Submission of Supplemental Project for Inclusion in the Local Plan – 02/21/2024

**Selected Solution:**

Rebuild approximately 1.17 miles of Line #2019 between Thalia and Structure 2019/21 to current 230kV standards. The normal summer rating of the line segment will be ~~1047~~ **1573** MVA. **Dominion Energy to pursue with the City of Virginia Beach extending the rights for use of the existing Line #2019 corridor.**

**Estimated Cost:** ~~\$3.0~~ **\$14.3** M

**Projected In-Service:** ~~12/15/2025~~ **12/31/2025**

**Supplemental Project ID:** s2500

**Project Status:** Conceptual

**Model:** 2025 RTEP

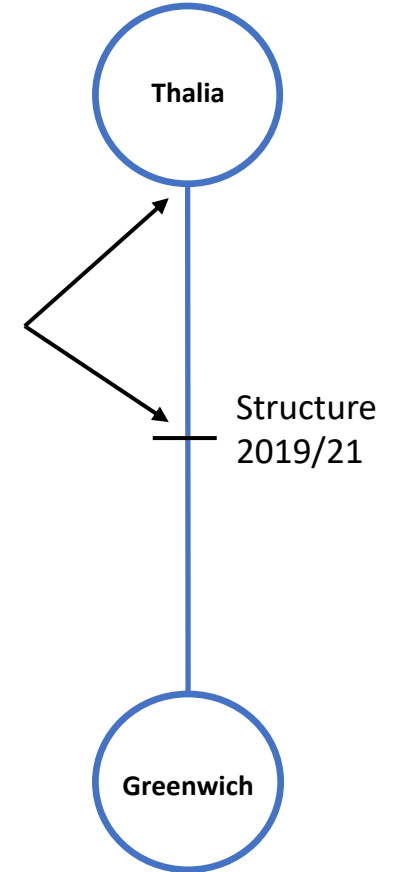



## Initially posted to 2021 Local Plan for s2609.2

## Updates to s2609.2 for 2024 Local Plan highlighted in red below

Need Number: DOM-2021-0016-DNH

### Process Stage:

Submission of Supplemental Project for Inclusion in the Local Plan – 02/21/2024

### Pleasant View 500-230kV Transformer (s2609.2)

- Install (1) 4440 **840** MVA 500-230 kV transformer at Goose Creek Substation.
  - Extend the existing 500kV ring bus at Goose Creek Substation to be set up for a future six-breaker ring arrangement. One breaker to be installed initially creating a five-breaker ring bus.
  - Install a new 230kV ring bus at Goose Creek Substation to be set up for a future four-breaker ring arrangement. Three 230kV breakers to be installed initially.
- Cut and extend line #227 (Belmont to Beaumeade) into Goose Creek Substation.

**Estimated Project Cost:** \$40.0 M

Transmission Line Cost: \$5.0 M

Substation Cost: \$35 M

### Alternatives Considered:

No feasible alternatives

**Projected In-service Date:** ~~12/15/2026~~ **12/15/2023**

**Project Status:** In-Service

**Model:** 2025 RTEP

### Reason for change:

- Inability to procure 1440 MVA transformer to address real-time operational constraints.
- Provide operational flexibility for securely operating the system under various outage scenarios.

# Dominion Transmission Zone: Supplemental Do No Harm Analysis

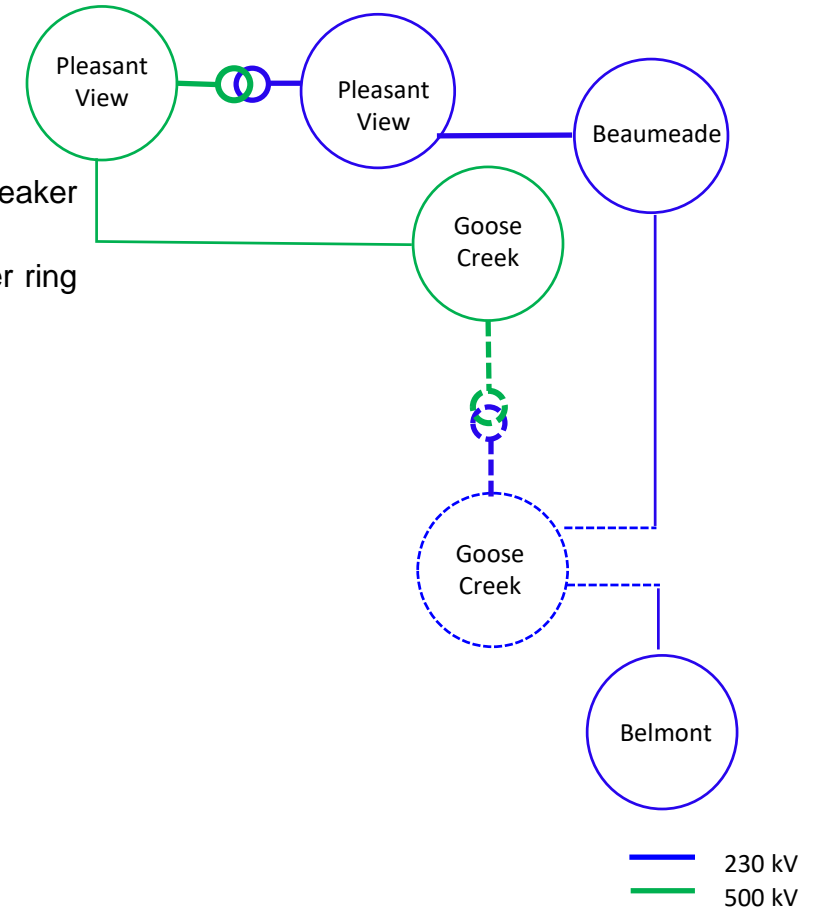

**Initially posted to 2021 Local Plan for s2620**  
**Updates to s2620 for 2024 Local Plan highlighted in red below**

**Need Number:** DOM-2021-0018

**Process Stage:**

Submission of Supplemental Project for Inclusion in the Local Plan – 02/21/2024

**Previously Presented:**

Need – 04/06/2020

Solution – 05/11/2021

Project Cancelled at 09/06/2022 TEAC Meeting

**Project Driver:**

Customer Service

**Specific Assumption Reference:**

Customer load request will be evaluated per Dominion’s Facility Interconnection Requirements Document and Dominion’s Transmission Planning Criteria.

**Problem Statement:**

DEV Distribution has submitted a DP Request to add a 2<sup>nd</sup> distribution transformer at Nokesville Substation in Prince William County. The new transformer is being driven by continued load growth in the area.

Projected 2026 load

Summer: 63.3 MW

Winter: 58.8 MW

Dominion Transmission Zone M-3 Process  
 Nokesville - Add 2<sup>nd</sup> TX - DEV



**Initially posted to 2021 Local Plan for s2620**  
**Updates to s2620 for 2024 Local Plan highlighted in red below**

Dominion Transmission Zone M-3 Process  
Nokesville - Add 2<sup>nd</sup> TX - DEV

**Need Number:** DOM-2021-0018

**Process Stage:**

Submission of Supplemental Project for Inclusion in the Local Plan – 02/21/2024

Project Cancelled at 09/06/2022 TEAC Meeting

**Selected Solution:**

Install a 1200 Amp, 50kAIC circuit switcher and associated equipment (bus, relaying, etc.) to feed the new transformer at Nokesville.

**Estimated Cost:** \$0.75 M

**Projected In-Service:** 11/01/2022

**Supplemental Project ID:** s2620

**Project Status:** Engineering

**Model:** 2025 RTEP

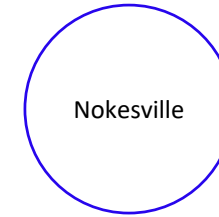

**Initially posted to 2023 Local Plan**  
**Updates for 2024 Local Plan highlighted in red on next slide**

# Dominion Transmission Zone: Supplemental Equipment Material Condition, Performance and Risk

**Need Number:** DOM-2021-0047

**Process Stage:** Solution Meeting 08/08/2023

**Previously Presented:** Solution Meeting 08/09/2022, Need Meeting 06/08/2021

**Project Driver:** Equipment Material Condition, Performance and Risk

**Specific Assumption References:**

See details on Equipment Material Condition, Performance and Risk in Dominion’s Planning Assumptions presented in December 2020.

**Problem Statement:**

Dominion Energy has identified a need to replace approximately 0.73 miles of 230kV Line #2167 (Hathaway to Edgecombe NUG), and 16.9 miles of 230kV Line #229 (Tarboro to Edgecombe NUG) which includes 2.1-mile segments of double circuit with Line #55 (Tarboro to Anaconda) and 0.95 miles single circuit segments of Line #55 based on the Company’s End of Life criteria.

- Double-circuit is on steel towers and single-circuit is on 2-pole wood H-frame structures all dating back to 1967. Conductor is ACSR.
- A field-condition assessment indicated woodpecker damage and broken insulators.
- Industry guidelines indicate equipment life for steel structures is 40-60 years, wood structures 35-55 years, conductor and connectors are 40-60 years, and porcelain insulators are 50 years.

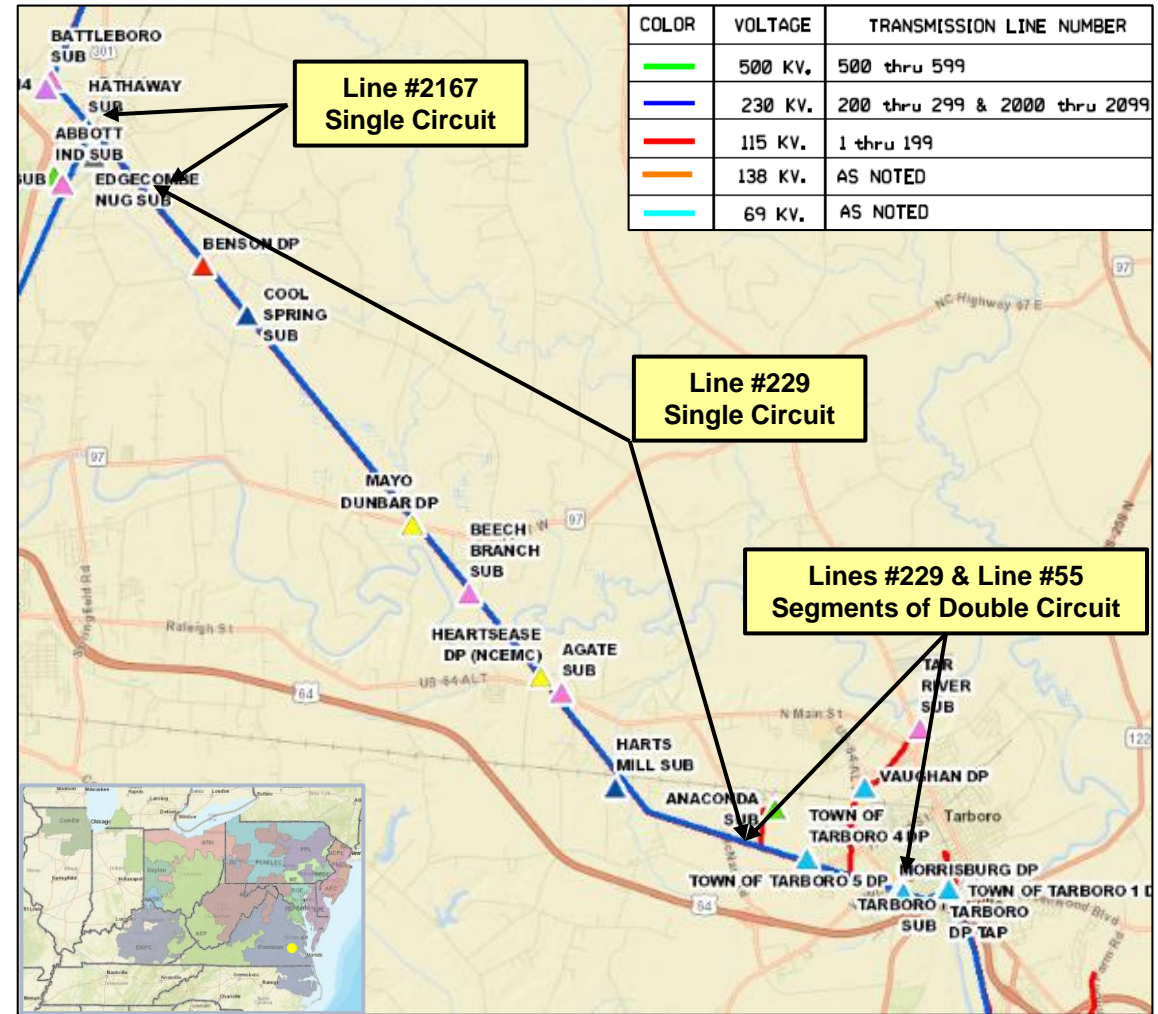

**Initially posted to 2023 Local Plan for s2825.1**  
**Updates to s2825.1 for 2024 Local Plan highlighted in red below**

# Dominion Transmission Zone: Supplemental Line #229 and Line #55 Partial Rebuild

**Need Number:** DOM-2021-0047

**Process Stage:**

Submission of Supplemental Project for Inclusion in the Local Plan – 02/21/2024

**Proposed Solution:**

Rebuild ~~entire~~ Line #2167 Edgecombe NUG Tap – Hathaway (approximately ~~0.73~~ **0.4** miles) to current 230kV standards with appropriate structures. The minimum normal summer conductor rating of this line will be 1573 MVA. Rebuild ~~entire~~ Line #229 Edgecombe NUG Tap – Tarboro (approximately ~~46.9~~ **16.6** miles) to current 230kV standards with appropriate structures. The minimum normal summer conductor rating of the line will be 1573 MVA. **Line #2167 rebuilt section will be connected to Line #229 at the Edgecombe NUG Tap and will be renumbered to Line #229. Line #229 becomes Tarboro to Hathaway and the double-circuit line from Edgecombe NUG Tap to Edgecombe NUG will be disconnected and made idle. (s2825.1)**

Rebuild approximately 3 miles from Tarboro to Str 55/133 of Line #55 Tarboro – Harts Mill to current 115kV standards with appropriate structures. The minimum normal summer conductor rating of the line will be 393 MVA.

Terminal equipment will be upgraded as necessary. (s2825.2)

**Estimated Project Cost:** \$ ~~40~~ **43**M

**Alternatives Considered:**

No feasible alternatives

**Project Target In-service Date:** 12/31/2023

**Project Status:** Conceptual **Construction**

**Model:** 2025 RTEP

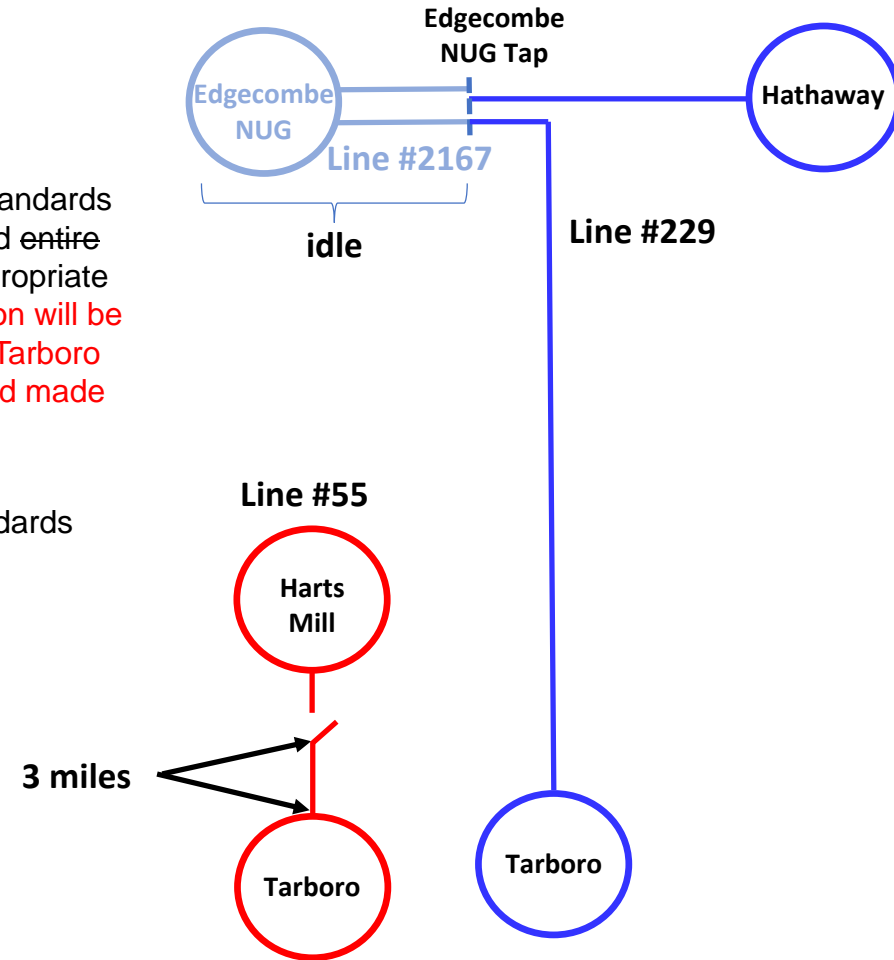

# Dominion Transmission Zone M-3 Process Barrister 230kV Delivery - DEV

**Need Number:** DOM-2022-0001

**Process Stage:**

Submission of Supplemental Project for Inclusion in the Local Plan – 02/21/2024

**Previously Presented:**

Need – 06/07/2022

Solution – 08/09/2022

**Project Driver:**

Customer Service

**Specific Assumption Reference:**

Customer load request will be evaluated per Dominion’s Facility Interconnection Requirements Document and Dominion’s Transmission Planning Criteria.

**Problem Statement:**

DEV Distribution has submitted a DP Request for a new substation (Barrister) in Loudoun County with a total load in excess of 100MW. Requested in-service date is 6/30/2026.

**Projected 2027 Load**

**Summer:** 147.0 MW

**Winter:** 130.0 MW

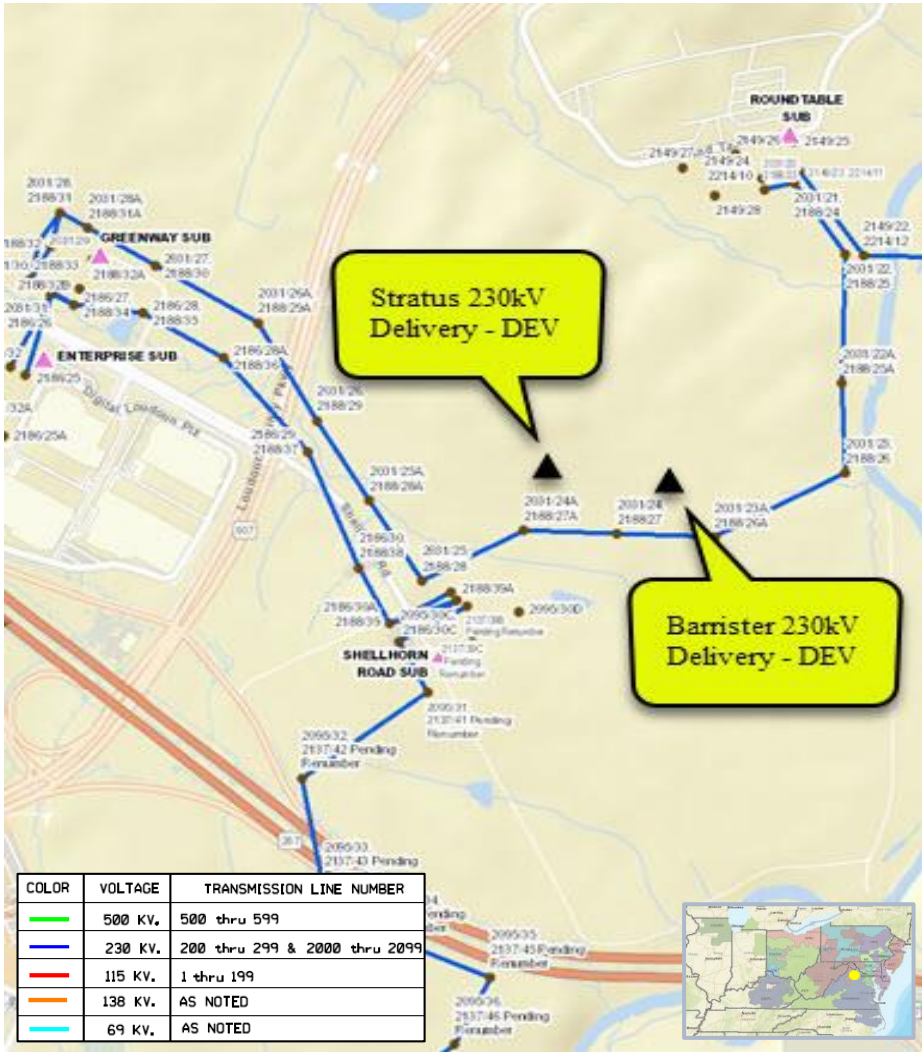

# Dominion Transmission Zone M-3 Process Barrister 230kV Delivery - DEV

**Need Number:** DOM-2022-0001

**Process Stage:**

Submission of Supplemental Project for Inclusion in the Local Plan – 02/21/2024

**Selected Solution:**

Interconnect the new substation by cutting and extending Line from Roundtable to Stratus and Line from Lockridge to Stratus into the proposed Barrister Substation. Terminate both ends into a six-breaker ring bus arrangement to create Roundtable- Barrister, Lockridge-Barrister lines as well as two Stratus-Barrister lines.

Need Number DOM-2022-0041 (Stratus 230kV Delivery - DEV ) is adjacent to Barrister Substation.

**Estimated Cost:** \$24.0M (Total)

Barrister Substation	\$10.0M
Line Extension	\$ 2.0M
Barrister Land Purchase	\$12.0M

**Projected In-Service:** 06/30/2026

**Supplemental Project ID:** s3027

**Project Status:** Engineering

**Model:** 2025 RTEP

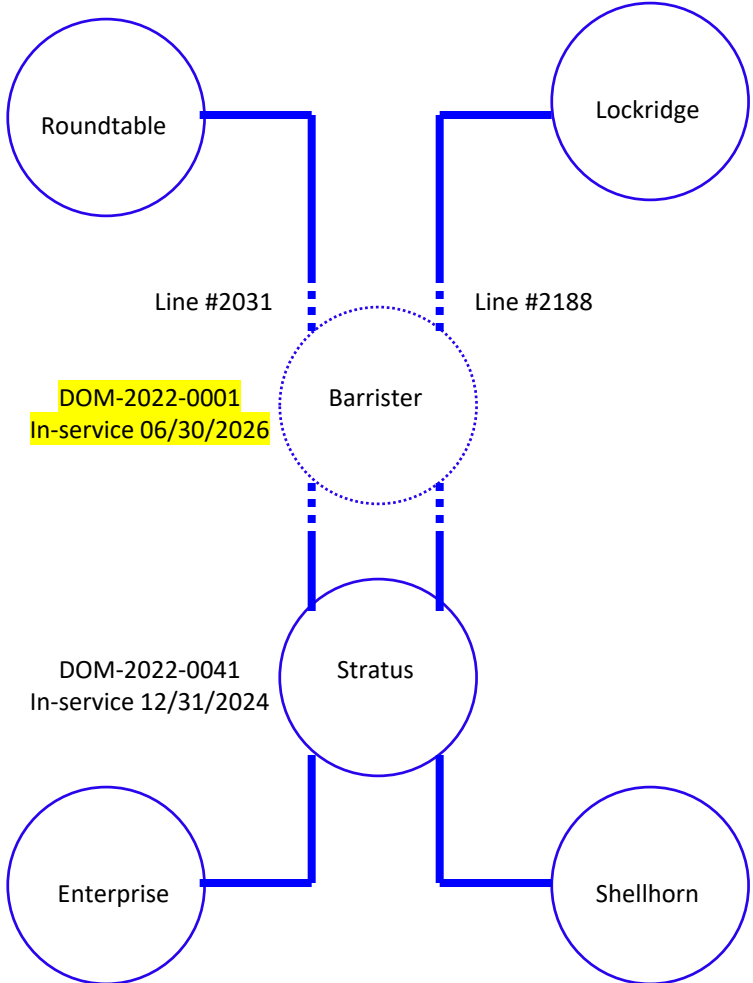

# Dominion Transmission Zone M-3 Process

## Ocean Court 230kV Delivery - DEV

**Need Number:** DOM-2022-0002

**Process Stage:**

Submission of Supplemental Project for Inclusion in the Local Plan – 02/21/2024

**Previously Presented:**

Need – 06/07/2022

Solution – 08/09/2022

**Project Driver:**

Customer Service

**Specific Assumption Reference:**

Customer load request will be evaluated per Dominion’s Facility Interconnection Requirements Document and Dominion’s Transmission Planning Criteria.

**Problem Statement:**

DEV Distribution has submitted a DP Request for a new substation (Ocean Court) in Loudoun County with a total load in excess of 100MW. Requested in-service date is 6/30/2024.

**Projected 2027 Load**

**Summer:** 158.0 MW

**Winter:** 142.7 MW

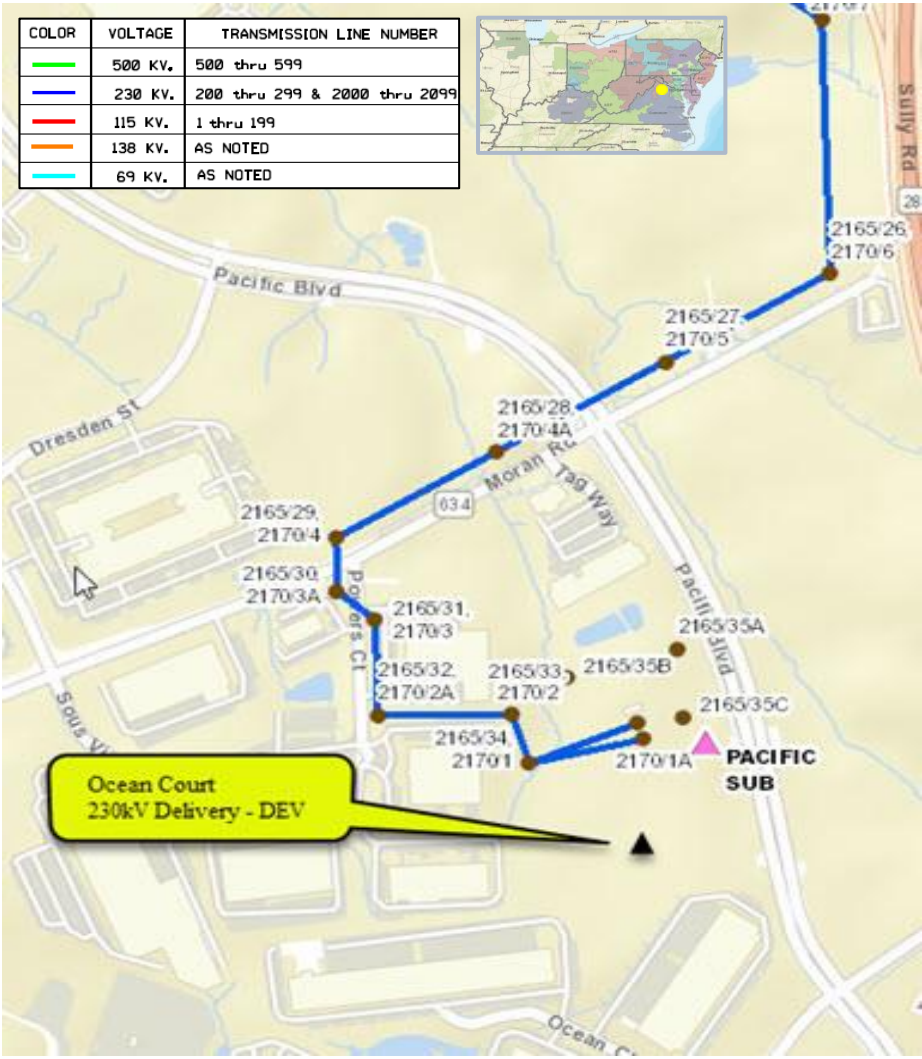



# Dominion Transmission Zone M-3 Process Ocean Court 230kV Delivery - DEV

**Need Number:** DOM-2022-0002

**Process Stage:**

Submission of Supplemental Project for Inclusion in the Local Plan – 02/21/2024

**Selected Solution:**

Cut and extend Line #2231 (Global Plaza-Pacific) to the proposed Ocean Court Substation. Terminate lines in a four-breaker 230kV ring bus with an ultimate arrangement of six-breaker ring.

**Estimated Cost:** \$10.0M (Total)

**Projected In-Service:** 06/30/2024

**Supplemental Project ID:** s3028

**Project Status:** Engineering

**Model:** 2025 RTEP

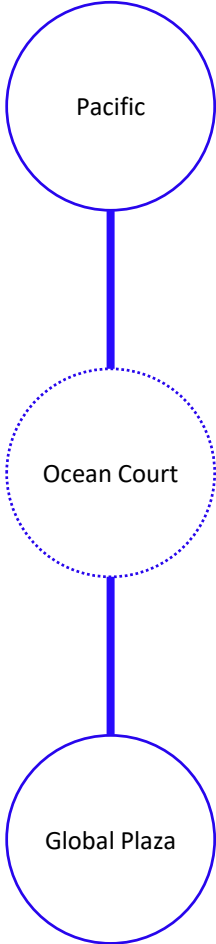

# Dominion Transmission Zone M-3 Process Pleasant View - Add 4<sup>th</sup> TX - DEV

**Need Number:** DOM-2022-0010

**Process Stage:**

Submission of Supplemental Project for Inclusion in the Local Plan – 02/21/2024

**Previously Presented:**

Need – 03/08/2022

Solution – 08/09/2022

**Project Driver:**

Customer Service

**Specific Assumption Reference:**

Customer load request will be evaluated per Dominion’s Facility Interconnection Requirements Document and Dominion’s Transmission Planning Criteria.

**Problem Statement:**

DEV Distribution has submitted a DP Request to add the 4<sup>th</sup> distribution transformer at Pleasant View Substation in Loudoun County. The new transformer is being driven by continued load growth in the area. Requested in-service date is 07/15/2023.

**Projected 2027 Load**

**Summer:** 55.0 MW

**Winter:** 55.0 MW

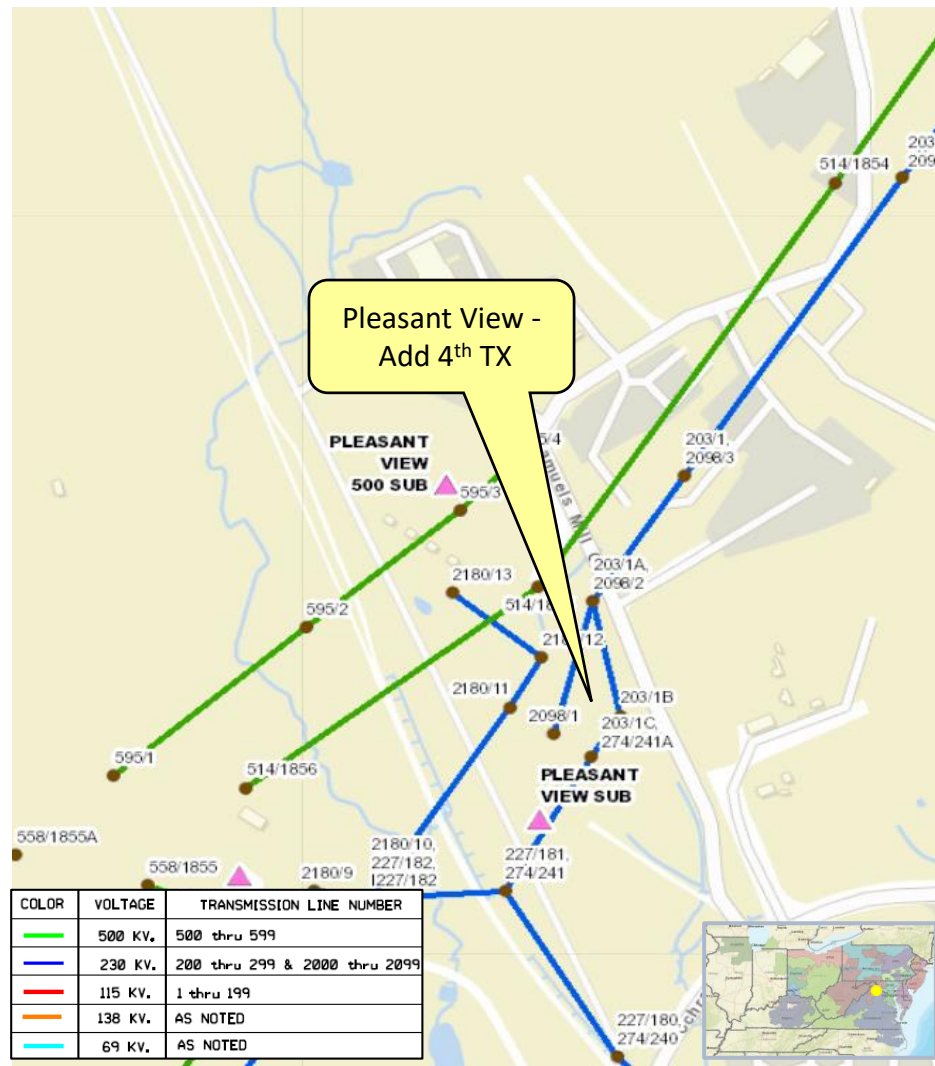

# Dominion Transmission Zone M-3 Process Pleasant View - Add 4<sup>th</sup> TX - DEV

**Need Number:** DOM-2022-0010

**Process Stage:**

Submission of Supplemental Project for Inclusion in the Local Plan – 02/21/2024

**Selected Solution:**

Install a 1200 Amp, 50kAIC circuit switcher and associated equipment (bus, relaying, etc.) to feed the new transformer at Pleasant View.

**Estimated Cost:** \$1.0 M

**Projected In-Service:** 03/06/2025

**Supplemental Project ID:** s3029

**Project Status:** Engineering

**Model:** 2025 RTEP

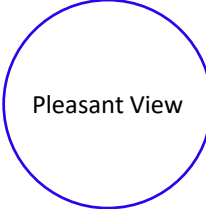

# Dominion Transmission Zone M-3 Process Dawkins Branch 230kV Delivery - NOVEC

**Need Number:** DOM-2022-0017

**Process Stage:**  
Submission of Supplemental Project for Inclusion in the Local Plan – 02/21/2024

**Previously Presented:**  
Need – 06/07/2022  
Solution – 07/12/2022

**Project Driver:**  
Customer Service

**Specific Assumption Reference:**  
Customer load request will be evaluated per Dominion’s Facility Interconnection Requirements Document and Dominion’s Transmission Planning Criteria.

**Problem Statement:**  
NOVEC has submitted a DP Request for a new substation (Dawkins Branch) to serve a data center complex in Prince William County with a total load in excess of 100 MW. Requested in-service date is 07/01/2023.

**Projected 2027 Load**  
**Summer:** 73.0 MW  
**Winter:** 76.8 MW

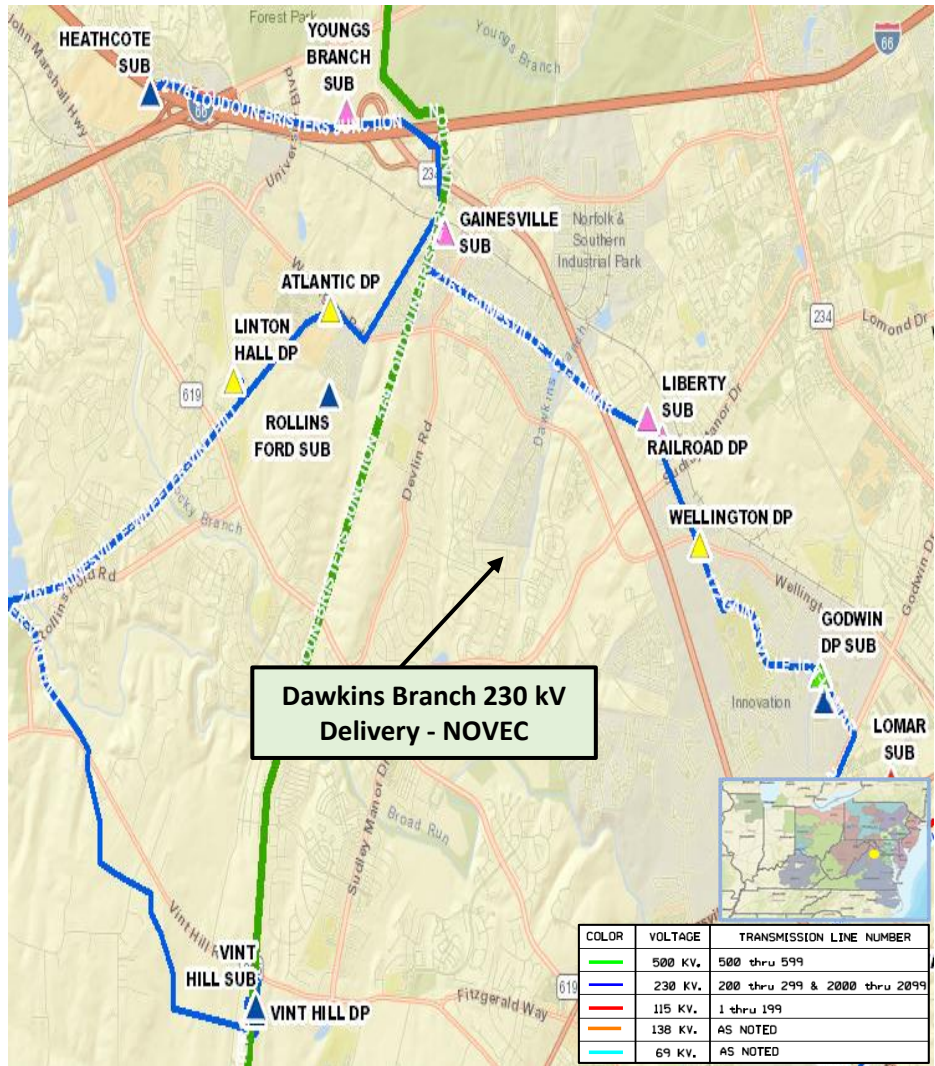

# Dominion Transmission Zone M-3 Process Dawkins Branch 230kV Delivery - NOVEC

**Need Number:** DOM-2022-0017

**Process Stage:**

Submission of Supplemental Project for Inclusion in the Local Plan – 02/21/2024

**Selected Solution:**

Interconnect the new substation by cutting and extending Line #2163 (Vint Hill - Liberty) to the proposed Dawkins Branch Substation. Terminate both ends into a four-breaker ring arrangement to create a Vint Hill – Dawkins Branch line and a Dawkins Branch - Liberty line.

**Estimated Cost:** \$16.0M

**Projected In-Service:** 06/30/2023

**Supplemental Project ID:** s3018

**Project Status:** Complete

**Model:** 2025 RTEP

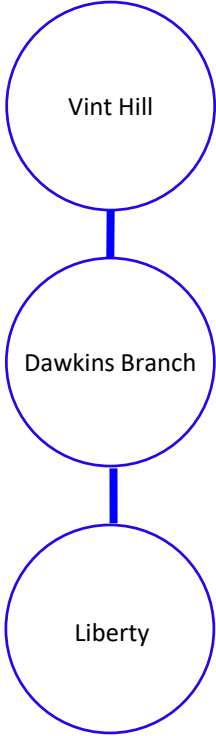

# Dominion Transmission Zone M-3 Process Garrisonville - Add 2<sup>nd</sup> TX - DEV

**Need Number:** DOM-2022-0019

**Process Stage:**

Submission of Supplemental Project for Inclusion in the Local Plan – 02/21/2024

**Previously Presented:**

Need – 06/07/2022

Solution – 07/12/2022

**Project Driver:**

Customer Service

**Specific Assumption Reference:**

Customer load request will be evaluated per Dominion’s Facility Interconnection Requirements Document and Dominion’s Transmission Planning Criteria.

**Problem Statement:**

DEV Distribution has submitted a DP Request to add a 2<sup>nd</sup> distribution transformer at Garrisonville Substation in Stafford County. The new transformer is being driven by significant area load growth. Requested in-service date is 12/31/2023.

**Projected 2027 Load**

**Summer:** 59.9 MW

**Winter:** 74.4 MW

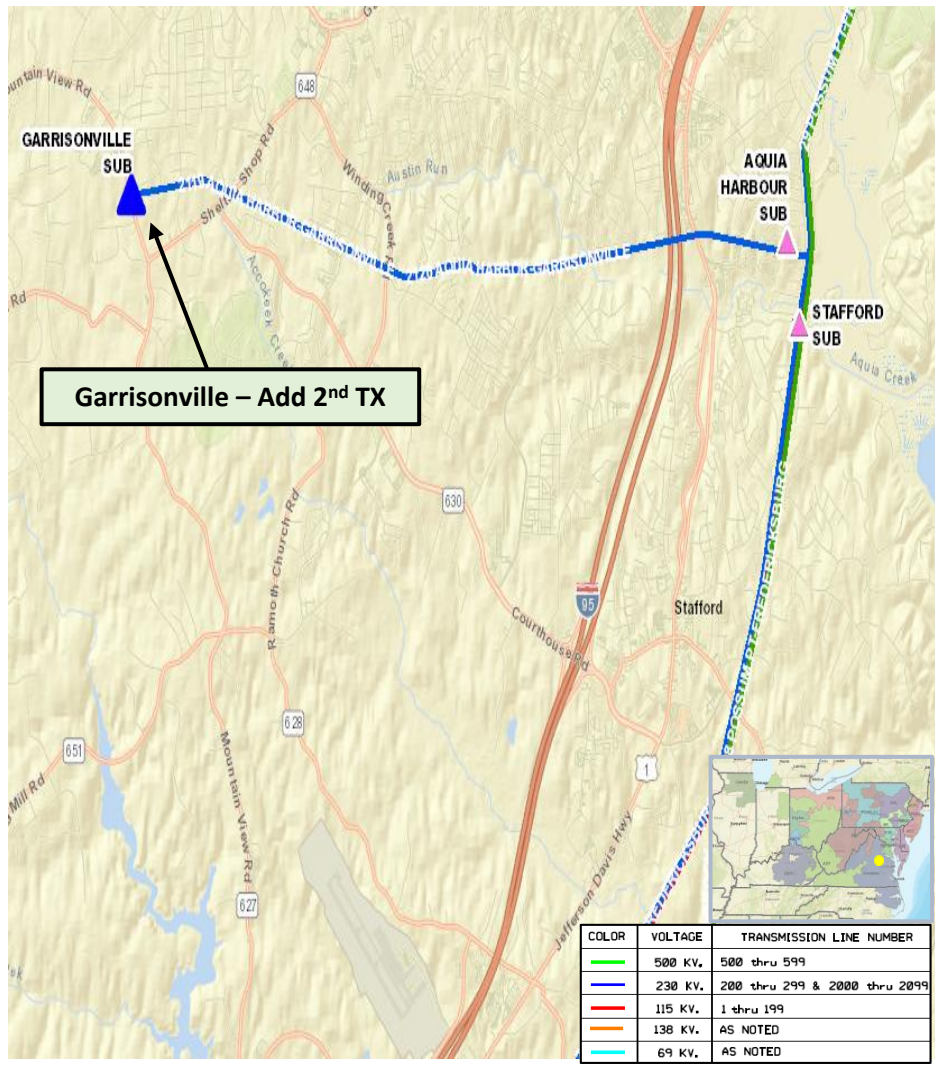

# Dominion Transmission Zone M-3 Process Garrisonville - Add 2<sup>nd</sup> TX - DEV

**Need Number:** DOM-2022-0019

**Process Stage:**

Submission of Supplemental Project for Inclusion in the Local Plan – 02/21/2024

**Selected Solution:**

Install a 1200 Amp, 50kAIC circuit switcher and associated equipment (bus, relaying, etc.) to feed the new transformer at Garrisonville.

**Estimated Cost:** \$0.75M

**Projected In-Service:** 05/17/2024

**Supplemental Project ID:** s3019

**Project Status:** Construction

**Model:** 2025 RTEP



# Dominion Transmission Zone M-3 Process Youngs Branch - Add 2<sup>nd</sup> TX - DEV

**Need Number:** DOM-2022-0020

**Process Stage:**

Submission of Supplemental Project for Inclusion in the Local Plan – 02/21/2024

**Previously Presented:**

Need – 06/07/2022

Solution – 07/12/2022

**Project Driver:**

Customer Service

**Specific Assumption Reference:**

Customer load request will be evaluated per Dominion’s Facility Interconnection Requirements Document and Dominion’s Transmission Planning Criteria.

**Problem Statement:**

DEV Distribution has submitted a DP Request to add a 2<sup>nd</sup> distribution transformer at Youngs Branch Substation in Prince William County. The new transformer is being driven by datacenter load growth. Requested in-service date is 10/15/2023.

**Projected 2027 Load**

**Summer:** 141.6 MW

**Winter:** 124.5 MW

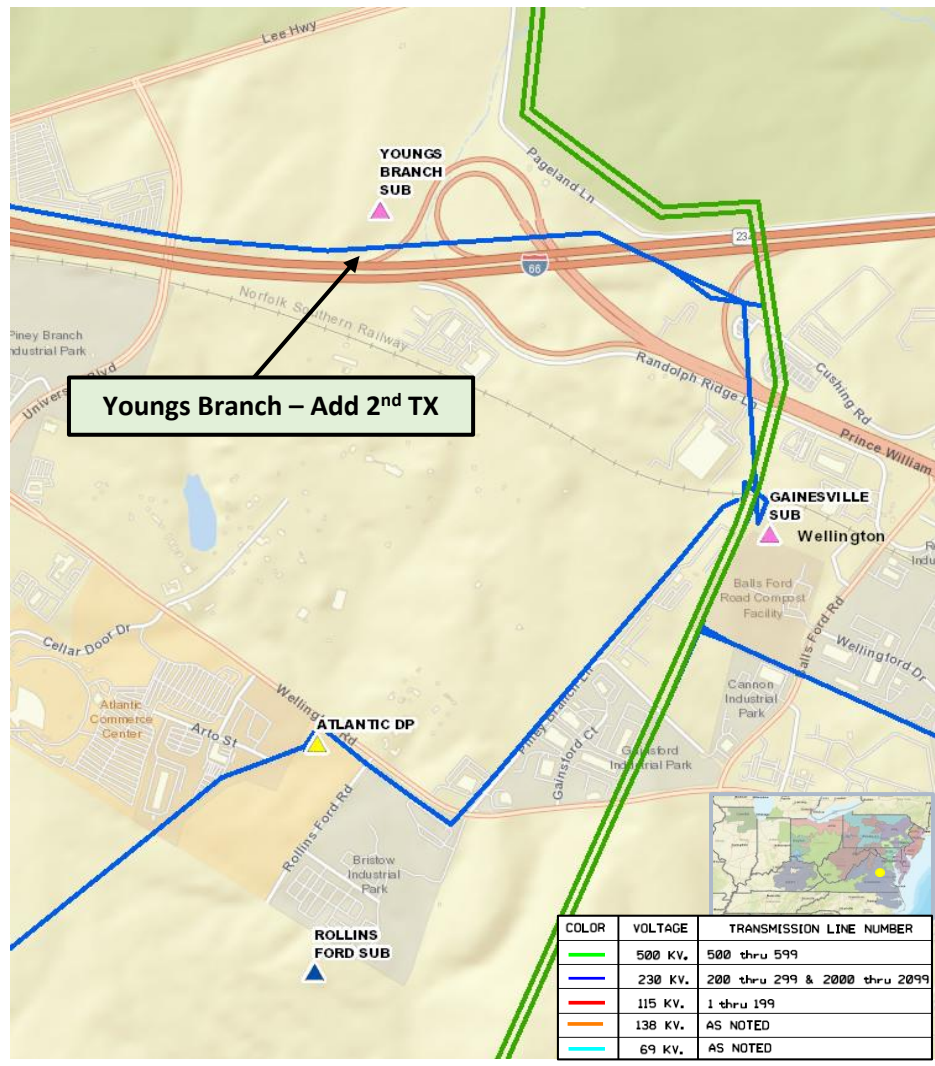



# Dominion Transmission Zone M-3 Process

## Youngs Branch - Add 2<sup>nd</sup> TX - DEV

**Need Number:** DOM-2022-0020

**Process Stage:**

Submission of Supplemental Project for Inclusion in the Local Plan – 02/21/2024

**Selected Solution:**

Install a 1200 Amp, 50kAIC circuit switcher and associated equipment (bus, relaying, etc.) to feed the new transformer at Youngs Branch.

**Estimated Cost:** \$0.75M

**Projected In-Service:** 03/28/2024

**Supplemental Project ID:** s3020

**Project Status:** Construction

**Model:** 2025 RTEP

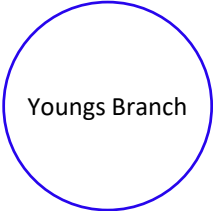

# Dominion Transmission Zone M-3 Process

## Replace Farmville TX#5 - DEV

**Need Number:** DOM-2022-0023

**Process Stage:**

Submission of Supplemental Project for Inclusion in the Local Plan – 02/21/2024

**Previously Presented:**

Need – 04/12/2022

Solution – 09/06/2022

**Project Driver:**

Equipment Material Condition, Performance, and Risk

**Specific Assumption Reference:**

See details on Equipment Material Condition, Performance and Risk in Dominion’s Planning Assumptions presented in December 2021.

**Problem Statement:**

Farmville TX#5 is a 168 MVA, 230/115/13.2 kV transformer bank that was manufactured in 1981. This transformer bank has been identified for replacement based on the results of Dominion’s transformer health assessment (THA) process. Detailed drivers include:

- Age (>40 years old).
- Reduced BIL ratings (3 levels below standard).
- Tertiary winding design not meeting current MVA requirement for loading.
- Degraded porcelain type bushings.
- Oil DGA indicates high CO and CO2 levels; potential break down of dielectric paper insulation on main current carrying conductors inside the transformer.
- THA score less than 80.

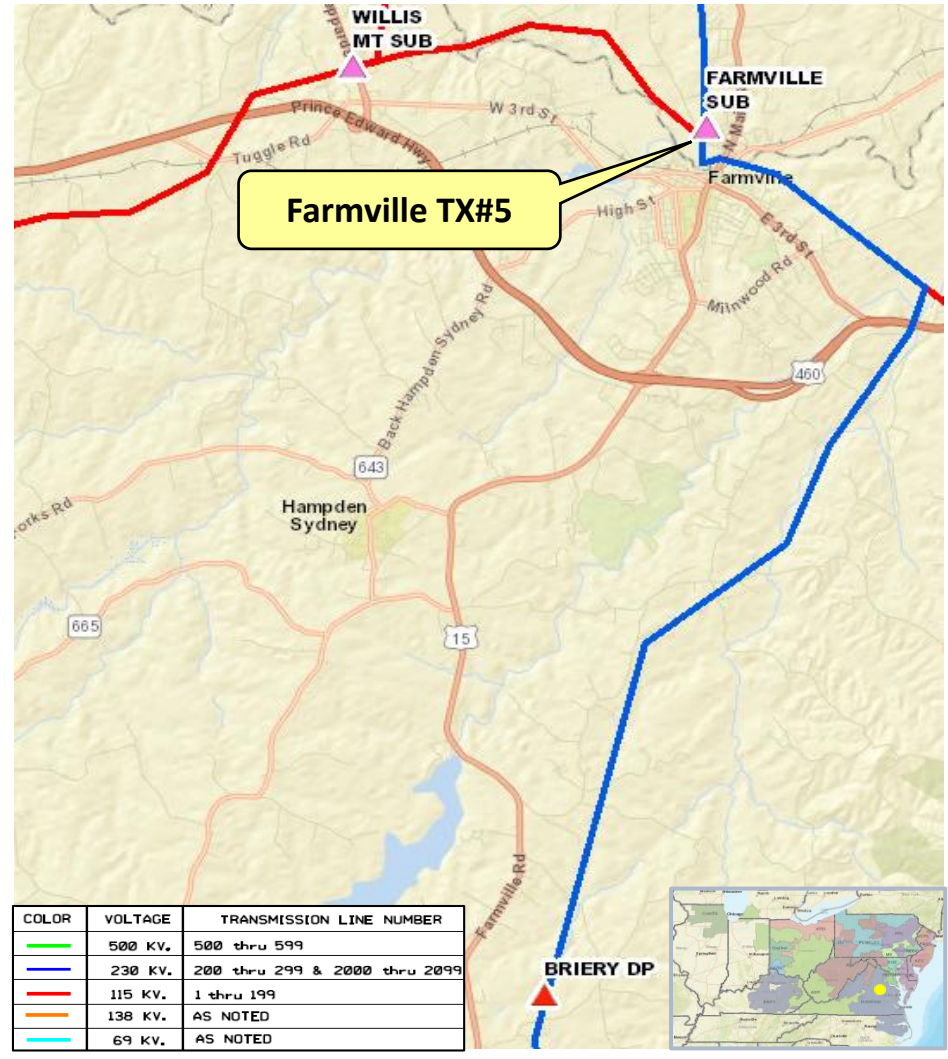

# Dominion Transmission Zone M-3 Process

## Replace Farmville TX#5 - DEV

**Need Number:** DOM-2022-0023

**Process Stage:**

Submission of Supplemental Project for Inclusion in the Local Plan – 02/21/2024

**Selected Solution:**

Replace Farmville TX#5 with a new three-phase, 230/115/13.2 kV, 168 MVA unit.  
Include other ancillary equipment (high side breaker, arresters, switches, relays, etc.) as needed.

**Estimated Cost:** \$6.4 M

**Projected In-Service:** 12/31/2024

**Supplemental Project ID:** s3041

**Project Status:** Engineering

**Model:** 2025 RTEP

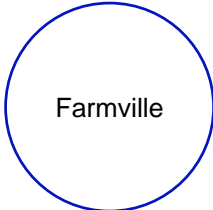

# Dominion Transmission Zone M-3 Process

## Replace Clubhouse TX#1 - DEV

**Need Number:** DOM-2022-0024

**Process Stage:**

Submission of Supplemental Project for Inclusion in the Local Plan – 02/21/2024

**Previously Presented:**

Need – 04/12/2022

Solution – 09/06/2022

**Project Driver:**

Equipment Material Condition, Performance, and Risk

**Specific Assumption Reference:**

See details on Equipment Material Condition, Performance and Risk in Dominion’s Planning Assumptions presented in December 2021.

**Problem Statement:**

Clubhouse TX#1 is a 168 MVA, 230/115/13.2 kV transformer bank that was manufactured in 1981. This transformer bank has been identified for replacement based on the results of Dominion’s transformer health assessment (THA) process. Detailed drivers include:

- Age (>40 years old).
- Reduced BIL ratings (3 levels below standard).
- Tertiary winding design not meeting current MVA requirement for loading.
- Degraded porcelain type bushings.
- Oil DGA indicates high CO and CO2 levels; potential break down of dielectric paper insulation on main current carrying conductors inside the transformer.
- THA score less than 80.

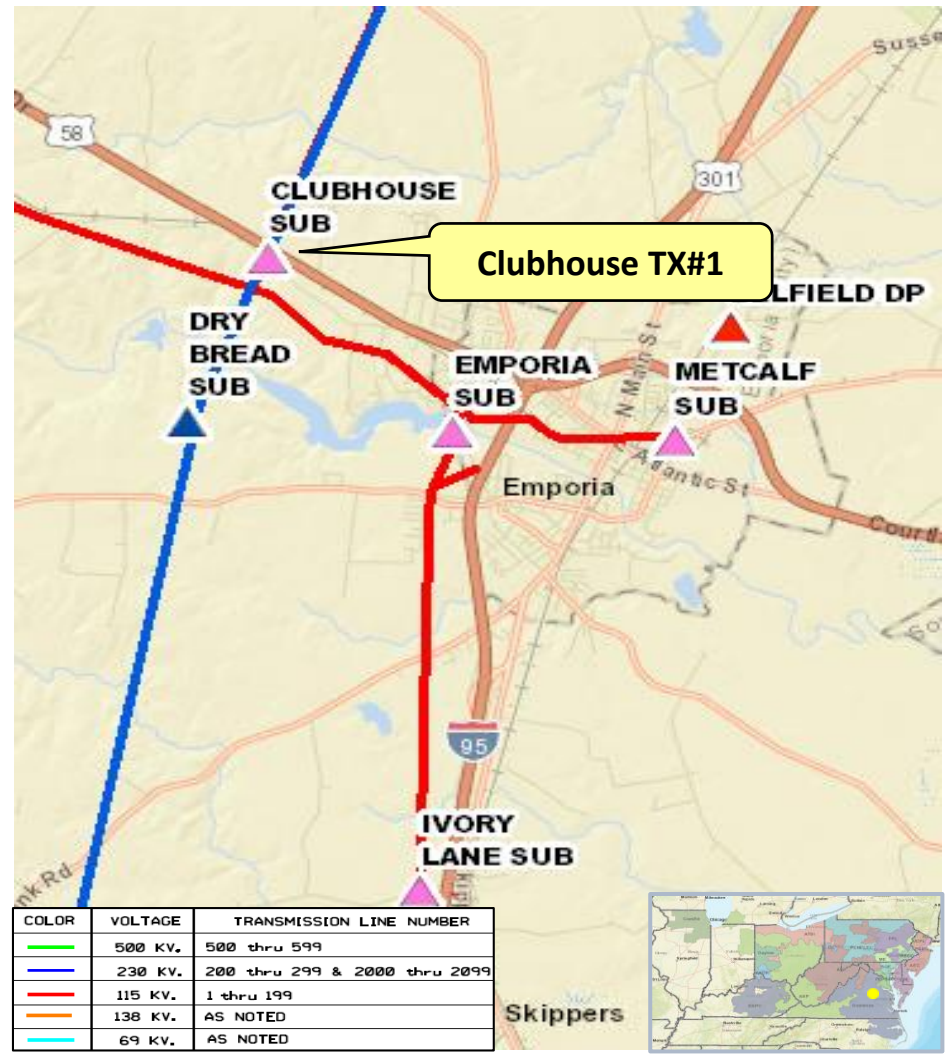

# Dominion Transmission Zone M-3 Process

## Replace Clubhouse TX#1 - DEV

**Need Number:** DOM-2022-0024

**Process Stage:**

Submission of Supplemental Project for Inclusion in the Local Plan – 02/21/2024

**Selected Solution:**

Replace Clubhouse TX#1 with a new three-phase, 230/115/13.2 kV, 224 MVA unit. Include other ancillary equipment (arresters, switches, relays, etc.) as needed.

**Estimated Cost:** \$6.6 M

**Projected In-Service:** 05/15/2024

**Supplemental Project ID:** s3042

**Project Status:** Construction

**Model:** 2025 RTEP

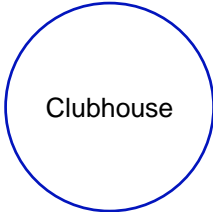

# Dominion Transmission Zone M-3 Process

## Evans Creek 230kV Delivery - DEV

**Need Number:** DOM-2022-0027

**Process Stage:**

Submission of Supplemental Project for Inclusion in the Local Plan – 02/21/2024

**Previously Presented:**

Need – 05/10/2022

Solution – 07/12/2022

**Project Driver:**

Customer Service

**Specific Assumption Reference:**

Customer load request will be evaluated per Dominion’s Facility Interconnection Requirements Document and Dominion’s Transmission Planning Criteria.

**Problem Statement:**

DEV Distribution has submitted a delivery point request (Roanoke DP) for a new delivery point to serve a data center customer in La Crosse, VA. The total load is in excess of 100 MW. The customer requests service by August 1, 2025.

**Projected 2027 Load**

**Summer:** 126.0 MW

**Winter:** 98.0 MW

COLOR	VOLTAGE	TRANSMISSION LINE NUMBER
Green	500 KV.	500 thru 599
Blue	230 KV.	200 thru 299 & 2000 thru 2099
Red	115 KV.	1 thru 199
Orange	138 KV.	AS NOTED
Cyan	69 KV.	AS NOTED

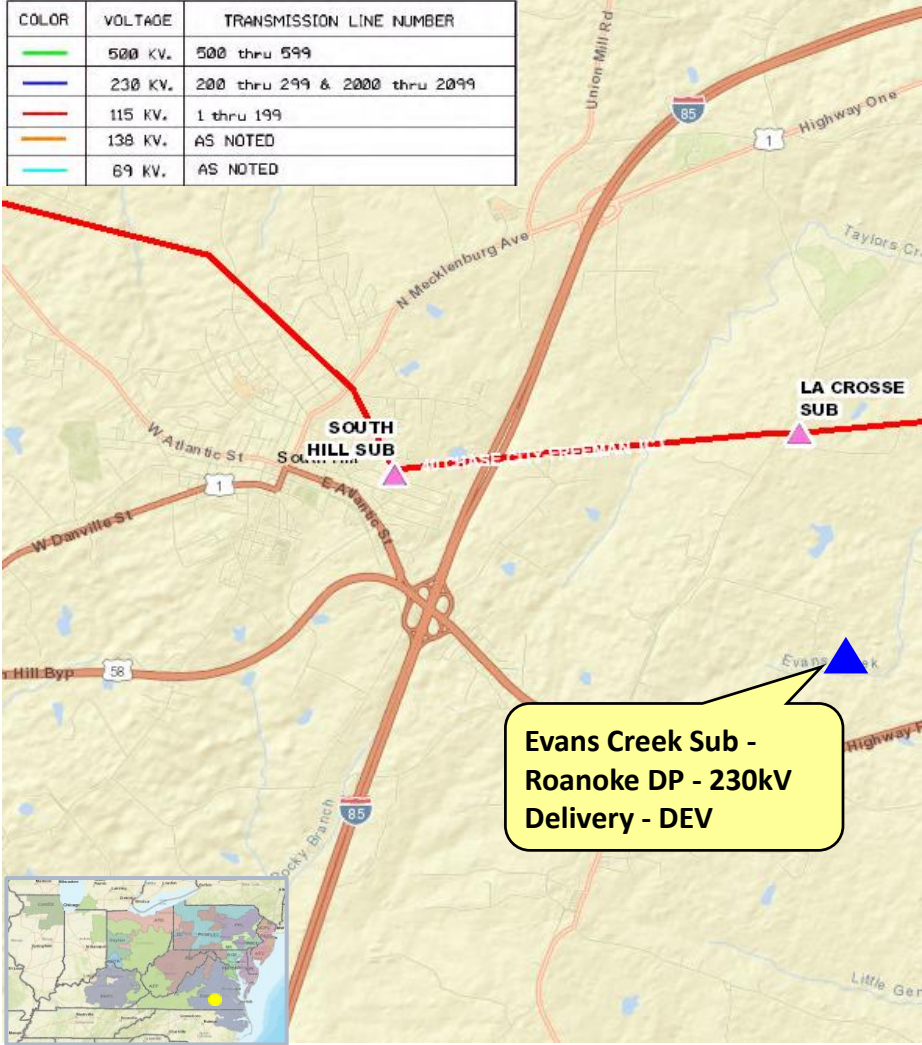

# Dominion Transmission Zone M-3 Process

## Evans Creek 230kV Delivery - DEV

**Need Number:** DOM-2022-0027

**Process Stage:**

Submission of Supplemental Project for Inclusion in the Local Plan – 02/21/2024

**Selected Solution:**

Construct Evans Creek 230kV substation with four breaker 230kV breaker ring bus to terminate two 230kV lines. Construct one new 230kV transmission line for approximately 5 miles from Tunstall Sub to Evans Creek Substation. Construct one new 230kV transmission line for approximately 3 miles from Raines Sub to Evans Creek Substation. New right-of-way will be needed for both transmission lines. New conductor to have a minimum summer normal rating of 1573 MVA.

**Estimated Cost:** \$30.0M (Total)

Transmission Line	\$15M
230kV Substation	\$15M

**Projected In-Service:** 08/01/2025

**Supplemental Project ID:** s3021

**Project Status:** Engineering

**Model:** 2025 RTEP

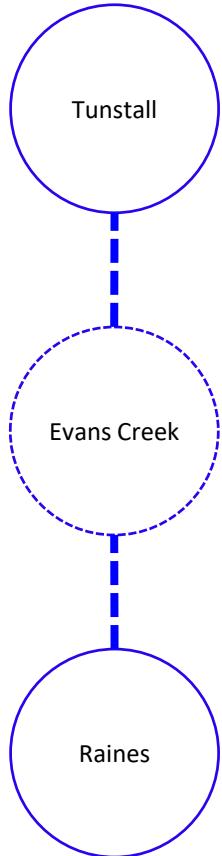

# Dominion Transmission Zone M-3 Process

## Tunstall 230kV Delivery - DEV

**Need Number:** DOM-2022-0028

**Process Stage:**

Submission of Supplemental Project for Inclusion in the Local Plan – 02/21/2024

**Previously Presented:**

Need – 05/10/2022

Solution – 07/12/2022

**Project Driver:**

Customer Service

**Specific Assumption Reference:**

Customer load request will be evaluated per Dominion’s Facility Interconnection Requirements Document and Dominion’s Transmission Planning Criteria.

**Problem Statement:**

DEV Distribution has submitted a delivery point request (Hillcrest DP) for a new delivery point to serve a data center customer in South Hill, VA. The total load is in excess of 100 MW. The customer requests service by August 1, 2025.

**Projected 2027 Load**

**Summer:** 77.0 MW

**Winter:** 59.0 MW

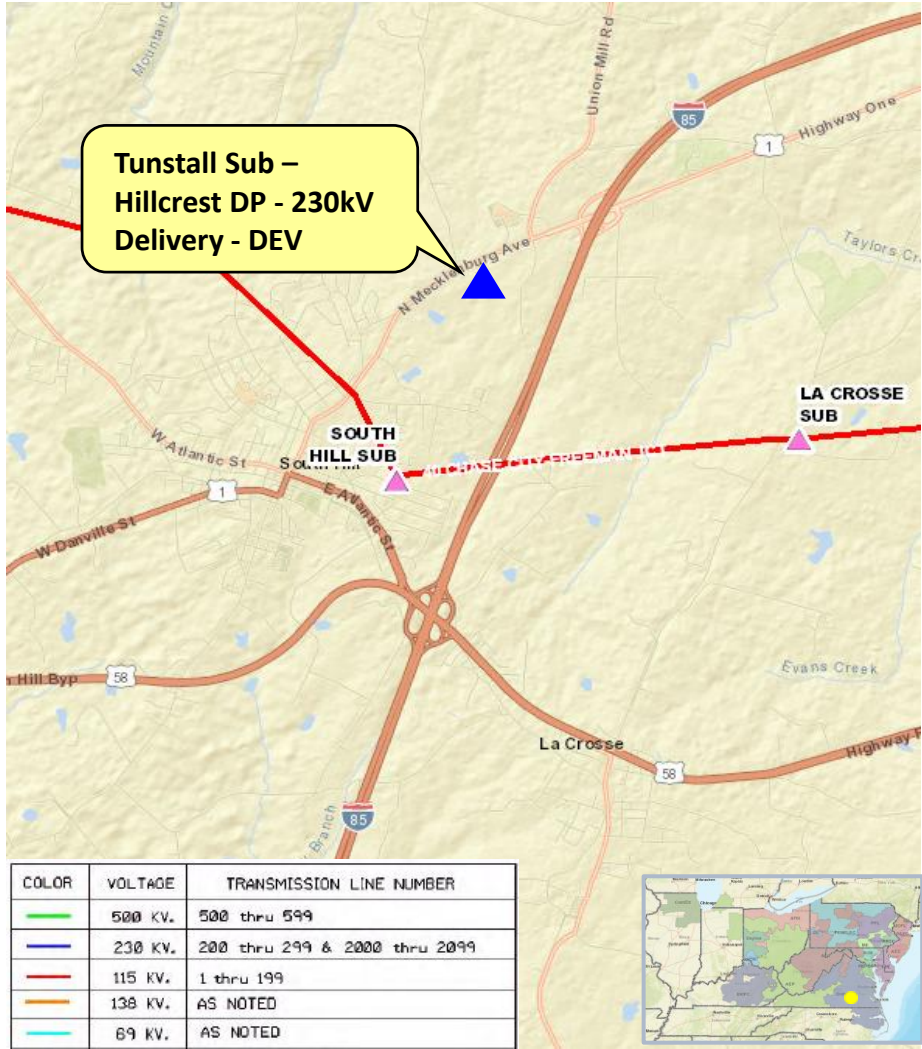



# Dominion Transmission Zone M-3 Process

## Tunstall 230kV Delivery - DEV

**Need Number:** DOM-2022-0028

**Process Stage:**

Submission of Supplemental Project for Inclusion in the Local Plan – 02/21/2024

**Selected Solution:**

- Obtain land and build a new 500/230kV Unity switching station near the intersection of Line #593 (Finneywood-Rawlings) and Route 138.
- Cut and terminate Line #593 into Unity 500/230kV switching station. In the new Unity switching station, install two 840 MVA 500/230kV transformers, a 230kV ring bus with 6 breakers and a 500kV ring bus with 6 breakers.
- Construct Tunstall 230kV substation with four rows of 230kV breaker and half bus to terminate four 230kV lines.
- Construct two new 230kV single circuit transmission lines for approximately 11 miles from Unity Sub to Tunstall Substation.
- New right-of-way will be needed for both transmission lines. New conductor to have a minimum summer normal rating of 1573 MVA.

**Estimated Cost:** \$140.0M (Total)

Transmission Line	\$40M
500kV Substation	\$80M
230kV Substation	\$20M

**Projected In-Service:** 08/01/2025

**Supplemental Project ID:** s3022

**Project Status:** Engineering

**Model:** 2025 RTEP

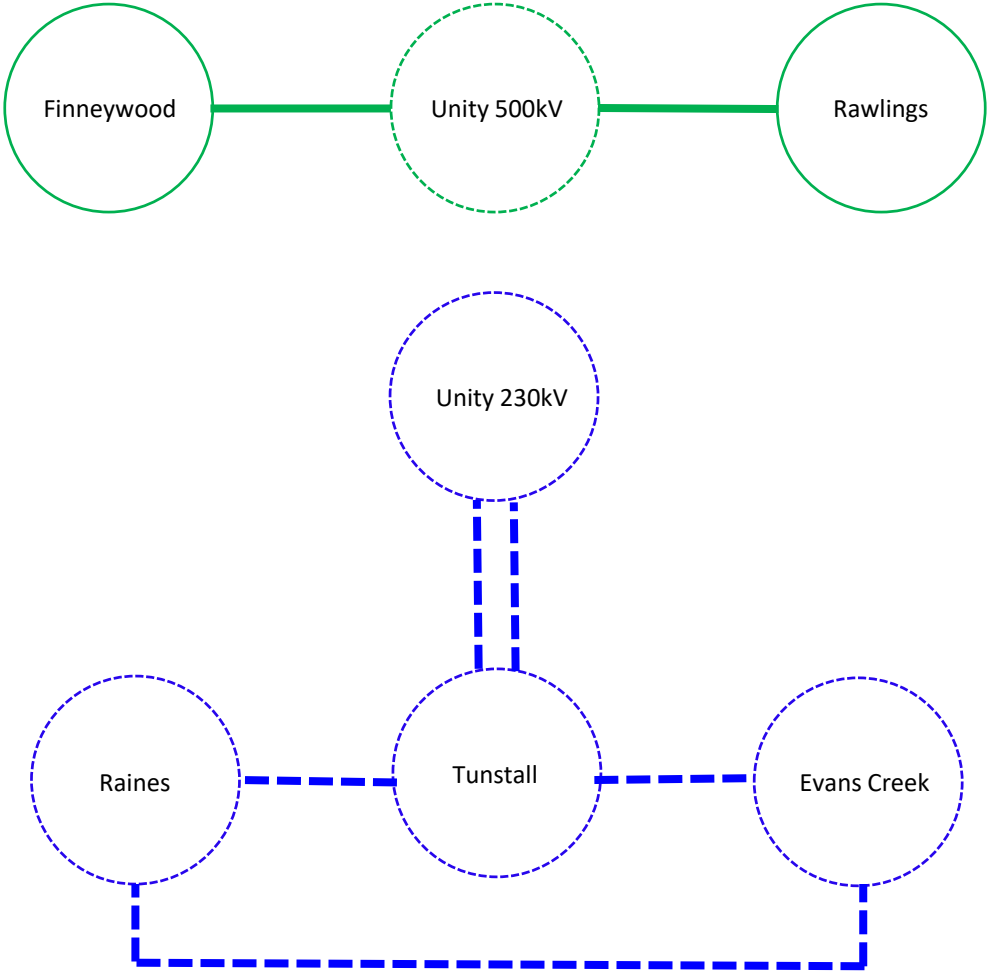
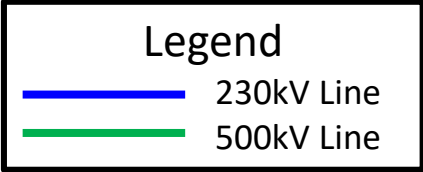

# Dominion Transmission Zone M-3 Process

## Raines 230kV Delivery - DEV

**Need Number:** DOM-2022-0029

**Process Stage:**

Submission of Supplemental Project for Inclusion in the Local Plan – 02/21/2024

**Previously Presented:**

Need – 05/10/2022

Solution – 07/12/2022

**Project Driver:**

Customer Service

**Specific Assumption Reference:**

Customer load request will be evaluated per Dominion’s Facility Interconnection Requirements Document and Dominion’s Transmission Planning Criteria.

**Problem Statement:**

DEV Distribution has submitted a delivery point request (Interstate DP) for a new delivery point to serve a data center customer in La Crosse, VA. The total load is less than 100 MW. The customer requests service by August 1, 2025.

**Projected 2027 Load**

**Summer:** 37.0 MW

**Winter:** 25.0 MW

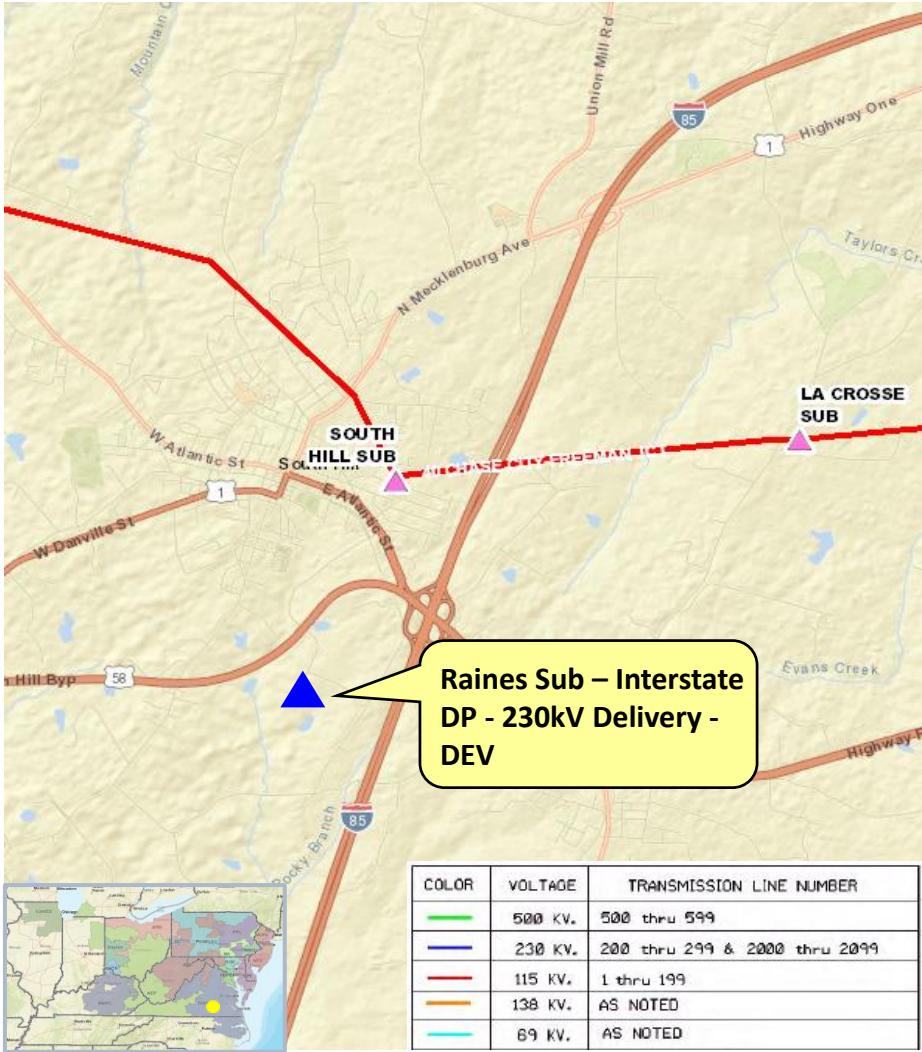

# Dominion Transmission Zone M-3 Process

## Raines 230kV Delivery - DEV

**Need Number:** DOM-2022-0029

**Process Stage:**

Submission of Supplemental Project for Inclusion in the Local Plan – 02/21/2024

**Selected Solution:**

Construct Raines 230kV substation with four breaker 230kV breaker ring bus to terminate two 230kV lines. Construct one new 230kV transmission line for approximately 8 miles from Tunstall Sub to Raines Substation. New right-of-way will be needed for the transmission line. New conductor to have a minimum summer normal rating of 1573 MVA.

Due to the total load requested less than 100 MW, the data center customer will be required to pay excess facilities for all equipment required for the ring bus configuration above a T-tap.

**Estimated Cost:** \$20.0M (Total)

Transmission Line	\$15M
230kV Substation	\$5M

**Projected In-Service:** 08/01/2025

**Supplemental Project ID:** s3023

**Project Status:** Engineering

**Model:** 2025 RTEP

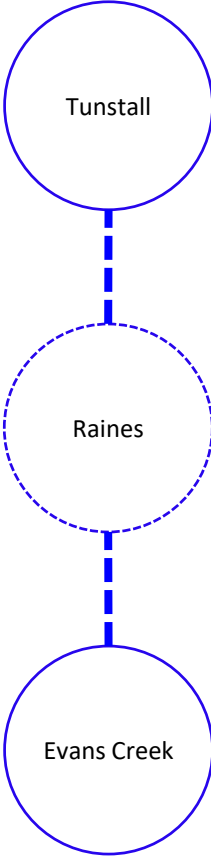

# Dominion Transmission Zone M-3 Process Mountain Run 230kV Delivery - REC

**Need Number:** DOM-2022-0034

**Process Stage:**

Submission of Supplemental Project for Inclusion in the Local Plan – 02/21/2024

**Previously Presented:**

Need – 06/07/2022

Solution – 09/06/2022

**Project Driver:**

Customer Service

**Specific Assumption Reference:**

Customer load request will be evaluated per Dominion’s Facility Interconnection Requirements Document and Dominion’s Transmission Planning Criteria.

**Problem Statement:**

Rappahannock Electric Cooperative (REC) has submitted a two DP Requests. One to increase capacity at their existing 115kV Mountain Run DP and one for a new substation in the vicinity of the Mountain Run DP to serve a new data center complex in Culpeper County with a total projected load of 350 MW. The requested in-service date is 06/01/2024.

**Projected 2027 Load**

**Summer:** 140.7 MW

**Winter:** 140.7 MW

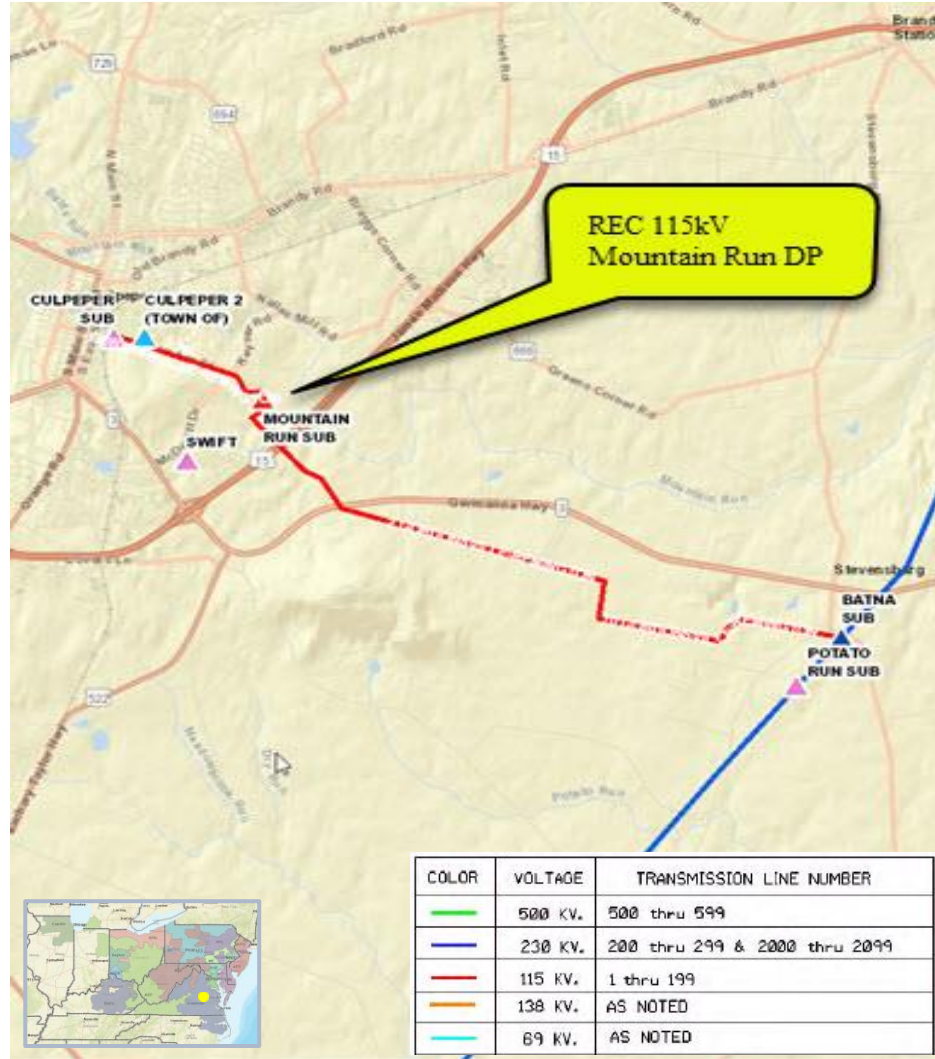

# Dominion Transmission Zone M-3 Process Mountain Run 230kV Delivery - REC

**Need Number:** DOM-2022-0034

**Process Stage:**

Submission of Supplemental Project for Inclusion in the Local Plan – 02/21/2024

**Selected Solution:**

1. Build new Kyser switching station to feed REC’s existing Mountain Run DP. The initial build will include four 230kV breakers, associated bus, switches, etc.
2. Build new Cirrus switching station to feed REC’s new DP. The initial build will include four 230kV breakers, associated bus, switches, etc.
3. Wreck and rebuild approximately five miles of existing double-circuit 115kV Line #2 and Line #70, using 230kV construction, from Mountain Run Junction to the new Kyser/Cirrus switching stations.
4. Cut 230kV Line #2199 at Mountain Run Junction and feed the rebuilt double-circuit line to Kyser/Cirrus switching stations.
5. Re-connect the remaining sections of 115kV Lines #2 and Line #70 at Mountain Run Junction.
6. REC to convert their existing Mountain Run DP to 230kV.
7. Install a 230/115kV – 168 MVA transformer and spare at Cirrus switching station to maintain the 115kV feed to Culpeper and Culpeper DP.

<b>Estimated Cost:</b>	\$60.0 M (Total)
Transmission Line	\$22.0M
Substation	\$38.0M

**Projected In-Service:** 12/30/2025

**Supplemental Project ID:** s3044

**Project Status:** Engineering

**Model:** 2025 RTEP

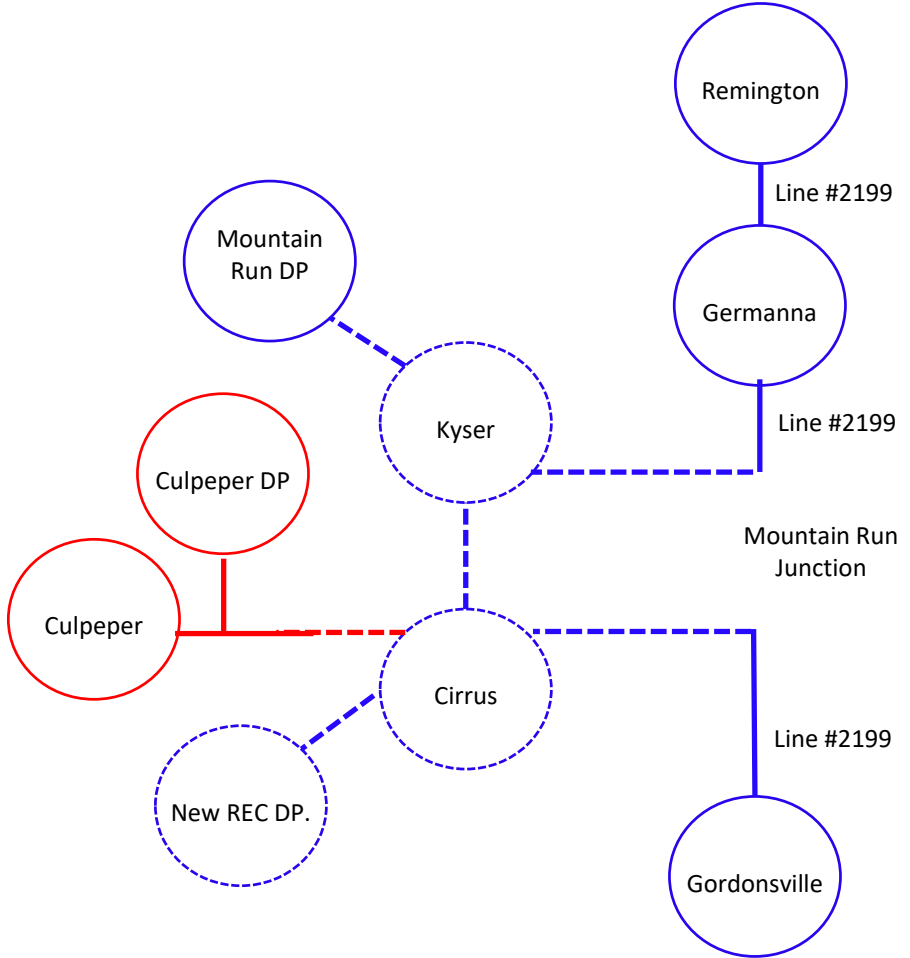

# Dominion Transmission Zone M-3 Process Northstar 230kV Delivery - DEV

**Need Number:** DOM-2022-0035

**Process Stage:**

Submission of Supplemental Project for Inclusion in the Local Plan – 02/21/2024

**Previously Presented:**

Need – 06/07/2022

Solution – 07/12/2022

**Project Driver:**

Customer Service

**Specific Assumption Reference:**

Customer load request will be evaluated per Dominion’s Facility Interconnection Requirements Document and Dominion’s Transmission Planning Criteria.

**Problem Statement:**

NOVEC has submitted a DP Request for a new substation (Northstar) in Loudoun County with a total load in excess of 100MW. Requested in-service date is 01/01/2025.

**Projected 2027 Load**

**Summer:** 124.0 MW

**Winter:** 153.0 MW



# Dominion Transmission Zone M-3 Process Northstar 230kV Delivery - DEV

**Need Number:** DOM-2022-0035

**Process Stage:**

Submission of Supplemental Project for Inclusion in the Local Plan – 02/21/2024

**Selected Solution:**

Interconnect the new substation by cutting and extending Line #2045 (Brambleton-Loudoun) to the proposed Northstar Substation. Lines to terminate in a 230kV four-breaker ring arrangement with an ultimate arrangement of a six-breaker ring.

**Estimated Cost:** \$10.0M

**Projected In-Service:** 01/01/2025

**Supplemental Project ID:** s3024

**Project Status:** Engineering

**Model:** 2025 RTEP

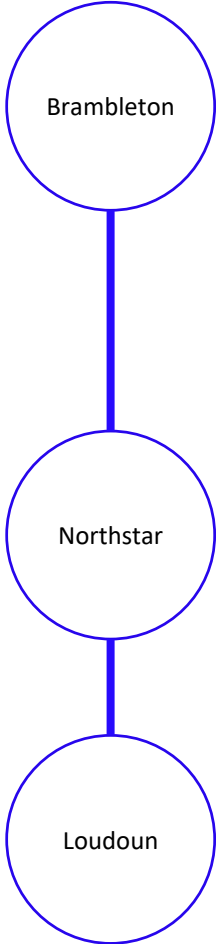

# Dominion Transmission Zone M-3 Process Thunderball 230kV Delivery - DEV

**Need Number:** DOM-2022-0036

**Process Stage:**

Submission of Supplemental Project for Inclusion in the Local Plan – 02/21/2024

**Previously Presented:**

Need – 06/07/2022

Solution – 07/12/2022

**Project Driver:**

Customer Service

**Specific Assumption Reference:**

Customer load request will be evaluated per Dominion’s Facility Interconnection Requirements Document and Dominion’s Transmission Planning Criteria.

**Problem Statement:**

NOVEC has submitted a DP Request for a new substation (Thunderball) in Loudoun County with a total load in excess of 100MW. Requested in-service date is 11/02/2024.

**Projected 2027 Load**

**Summer:** 124.0 MW

**Winter:** 153.0 MW

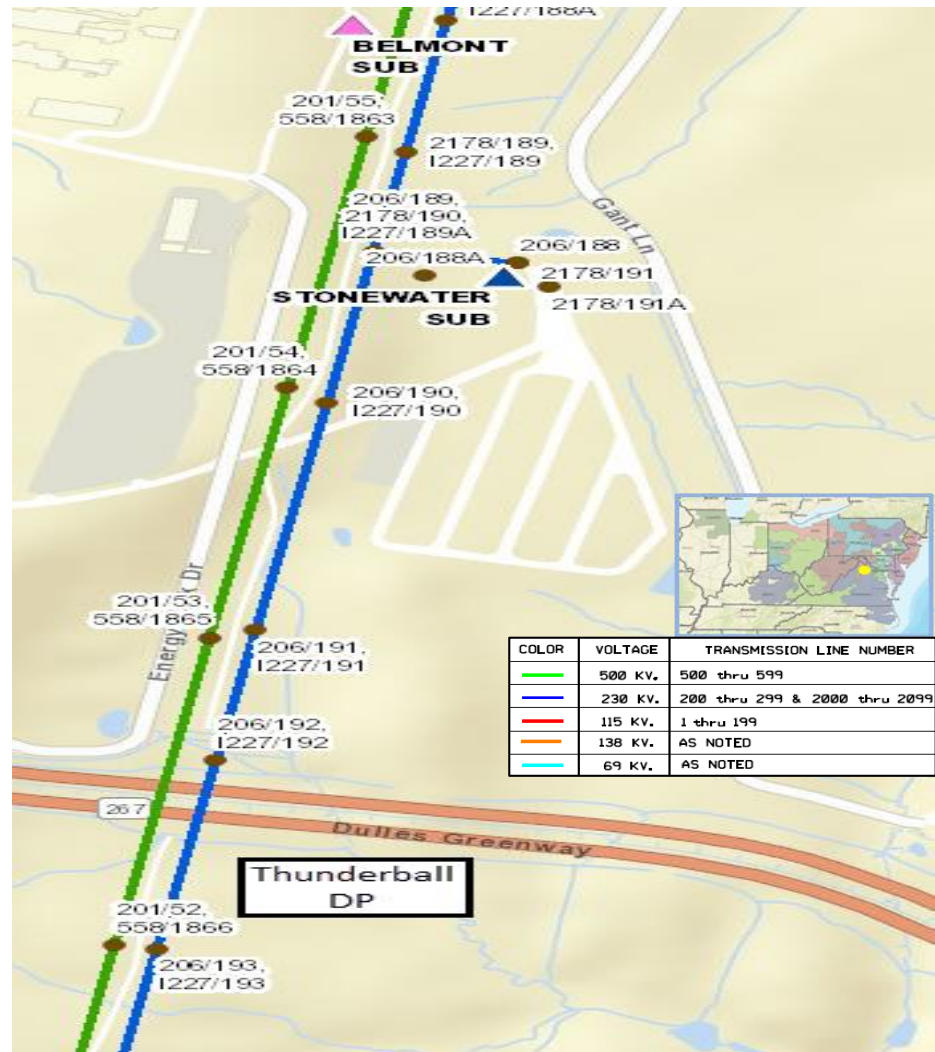



# Dominion Transmission Zone M-3 Process Thunderball 230kV Delivery - DEV

**Need Number:** DOM-2022-0036

**Process Stage:**

Submission of Supplemental Project for Inclusion in the Local Plan – 02/21/2024

**Selected Solution:**

Interconnect the new substation by cutting and extending Line #206 (Stonewater-Brambleton) to the proposed Thunderball Substation. Lines to terminate in a 230kV four-breaker ring arrangement with an ultimate arrangement of a six-breaker ring.

**Estimated Cost:** \$10.0M

**Projected In-Service:** 11/02/2024

**Supplemental Project ID:** s3025

**Project Status:** Construction

**Model:** 2025 RTEP

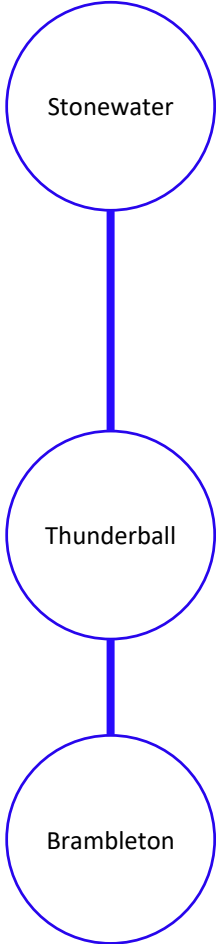

# Dominion Transmission Zone M-3 Process Trappe Rock 230kV Delivery - DEV

**Need Number:** DOM-2022-0037

**Process Stage:**

Submission of Supplemental Project for Inclusion in the Local Plan – 02/21/2024

**Previously Presented:**

Need – 06/07/2022

Solution – 07/12/2022

**Project Driver:**

Customer Service

**Specific Assumption Reference:**

Customer load request will be evaluated per Dominion’s Facility Interconnection Requirements Document and Dominion’s Transmission Planning Criteria.

**Problem Statement:**

NOVEC has submitted a DP Request for a new substation (Trappe Rock) in Loudoun County with a total load in excess of 100MW. Requested in-service date is 9/02/2024.

**Projected 2027 Load**

**Summer:** 90.0 MW

**Winter:** 153.0 MW

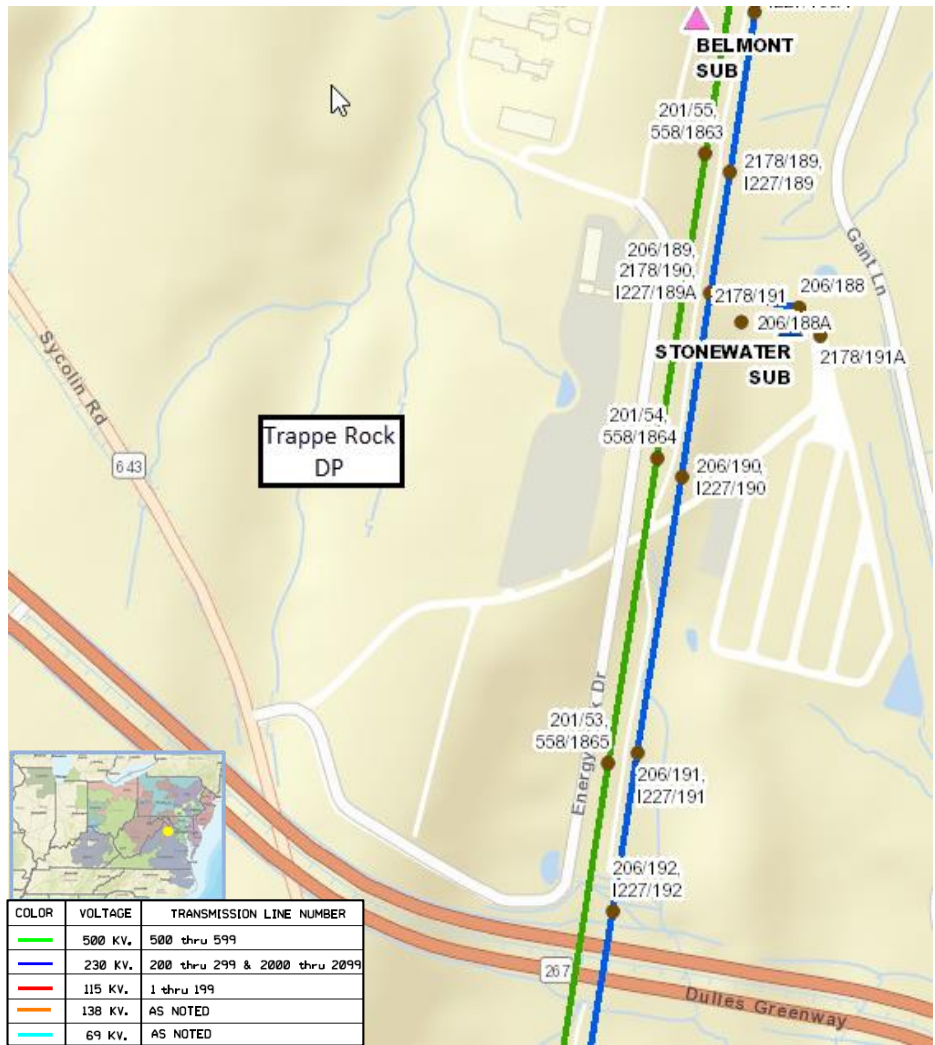

# Dominion Transmission Zone M-3 Process Trappe Rock 230kV Delivery - DEV

**Need Number:** DOM-2022-0037

**Process Stage:**

Submission of Supplemental Project for Inclusion in the Local Plan – 02/21/2024

**Selected Solution:**

Interconnect the new substation by cutting and extending Line #201 (Belmont-Altair) to the proposed Trappe Rock Substation. Lines to terminate in a 230kV four-breaker ring arrangement with an ultimate arrangement of a six-breaker ring.

**Estimated Cost:** \$10.0M

**Projected In-Service:** 09/02/2024

**Supplemental Project ID:** s3026

**Project Status:** Construction

**Model:** 2025 RTEP

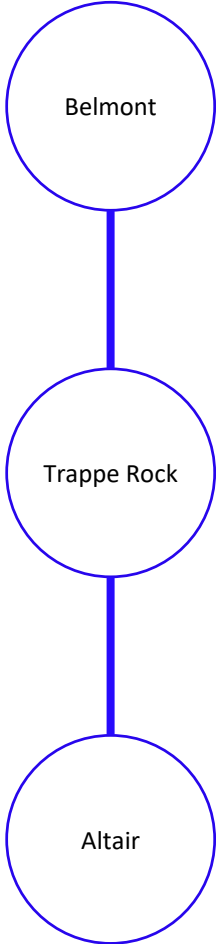

# Dominion Transmission Zone M-3 Process White Oak 230kV Delivery - DEV

**Need Number:** DOM-2022-0038

**Process Stage:**

Submission of Supplemental Project for Inclusion in the Local Plan – 02/21/2024

**Previously Presented:**

Need – 07/12/2022

Solution – 08/09/2022

**Project Driver:**

Customer Service

**Specific Assumption Reference:**

Customer load request will be evaluated per Dominion’s Facility Interconnection Requirements Document and Dominion’s Transmission Planning Criteria.

**Problem Statement:**

DEV Distribution has submitted a delivery point request at White Oak Substation to serve a data center customer in Henrico, VA. The total load is in excess of 100 MW. The customer requests service by March 1, 2023.

**Projected 2027 Load**

**Summer:** 146.5 MW

**Winter:** 136.5 MW

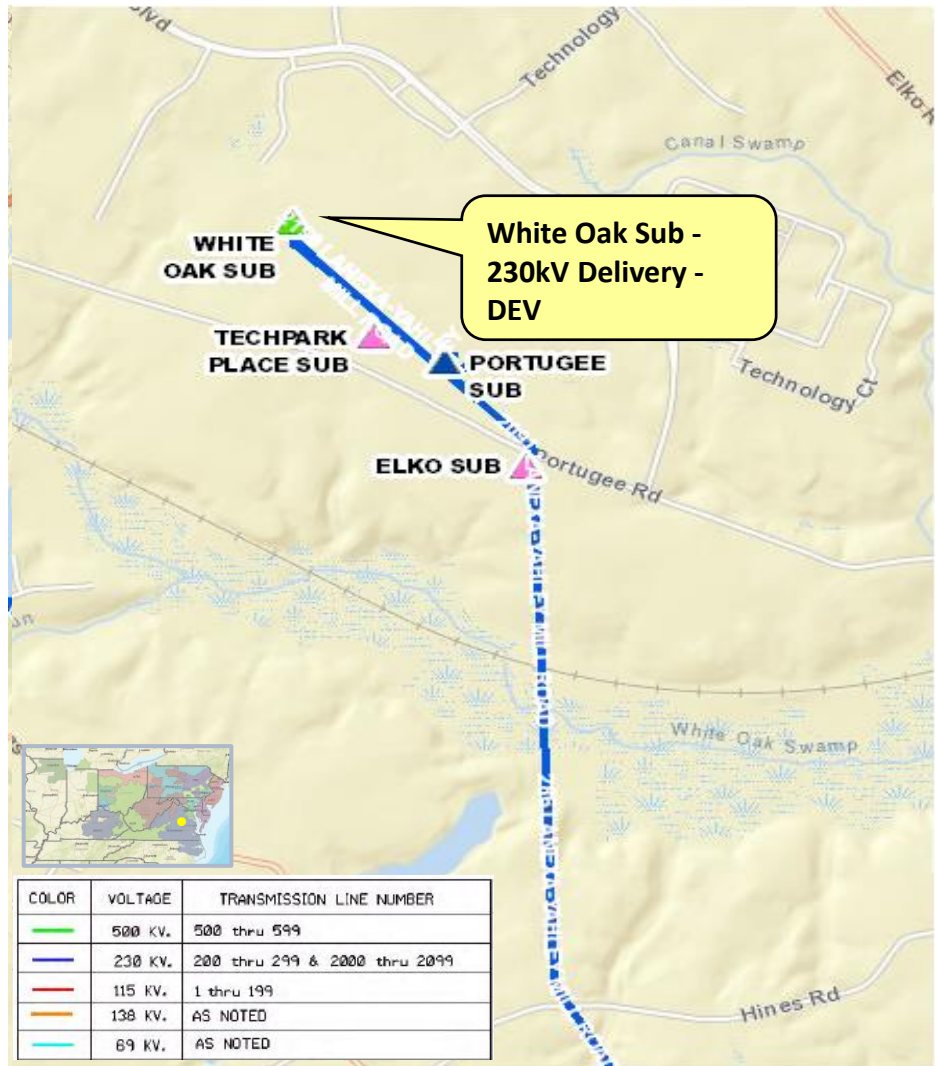

# Dominion Transmission Zone M-3 Process

## White Oak 230kV Delivery - DEV

**Need Number:** DOM-2022-0038

**Process Stage:**

Submission of Supplemental Project for Inclusion in the Local Plan – 02/21/2024

**Selected Solution:**

**To Interconnect Customer Load: (s3030.1)**

- Install equipment and bus work to support the installation of 2-56 MVA distribution transformers.

**To Resolve DNH 300 MW N-1-1 Load Drop Violation: (s3030.2)**

- Cut Line #2075 and extend double circuit 230kV lines into White Oak Substation. Install 2-1200 Amp switches and upgrade bus work and existing equipment at the White Oak Substation. Add 3 additional 230kV breakers to terminate 230kV lines.

**Estimated Cost:** \$30 M

**Projected In-Service:** March 2023 (to connect Distribution TX)  
Dec 2025 (to cut line #2075 into White Oak)

**Supplemental Project ID:** s3030.1, s3030.2

**Project Status:** Engineering

**Model:** 2025 RTEP

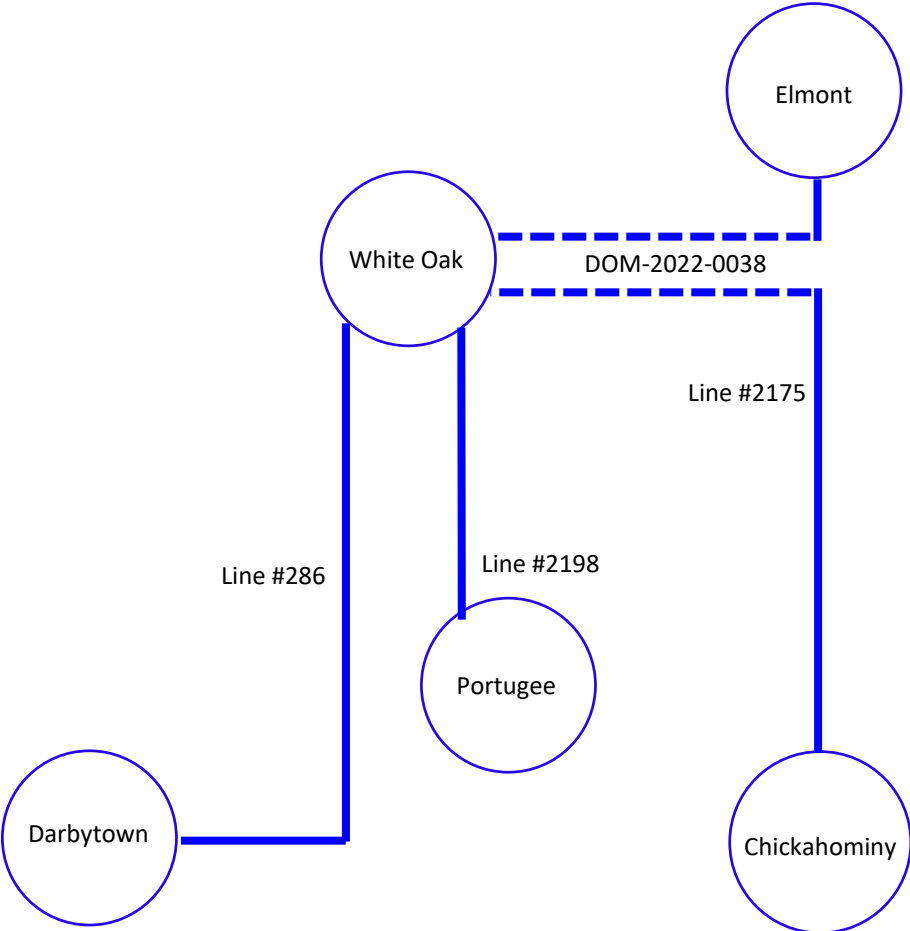

# Dominion Transmission Zone M-3 Process Techpark Place 230kV Delivery - DEV

**Need Number:** DOM-2022-0039

**Process Stage:**

Submission of Supplemental Project for Inclusion in the Local Plan – 02/21/2024

**Previously Presented:**

Need – 07/12/2022

Solution – 08/09/2022

**Project Driver:**

Customer Service

**Specific Assumption Reference:**

Customer load request will be evaluated per Dominion’s Facility Interconnection Requirements Document and Dominion’s Transmission Planning Criteria.

**Problem Statement:**

DEV Distribution has submitted a new delivery point request for Techpark Place (TPP) Substation to serve a data center customer in Henrico, VA. The total load is in excess of 100 MW. The customer requests service by January 1, 2024.

**Projected 2027 Load**

**Summer:** 283.6 MW

**Winter:** 283.6 MW

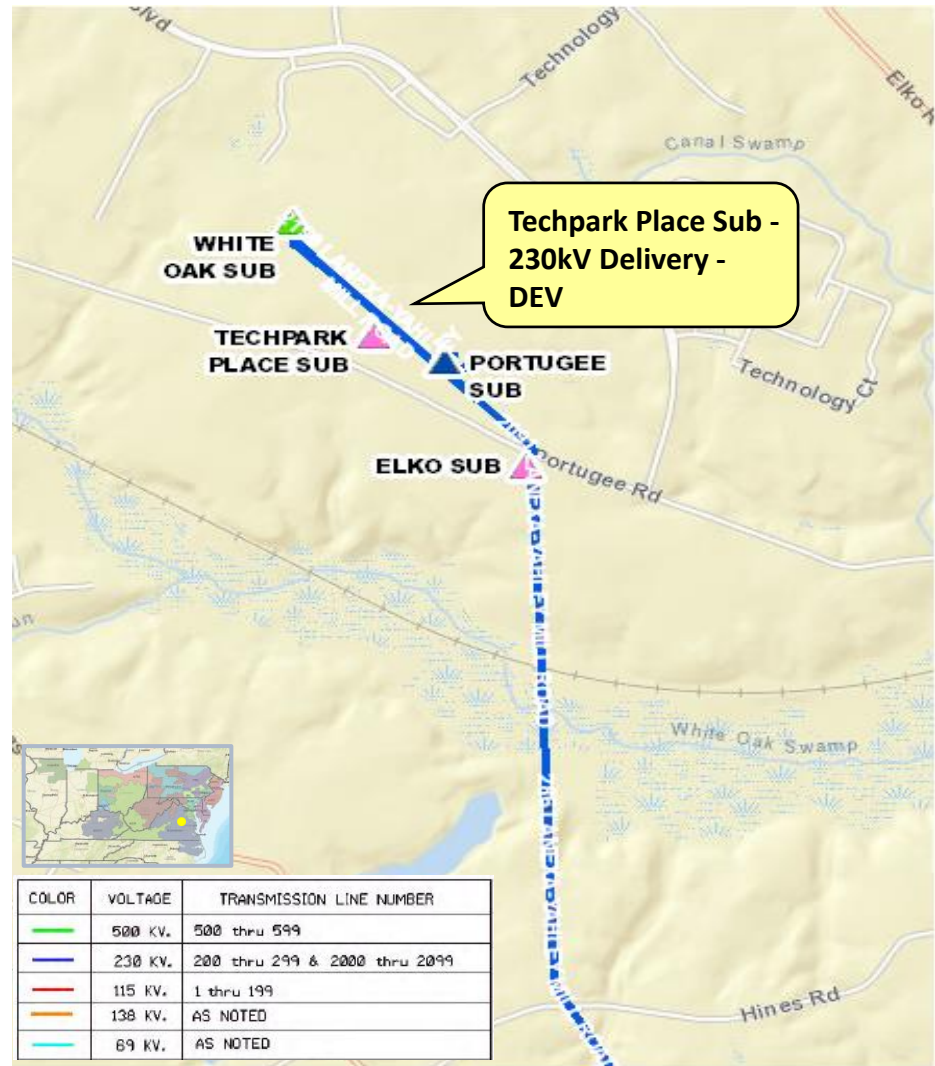

# Dominion Transmission Zone M-3 Process Techpark Place 230kV Delivery - DEV

**Need Number:** DOM-2022-0039

**Process Stage:**

Submission of Supplemental Project for Inclusion in the Local Plan – 02/21/2024

**Selected Solution:**

Cut Line #286 (Darbytown-White Oak) and Line #2198 (Portugee-White Oak) and terminate at new TPP Substation in a 6-breaker 230kV ring bus. Include associated equipment (bus, switches, relays, etc.) as required.

**Estimated Cost:** \$25 M

**Projected In-Service:** 04/01/2024

**Supplemental Project ID:** s3031

**Project Status:** Construction

**Model:** 2025 RTEP

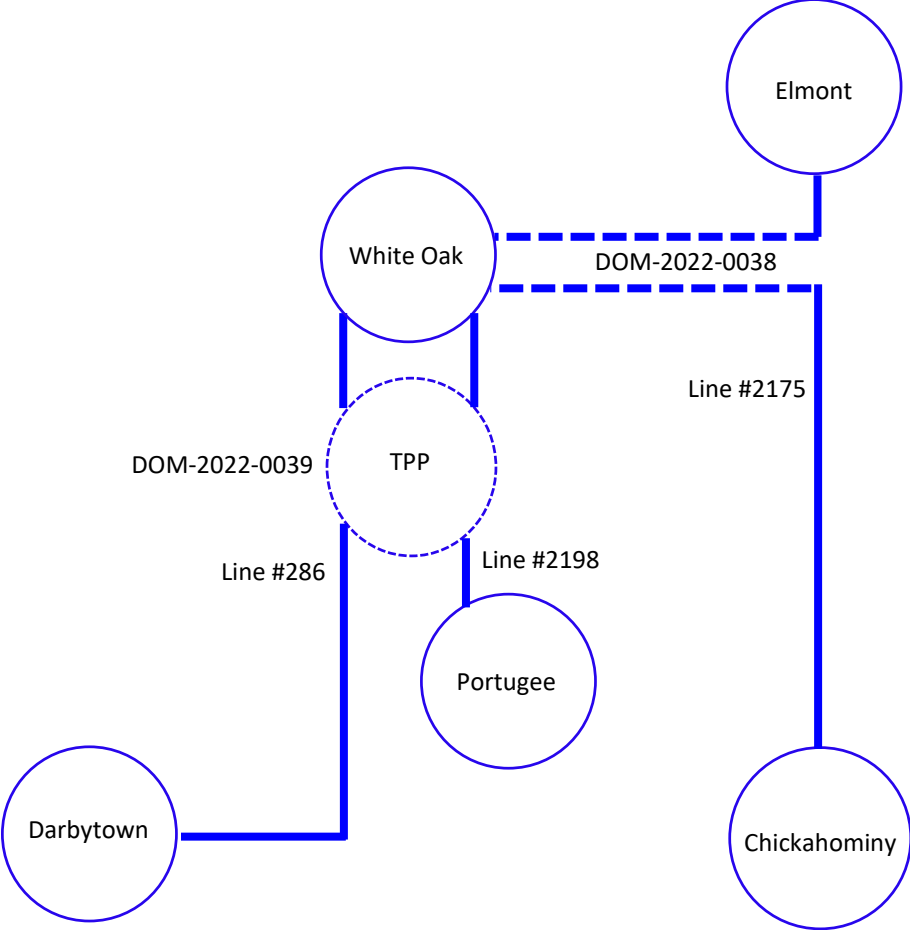

# Dominion Transmission Zone M-3 Process

## Farmwell - Add 4<sup>th</sup> TX - DEV

**Need Number:** DOM-2022-0040

**Process Stage:**

Submission of Supplemental Project for Inclusion in the Local Plan – 02/21/2024

**Previously Presented:**

Need – 06/07/2022

Solution – 08/09/2022

**Project Driver:**

Customer Service

**Specific Assumption Reference:**

Customer load request will be evaluated per Dominion’s Facility Interconnection Requirements Document and Dominion’s Transmission Planning Criteria.

**Problem Statement:**

DEV Distribution has submitted a DP Request to add a 4<sup>th</sup> distribution transformer at Farmwell Substation in Loudoun County. The new transformer is being driven by continued load growth in the area and contingency loading for loss of one of the existing transformers. Requested in-service date is 08/01/2023.

**Projected 2027 Load**

**Summer:** 292.0 MW

**Winter:** 292.0 MW

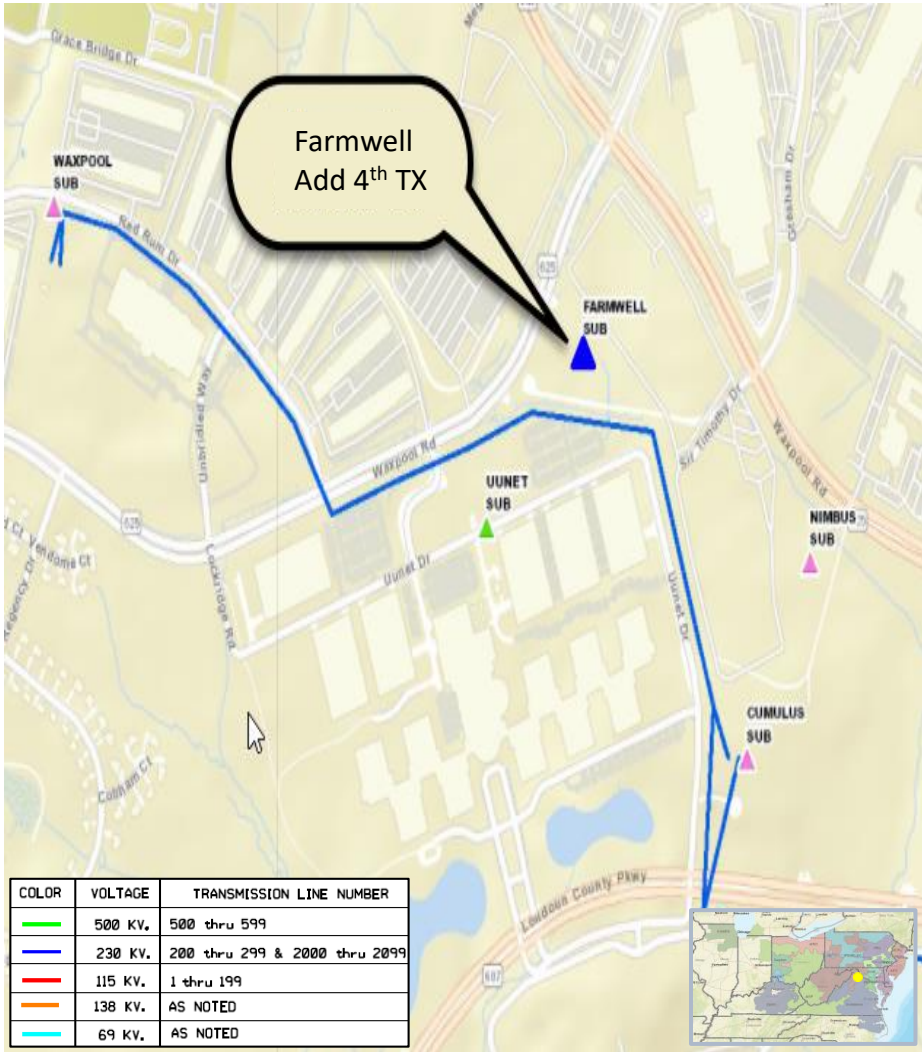



# Dominion Transmission Zone M-3 Process

## Farmwell - Add 4<sup>th</sup> TX - DEV

**Need Number:** DOM-2022-0040

**Process Stage:**

Submission of Supplemental Project for Inclusion in the Local Plan – 02/21/2024

**Selected Solution:**

Install a 1200 Amp, 50kAIC circuit switcher and associated equipment (bus, relaying, etc.) to feed the new transformer at Farmwell.

**Estimated Cost:** \$0.5M

**Projected In-Service:** 03/28/2024

**Supplemental Project ID:** s3032

**Project Status:** Construction

**Model:** 2025 RTEP

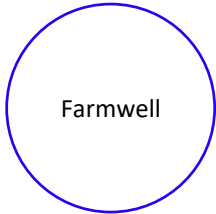

# Dominion Transmission Zone M-3 Process Stratus 230kV Delivery - DEV

**Need Number:** DOM-2022-0041

**Process Stage:**

Submission of Supplemental Project for Inclusion in the Local Plan – 02/21/2024

**Previously Presented:**

Need – 06/07/2022

Solution – 08/09/2022

**Project Driver:**

Customer Service

**Specific Assumption Reference:**

Customer load request will be evaluated per Dominion’s Facility Interconnection Requirements Document and Dominion’s Transmission Planning Criteria.

**Problem Statement:**

DEV has submitted a DP Request for a new substation (Stratus) in Loudoun County with a total load in excess of 100MW. Requested in-service date is 12/31/2024.

**Projected 2027 Load**

**Summer:** 185.0 MW

**Winter:** 167.0 MW

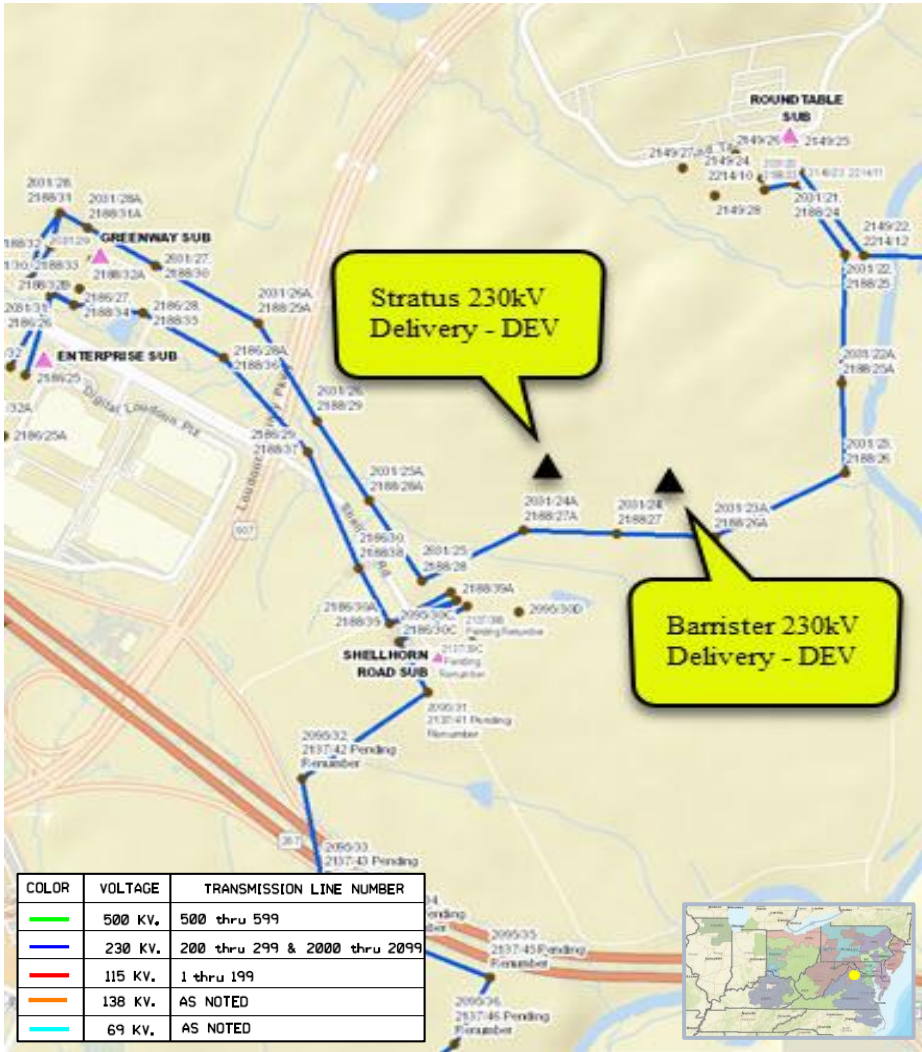

# Dominion Transmission Zone M-3 Process Stratus 230kV Delivery - DEV

**Need Number:** DOM-2022-0041

**Process Stage:**

Submission of Supplemental Project for Inclusion in the Local Plan – 02/21/2024

**Selected Solution:**

Interconnect the new substation by cutting and extending Line #2188 (Lockridge-Shellhorn) and Line #2031 (Roundtable-Enterprise) into the proposed Stratus Substation. Terminate both ends into a six-breaker ring bus arrangement to create Roundtable-Stratus, Stratus-Shellhorn, Enterprise-Stratus, and Lockridge-Stratus lines.

Need Number DOM-2022-0001 (Barrister 230kV Delivery – DEV) will be adjacent to Stratus Substation.

**Estimated Cost:** \$24.0M (Total)

Stratus Substation	\$10.0M
Line Extension	\$ 2.0M
Stratus Land Purchase	\$12.0M

**Projected In-Service:** 08/29/2025

**Supplemental Project ID:** s3033

**Project Status:** Engineering

**Model:** 2025 RTEP

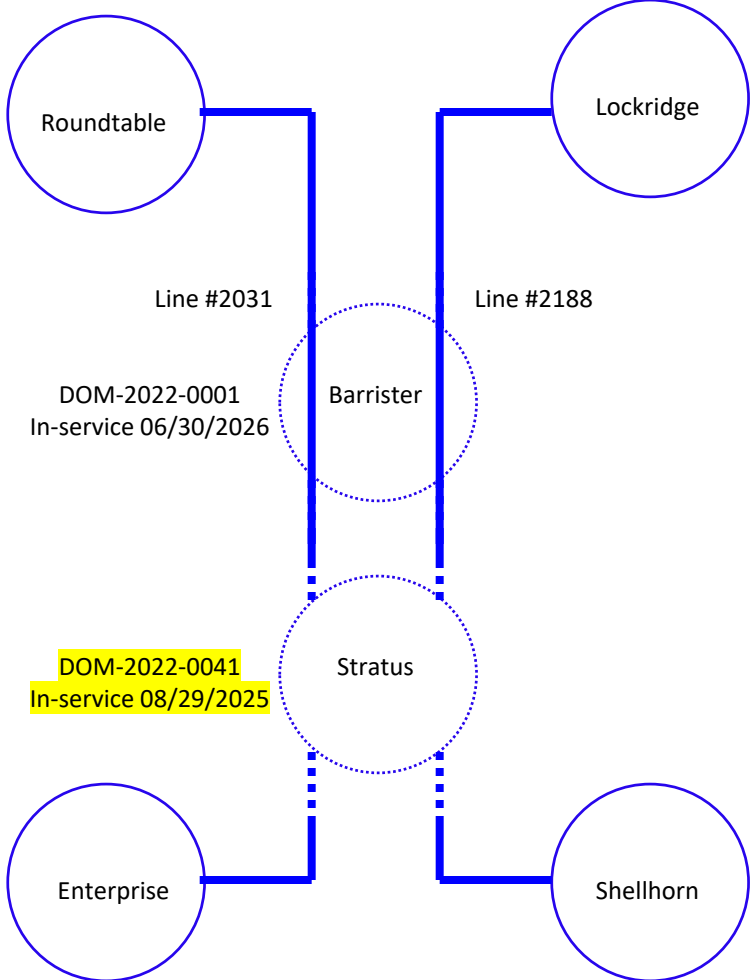

# Dominion Transmission Zone M-3 Process Lockridge – Add 3 TX's - DEV

**Need Number:** DOM-2022-0044

**Process Stage:**

Submission of Supplemental Project for Inclusion in the Local Plan – 02/21/2024

**Previously Presented:**

Need – 06/07/2022

Solution – 08/09/2022

**Project Driver:**

Customer Service

**Specific Assumption Reference:**

Customer load request will be evaluated per Dominion’s Facility Interconnection Requirements Document and Dominion’s Transmission Planning Criteria.

**Problem Statement:**

DEV Distribution has submitted a DP Request to add a three additional distribution transformers at Lockridge Substation in Loudoun County. The new transformers are being driven by continued load growth in the area and contingency loading for loss of one of the existing transformers. Requested in-service date is 01/01/2023.

**Projected 2027 Load**

**Summer:** 288.0 MW

**Winter:** 288.0 MW

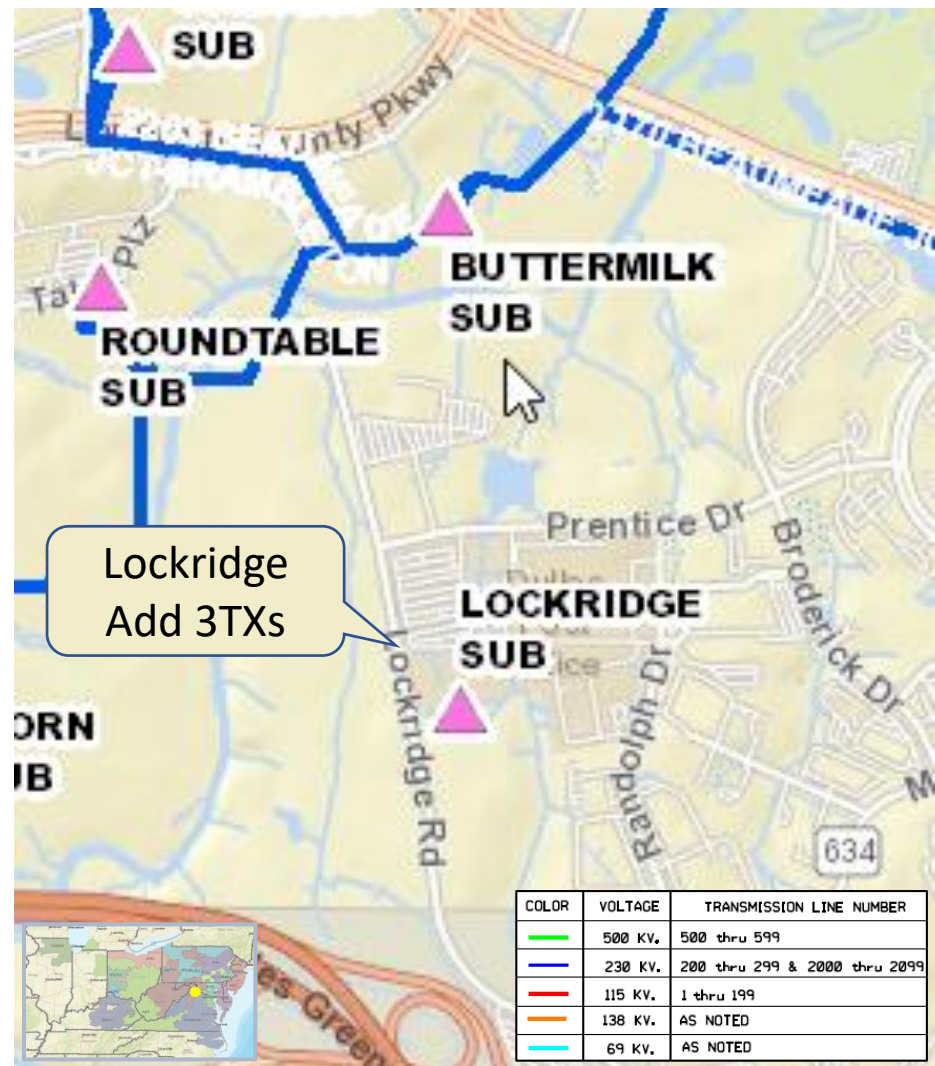

# Dominion Transmission Zone M-3 Process Lockridge – Add 3 TX's - DEV

**Need Number:** DOM-2022-0044

**Process Stage:**

Submission of Supplemental Project for Inclusion in the Local Plan – 02/21/2024

**Selected Solution:**

Install three 1200 Amp, 50kAIC circuit switchers and associated equipment (bus, relaying, etc.) to feed the three new transformers at Lockridge.

**Estimated Cost:** \$1.5M

**Projected In-Service:** 02/28/2024

**Supplemental Project ID:** s3034

**Project Status:** Construction

**Model:** 2025 RTEP

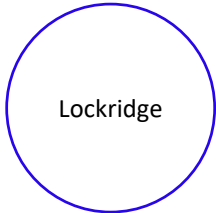

# Dominion Transmission Zone M-3 Process Hornbaker 230kV Delivery - NOVEC

**Need Number:** DOM-2022-0045

**Process Stage:**

Submission of Supplemental Project for Inclusion in the Local Plan – 02/21/2024

**Previously Presented:**

Need – 07/12/2022

Solution – 08/09/2022

**Project Driver:**

Customer Service

**Specific Assumption Reference:**

Customer load request will be evaluated per Dominion’s Facility Interconnection Requirements Document and Dominion’s Transmission Planning Criteria.

**Problem Statement:**

NOVEC has submitted a DP Request for a new substation (Hornbaker) to serve a data center complex in Prince William County with a total load in excess of 100 MW. Requested in-service date is 12/30/2025.

**Projected 2027 Load**

**Summer:** 150.0 MW

**Winter:** 150.0 MW

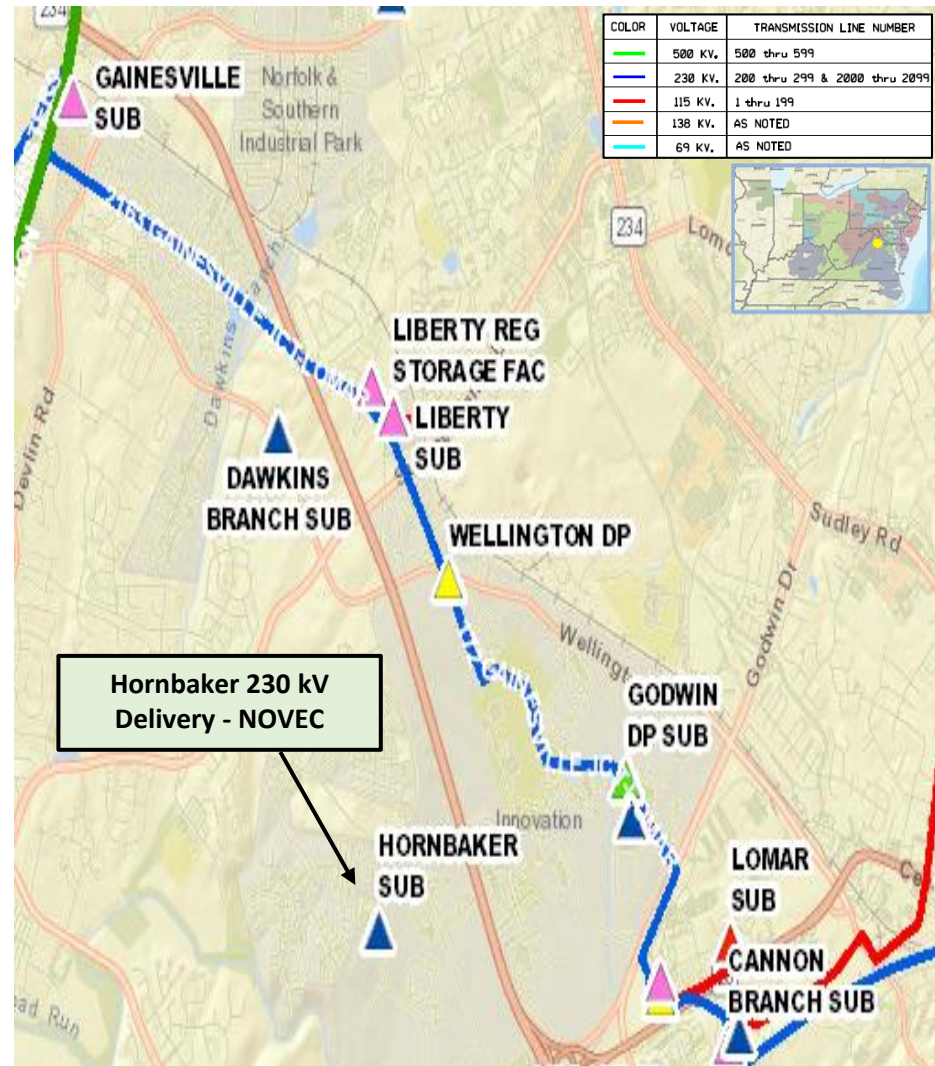

# Dominion Transmission Zone M-3 Process Hornbaker 230kV Delivery - NOVEC

**Need Number:** DOM-2022-0045

**Process Stage:**

Submission of Supplemental Project for Inclusion in the Local Plan – 02/21/2024

**Selected Solution:**

Interconnect the new substation by cutting and extending Line #2187 (Liberty - Pioneer) to the proposed Hornbaker Substation. Lines to terminate into a 230 kV four-breaker ring arrangement with an ultimate arrangement of a six-breaker ring.

<b>Estimated Cost:</b>	\$45.0M (Total)
Transmission Line	\$ 8.0M
Real Estate	\$25.0M
Substation	\$12.0M

**Projected In-Service:** 12/30/2025

**Supplemental Project ID:** s3035.1

**Project Status:** Engineering

**Model:** 2025 RTEP

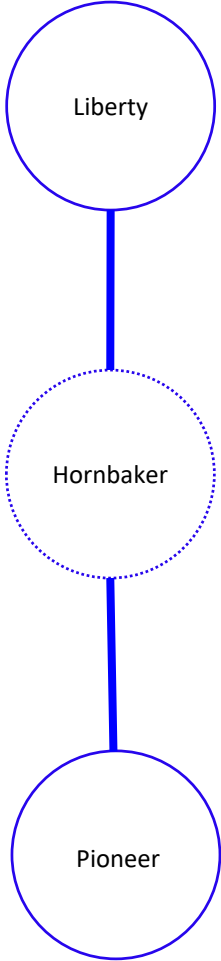

# Dominion Transmission Zone M-3 Process Do No Harm (DNH) Analysis

**Need Number:** DOM-2022-0045-DNH

**Process Stage:**  
Submission of Supplemental Project for Inclusion in the Local Plan – 02/21/2024

**Presentation Date:**  
DNH – 08/09/2022

**Supplemental Project Driver:**  
Do No Harm Analysis

**Specific Assumption Reference:**  
Customer load request will be evaluated per Dominion’s Facility Interconnection Requirements Document and Dominion’s Transmission Planning Criteria.

**Problem Statement:**  
PJM has identified N-1-1 thermal violations on the following separate facilities in the 2022 Do-No-Harm analysis:

- Line #2163 (Dawkins Branch to Vint Hill)
  - Contingency Scenario: DVP\_P:1-2: LN 2151 and DVP\_P:1-2: LN 2011
- Line #2151 (Railroad to Gainesville)
  - Contingency Scenario: DVP\_P:1-2: LN 2163 and DVP\_P:1-2: LN 2011
- Line #2101 (Vint Hill to Nokesville Segment)
  - Contingency Scenarios: DVP\_P:1-2: LN 2151 and DVP\_P:1-2: LN 2011
- Line #2011 (Clifton to Brickyard Segment)
  - Contingency Scenario: DVP\_P:1-2: LN 2151 and DVP\_P:1-2: LN 2163

The violations are caused by previously presented Supplemental Project DOM-2022-0045 in the Dominion Zone.

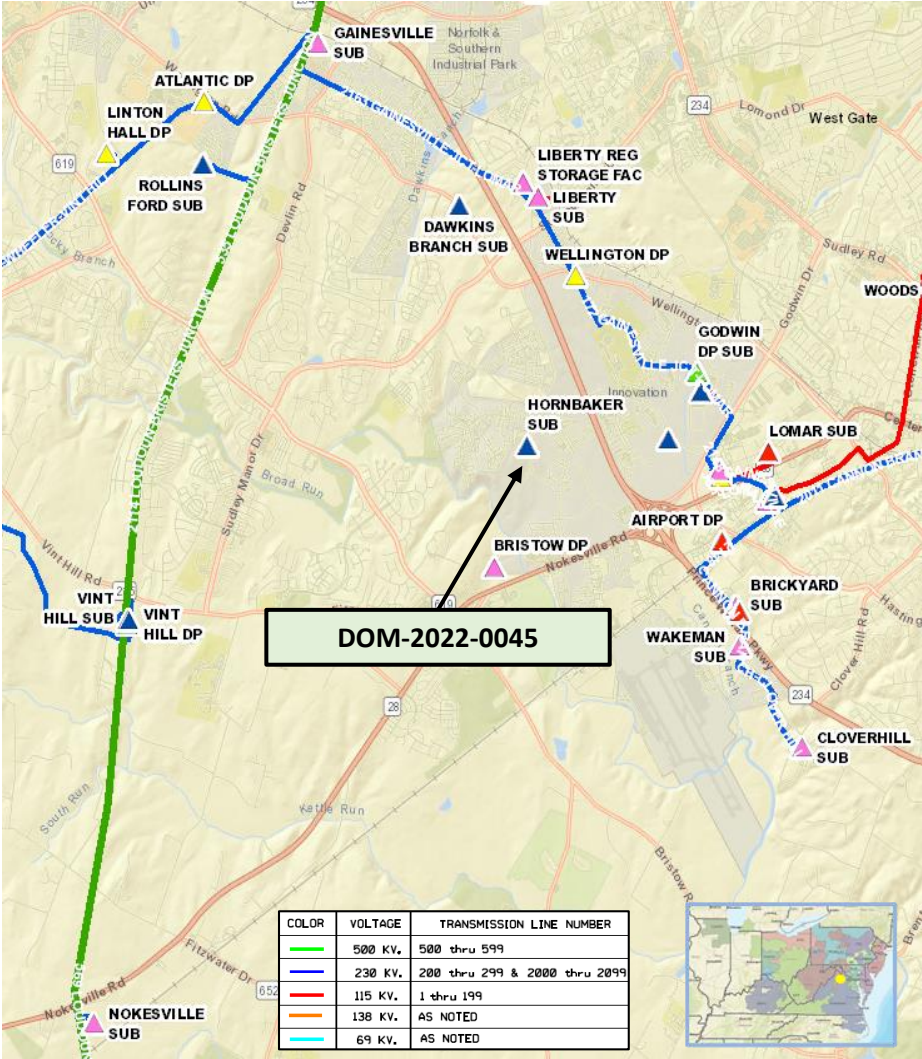



# Dominion Transmission Zone M-3 Process Do No Harm (DNH) Analysis

**Need Number:** DOM-2022-0045-DNH

**Process Stage:**

Submission of Supplemental Project for Inclusion in the Local Plan – 02/21/2024

**Selected Solution:**

- Construct one new 230 kV transmission line for approximately 7.5 miles from Hornbaker to Nokesville Substation with a minimum summer normal conductor rating of 1573 MVA. New right-of-way and expansion of existing right-of-way will be required.
- Install a 230 kV ring bus and associated 230 kV equipment (breakers, switches, leads) at the existing Nokesville Substation.
- Re-configure the existing terminations of line #2101 (Bristers – Vint Hill) into Nokesville Substation to accommodate the new 230 kV line.

<b>Estimated Cost:</b>	\$139.0M (Total)
Transmission Line	\$45.0M
Real Estate	\$82.5M
Substation	\$11.5M

**Projected In-Service:** 12/31/2027

**Supplemental Project ID:** s3035.2

**Project Status:** Conceptual

**Model:** 2025 RTEP

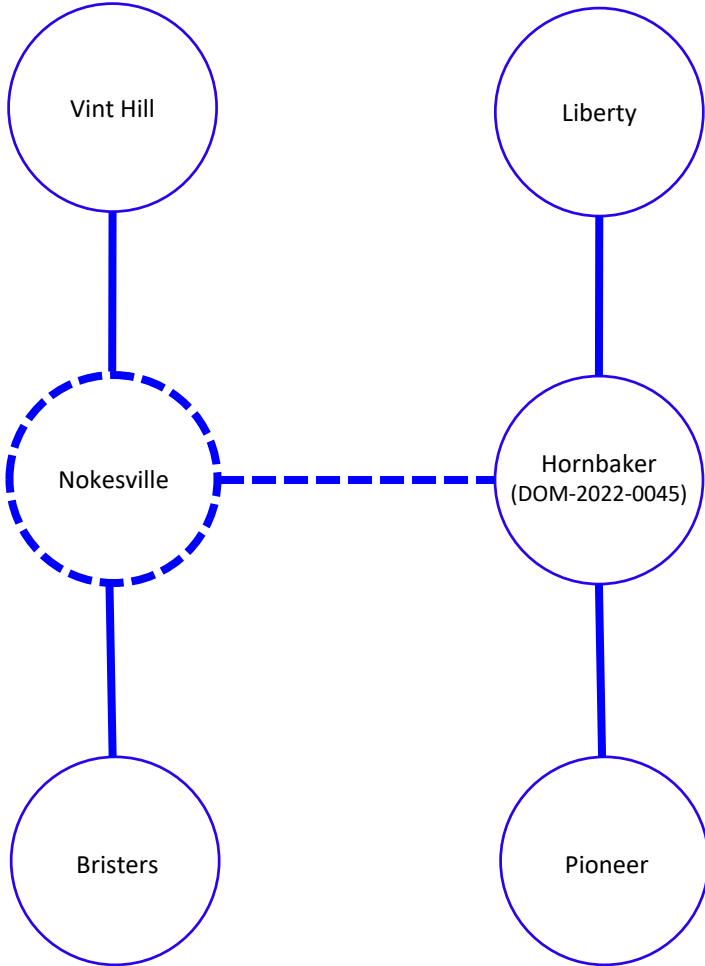

# Dominion Transmission Zone M-3 Process Mint Springs 230kV Delivery - NOVEC

**Need Number:** DOM-2022-0046

**Process Stage:**

Submission of Supplemental Project for Inclusion in the Local Plan – 02/21/2024

**Previously Presented:**

Need – 07/12/2022

Solution – 08/09/2022

**Project Driver:**

Customer Service

**Specific Assumption Reference:**

Customer load request will be evaluated per Dominion’s Facility Interconnection Requirements Document and Dominion’s Transmission Planning Criteria.

**Problem Statement:**

NOVEC has submitted a DP Request for a new substation (Mint Springs) to serve a data center complex in Prince William County with a total load in excess of 100 MW. Requested in-service date is 01/02/2026.

**Projected 2027 Load**

**Summer:** 50.0 MW

**Winter:** 50.0 MW

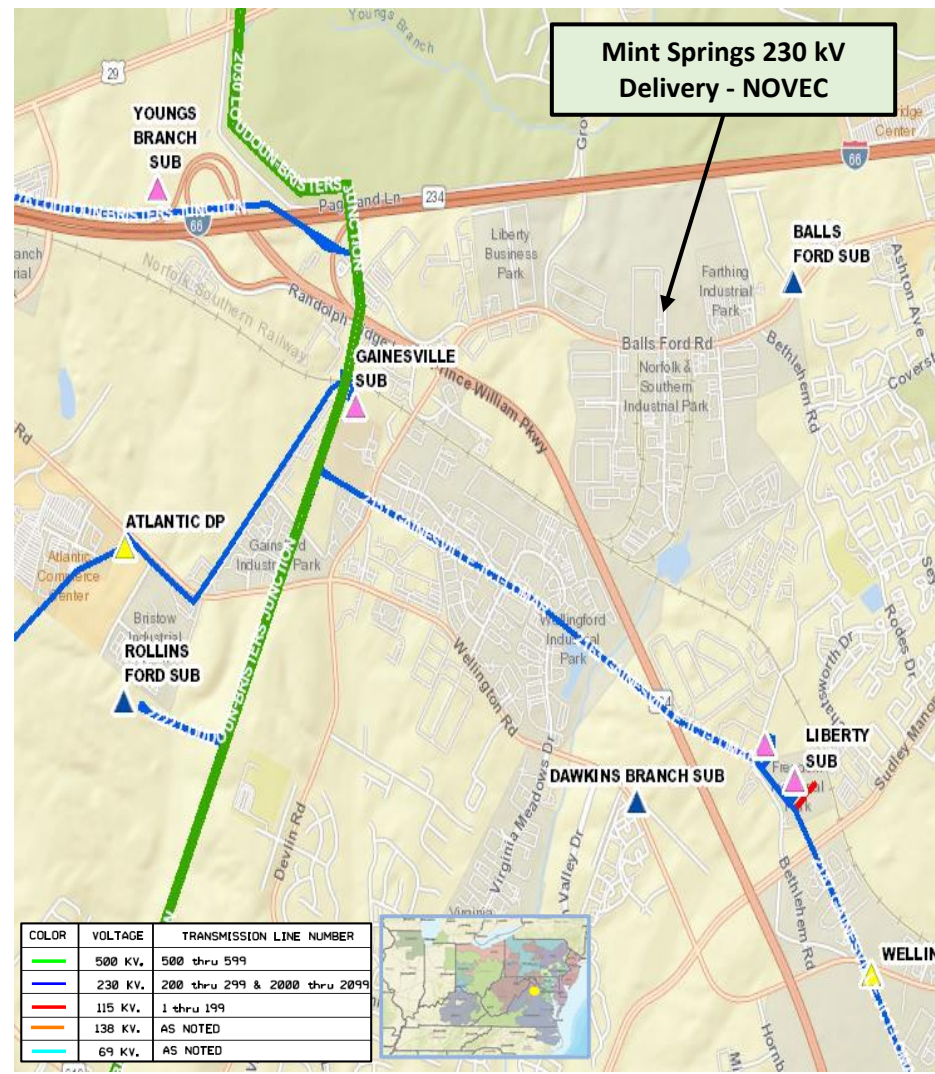

# Dominion Transmission Zone M-3 Process Mint Springs 230kV Delivery - NOVEC

**Need Number:** DOM-2022-0046

**Process Stage:**

Submission of Supplemental Project for Inclusion in the Local Plan – 02/21/2024

**Selected Solution:**

Interconnect the new substation by cutting and extending Line #2030 (Loudoun - Gainesville) to the proposed Mint Springs Substation. Lines to terminate into a 230 kV four-breaker ring arrangement with an ultimate arrangement of a six-breaker ring.

**Estimated Cost:** \$16.0M

**Projected In-Service:** 01/02/2026

**Supplemental Project ID:** s3036

**Project Status:** Engineering

**Model:** 2025 RTEP

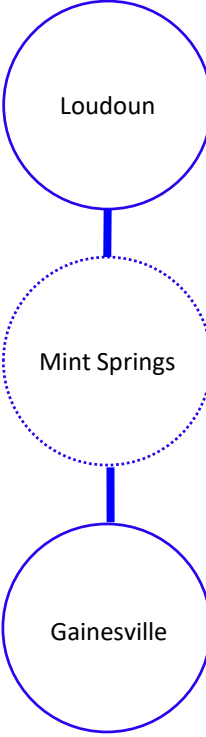

# Dominion Transmission Zone M-3 Process Rixlew 230kV Delivery - NOVEC

**Need Number:** DOM-2022-0047

**Process Stage:**

Submission of Supplemental Project for Inclusion in the Local Plan – 02/21/2024

**Previously Presented:**

Need – 07/12/2022

Solution – 08/09/2022

**Project Driver:**

Customer Service

**Specific Assumption Reference:**

Customer load request will be evaluated per Dominion’s Facility Interconnection Requirements Document and Dominion’s Transmission Planning Criteria.

**Problem Statement:**

NOVEC has submitted a DP Request for a new substation (Rixlew) to serve a data center complex in Manassas with a total load in excess of 100 MW. Requested in-service date is 12/31/2024.

**Projected 2027 Load**

**Summer:** 95.0 MW

**Winter:** 103.0 MW

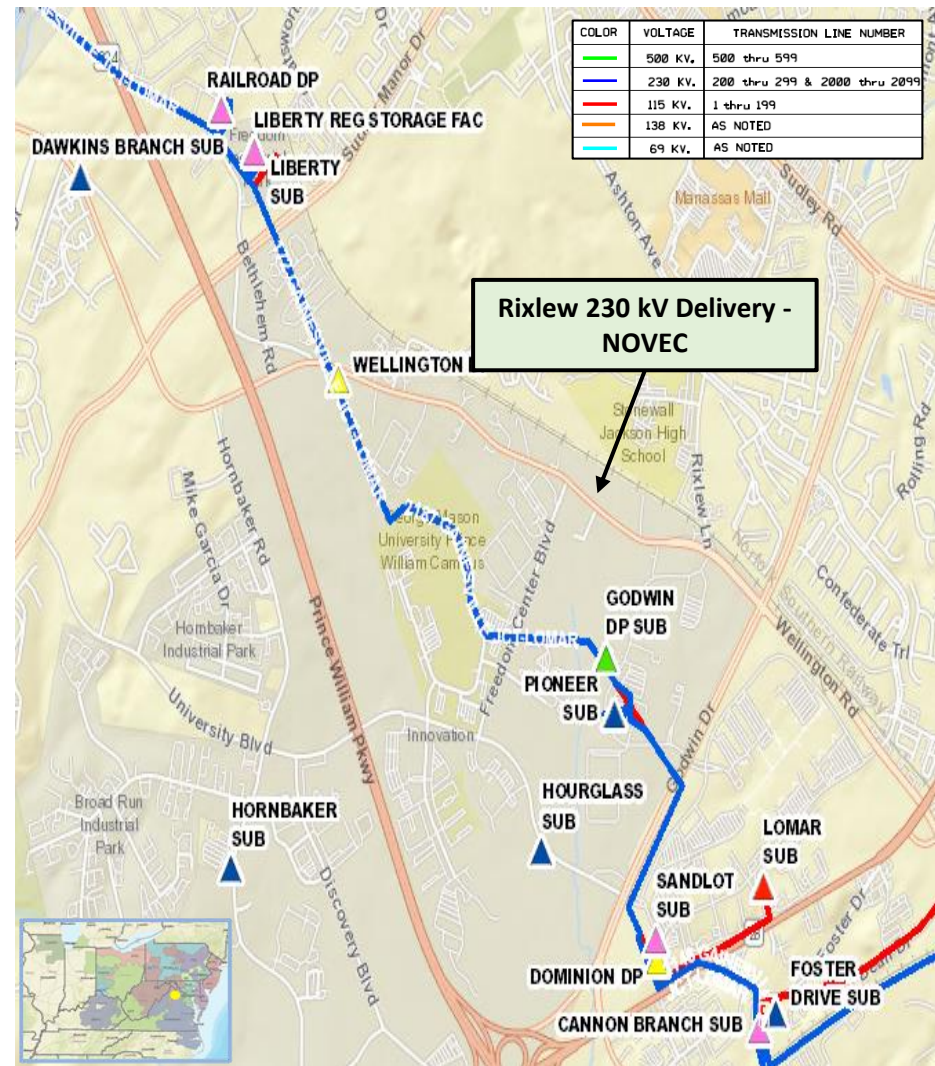

# Dominion Transmission Zone M-3 Process Rixlew 230kV Delivery - NOVEC

**Need Number:** DOM-2022-0047

**Process Stage:**

Submission of Supplemental Project for Inclusion in the Local Plan – 02/21/2024

**Selected Solution:**

Interconnect the new substation by cutting and extending Line #2228 (Liberty - Pioneer) to the proposed Rixlew Substation. Lines to terminate into a 230 kV four-breaker ring arrangement with an ultimate arrangement of a six-breaker ring.

**Estimated Cost:** \$10.0M

**Projected In-Service:** 06/20/2025

**Supplemental Project ID:** s3037

**Project Status:** Engineering

**Model:** 2025 RTEP

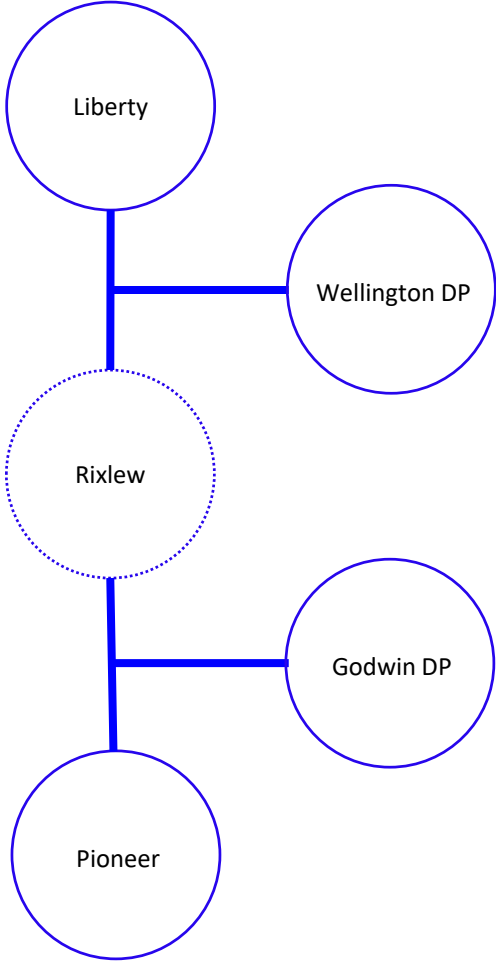

# Dominion Transmission Zone M-3 Process Do No Harm (DNH) Analysis

**Need Number:** DOM-2022-0001-DNH & DOM-2022-0041-DNH  
**Process Stage:**  
 Submission of Supplemental Project for Inclusion in the Local Plan – 02/21/2024

**Presentation Date:**  
 DNH – 09/06/2022

**Supplemental Project Driver:**  
 Do No Harm Analysis

**Specific Assumption Reference:**  
 Customer load request will be evaluated per Dominion’s Facility Interconnection Requirements Document and Dominion’s Transmission Planning Criteria.

**Problem Statement:**  
 PJM has identified N-1-1 thermal violations on the following facility in the 2022 Do-No-Harm analysis:

- Ox-Braddock Line
  - Contingency Scenario: DVP\_P1-2: LN 541 and DVP\_P1-2: LN 2022

The violations are caused by previously presented Supplemental Projects DOM-2022-0001 & DOM-2022-0041 in the Dominion Zone.

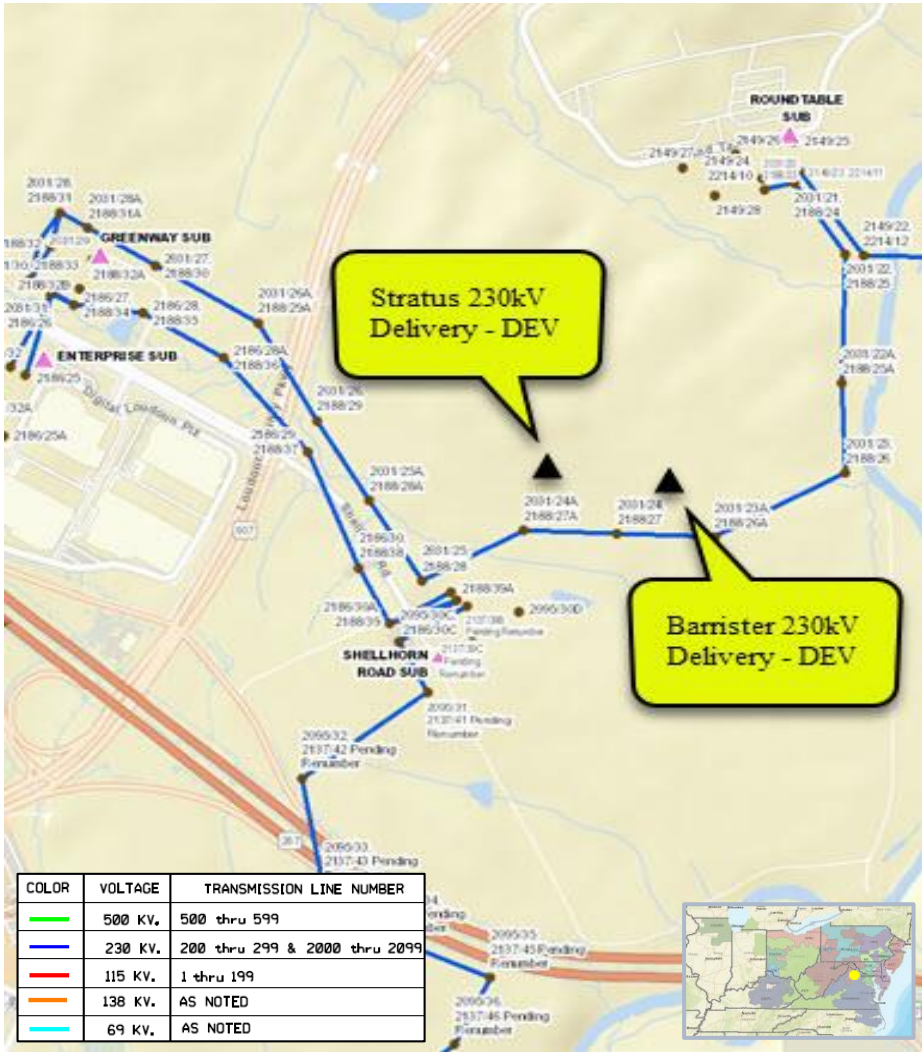

# Dominion Transmission Zone M-3 Process Do No Harm (DNH) Analysis

**Need Number:** DOM-2022-0001-DNH & DOM-2022-0041-DNH

**Process Stage:**  
Submission of Supplemental Project for Inclusion in the Local Plan – 02/21/2024

**Selected Solution:**  
Rebuild approx. 7.9 miles of double-circuit Line from Ox to Braddock and partial Line#2097 (Ox-Idylwood) to current 230kV standards. The normal summer rating of the line conductor will be 1573 MVA.

<b>Estimated Cost:</b>	\$43.5M (Total)
Transmission Line	\$37.0M
Substation	\$ 6.5M

**Projected In-Service:** 06/30/2027

**Supplemental Project ID:** s3040

**Project Status:** Conceptual

**Model:** 2025 RTEP

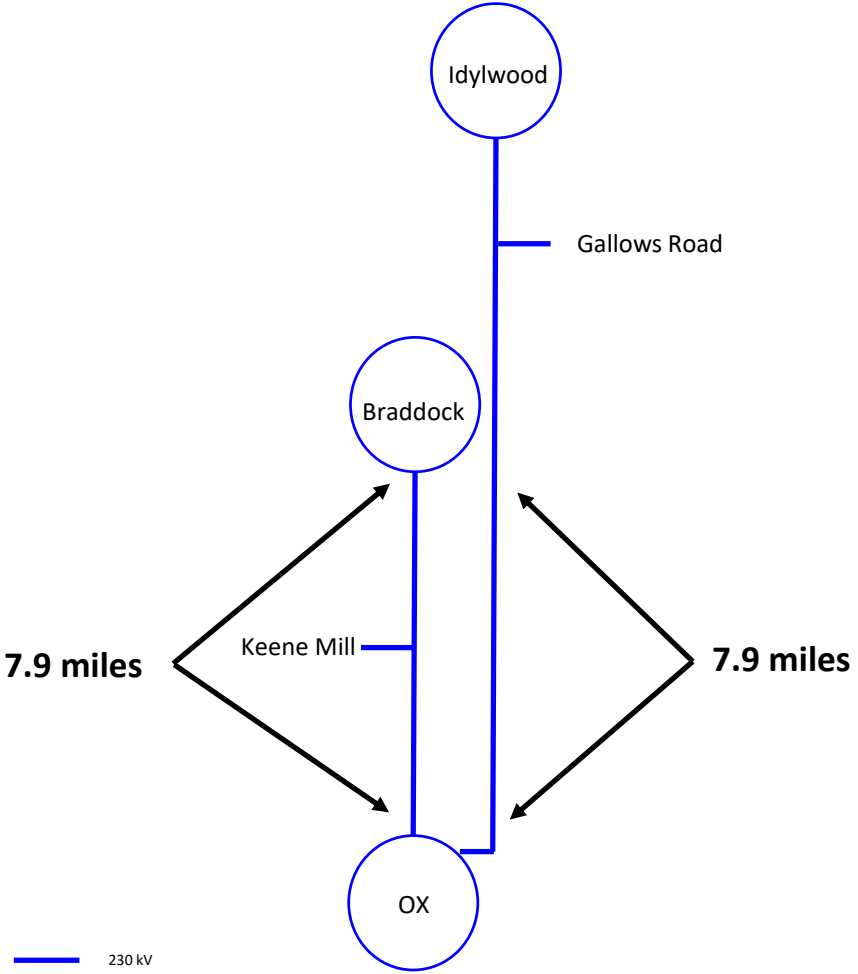

# Dominion Transmission Zone M-3 Process

## Prentice Drive 230kV Delivery - DEV

**Need Number:** DOM-2022-0003

**Process Stage:**

Submission of Supplemental Project for Inclusion in the Local Plan – 02/21/2024

**Previously Presented:**

Need – 06/07/2022

Solution – 08/08/2023

**Project Driver:**

Customer Service

**Specific Assumption Reference:**

Customer load request will be evaluated per Dominion’s Facility Interconnection Requirements Document and Dominion’s Transmission Planning Criteria.

**Problem Statement:**

DEV has submitted a DP Request for a new substation (Prentice) in Loudoun County with a total load in excess of 100MW. Requested in-service date is 12/30/2024.

**Projected 2028 Load**

**Summer:** 160.0 MW

**Winter:** 145.7 MW

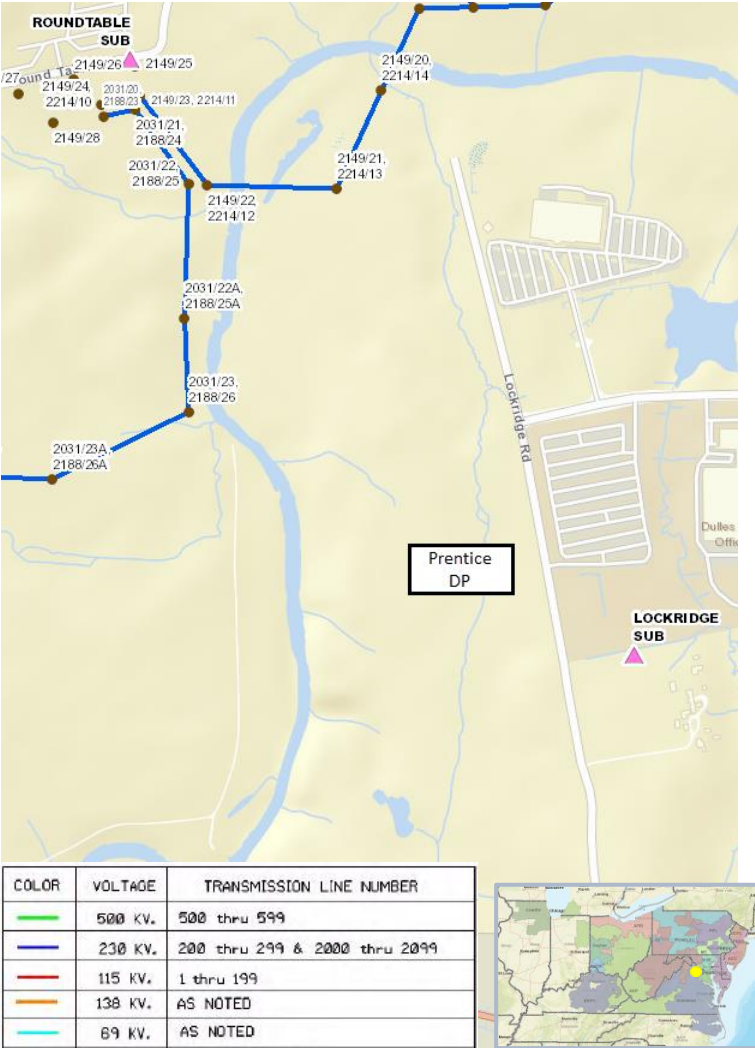



# Dominion Transmission Zone M-3 Process Prentice Drive 230kV Delivery - DEV

**Need Number:** DOM-2022-0003

**Process Stage:**

Submission of Supplemental Project for Inclusion in the Local Plan – 02/21/2024

**Selected Solution:**

Interconnect the new substation by cutting and extending Line #2188 (Lockridge – Shellhorn) to the proposed Prentice Drive Substation. Lines to terminate in a 230kV six-breaker ring arrangement.

**Estimated Cost:** \$20.0 M

**Projected In-Service:** 12/30/2024

**Supplemental Project ID:** s3056

**Project Status:** Engineering

**Model:** 2027 RTEP

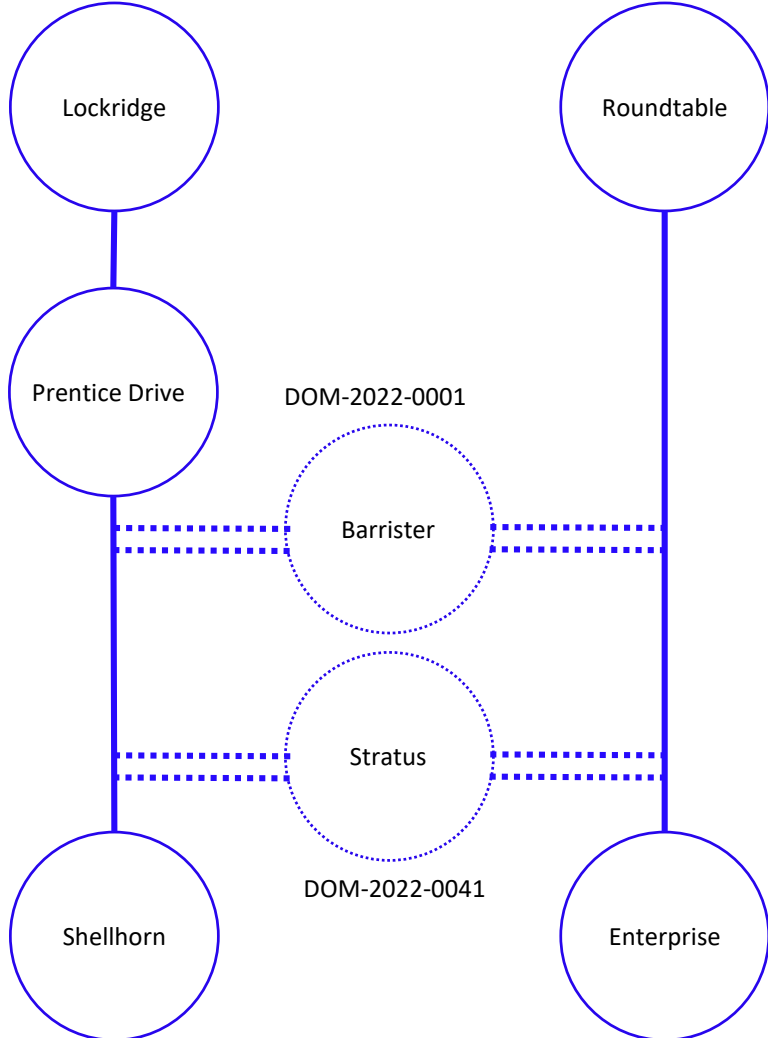

# Dominion Transmission Zone M-3 Process

## Line #77 End of Life Rebuild

**Need Number:** DOM-2022-0016

**Process Stage:**

Submission of Supplemental Project for Inclusion in the Local Plan – 02/21/2024

**Previously Presented:**

Need – 07/21/2022

Solution – 08/18/2022

**Project Driver:**

Equipment Material Condition, Performance and Risk

**Specific Assumption Reference:**

See details on Equipment Material Condition, Performance and Risk in Dominion’s Planning Assumptions presented in December 2021.

**Problem Statement:**

Dominion Energy has identified a need to rebuild approximately 1.8 miles of 115kV line #77 (Carolina – Roanoke Rapids Hydro) based on the company’s End of Life criteria.

- Line #77 was constructed on 2 pole and 3 pole wood H-frame structures in 1931 from Carolina to Roanoke Rapids Hydro. This line has ACSR and CU conductor and 7/16” steel static.
- Industry guidelines indicate equipment life for wood structures is 35-55 years, conductor and connectors are 40-60 years, and porcelain insulators are 50 years.
- Line #77 is the sole transmission feed for Roanoke Rapids Hydro Generation.

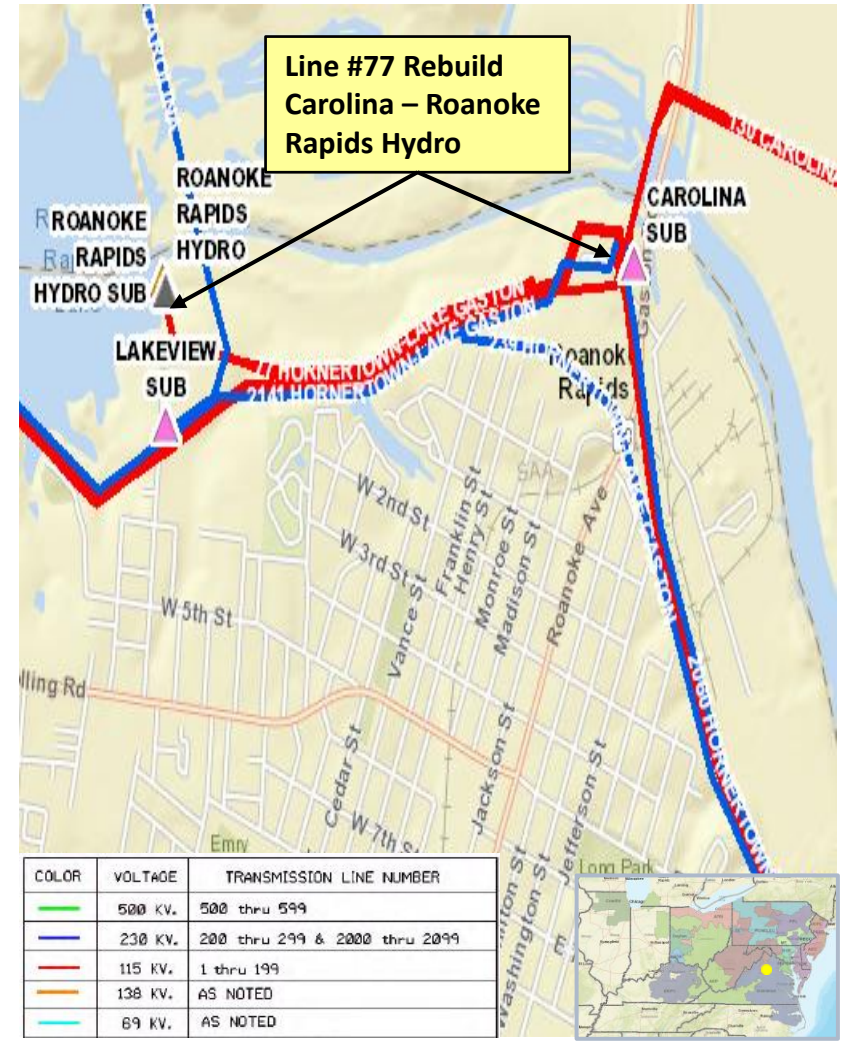

# Dominion Transmission Zone M-3 Process Line #77 End of Life Rebuild

**Need Number:** DOM-2022-0016

**Process Stage:**

Submission of Supplemental Project for Inclusion in the Local Plan – 02/21/2024

**Selected Solution:**

Rebuild approximately 1.8 miles single circuit of line #77 from Carolina to Roanoke Rapids Hydro to current 115 kV standards, and with a conductor minimum summer normal rating of 262 MVA. The terminal ends should be upgraded as needed.

**Estimated Cost:** \$7.4 M

**Projected In-Service:** 11/28/2025

**Supplemental Project ID:** s3038

**Project Status:** Conceptual

**Model:** 2025 RTEP

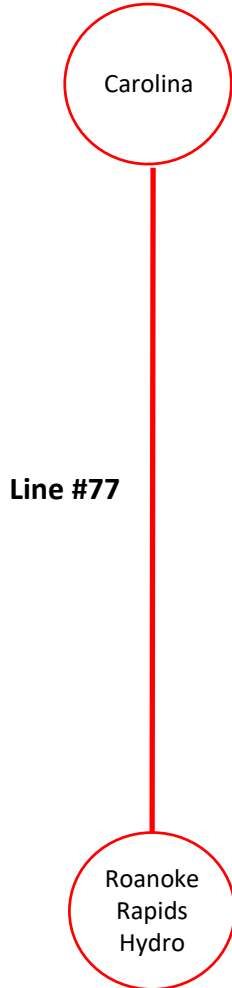

# Dominion Transmission Zone M-3 Process Allegheny 138kV Delivery Point - DEV

**Need Number:** DOM-2022-0022

**Process Stage:**

Submission of Supplemental Project for Inclusion in the Local Plan – 02/21/2024

**Previously Presented:**

Need – 06/13/2022

Solution – 09/15/2022

**Project Driver:**

Customer Service

**Specific Assumption Reference:**

Customer load request will be evaluated per Dominion’s Facility Interconnection Requirements Document and Dominion’s Transmission Planning Criteria.

**Problem Statement:**

DEV distribution has submitted a DP Request for a new 138kV DP (Allegheny) to serve increasing load in Allegheny County. The total projected load will be approximately 21 MW by 2033. The requested in-service date is 12/31/2023.

**Projected 2028 Load**

**Summer:** 17.4 MW

**Winter:** 19.3 MW

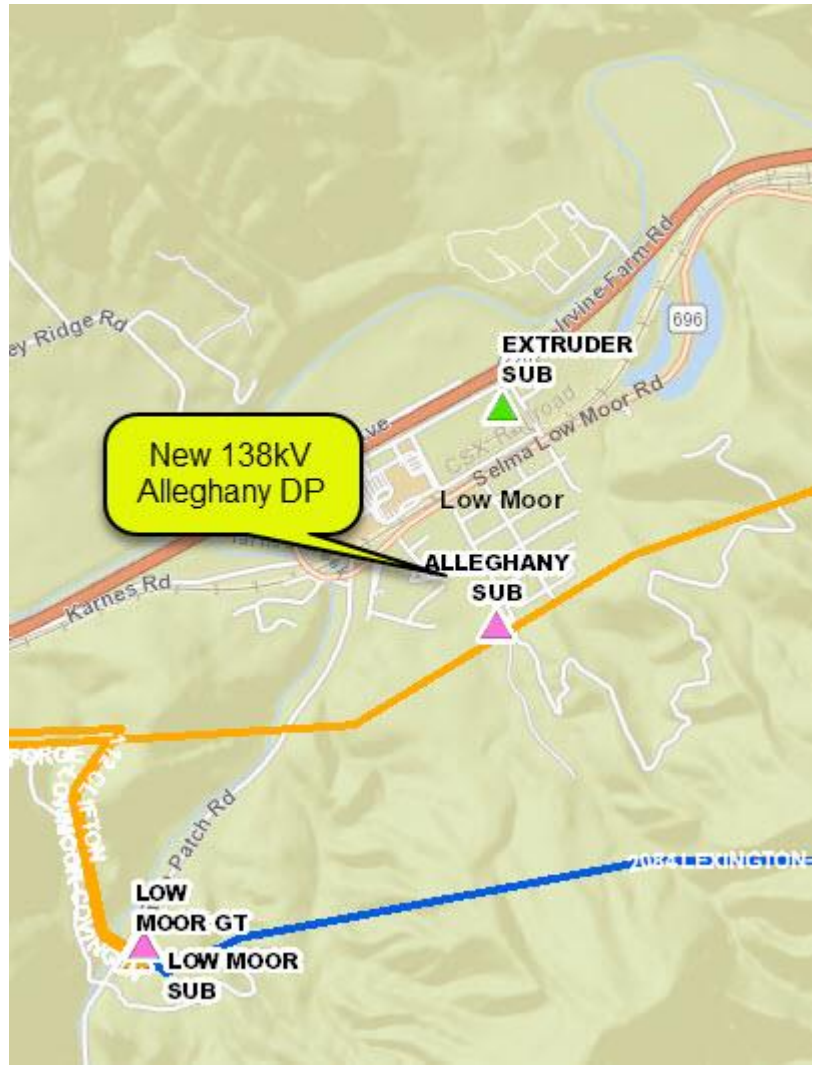

# Dominion Transmission Zone M-3 Process Allegheny 138kV Delivery Point - DEV

**Need Number:** DOM-2022-0022

**Process Stage:**

Submission of Supplemental Project for Inclusion in the Local Plan – 02/21/2024

**Selected Solution:**

Create a tee-tap on 138kV Line #133 Clifton Forge – Low Moor between structures 22 and 23 to source the customer substation located approximately 100’ away from the line. Install switch structures and switches on both sides of the tap point and an H-frame backbone structure inside Allegheny Substation, along with a wave trap, MOAB switch, circuit switcher and other ancillary work as needed.

**Estimated Cost:** \$5.0 M (Total)  
**Transmission Cost:** \$3.6 M  
**Substation Cost:** \$1.4 M

**Projected In-Service:** 12/20/2023

**Supplemental Project ID:** s3045

**Project Status:** Complete

**Model:** 2025 RTEP

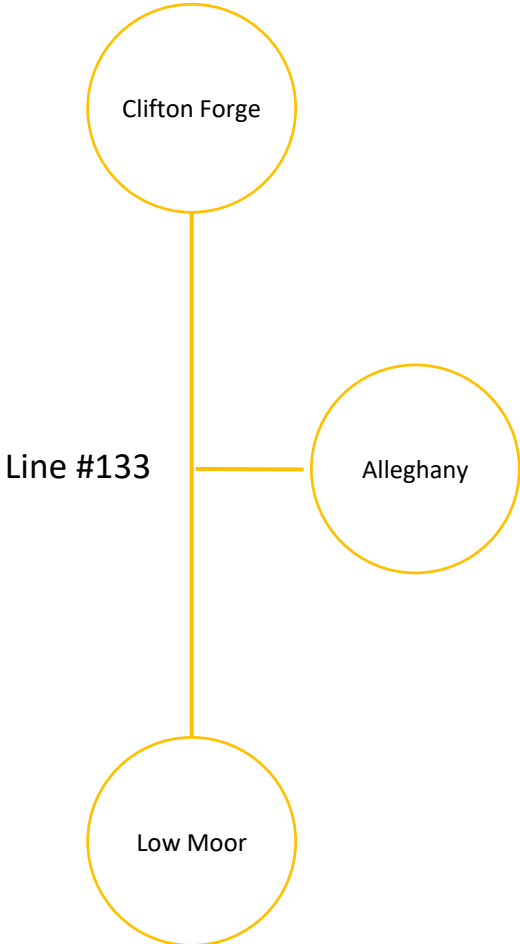

# Dominion Transmission Zone M-3 Process

## Jeffress 230kV Delivery - MEC

**Need Number:** DOM-2022-0032

**Process Stage:**

Submission of Supplemental Project for Inclusion in the Local Plan – 02/21/2024

**Previously Presented:**

Need – 06/07/2022

Solution – 04/11/2023

**Project Driver:**

Customer Service

**Specific Assumption Reference:**

Customer load request will be evaluated per Dominion’s Facility Interconnection Requirements Document and Dominion’s Transmission Planning Criteria.

**Problem Statement:**

ODEC on behalf of Mecklenburg Electric Coop (MEC) has submitted a delivery point request (Lakeside DP) for a new delivery point to serve a data center customer in Clarksville, VA. The total load is in excess of 100 MW. The customer requests service by Jan 1, 2025.

**Projected 2028 Load**

**Summer:** 103.0 MW

**Winter:** 103.0 MW

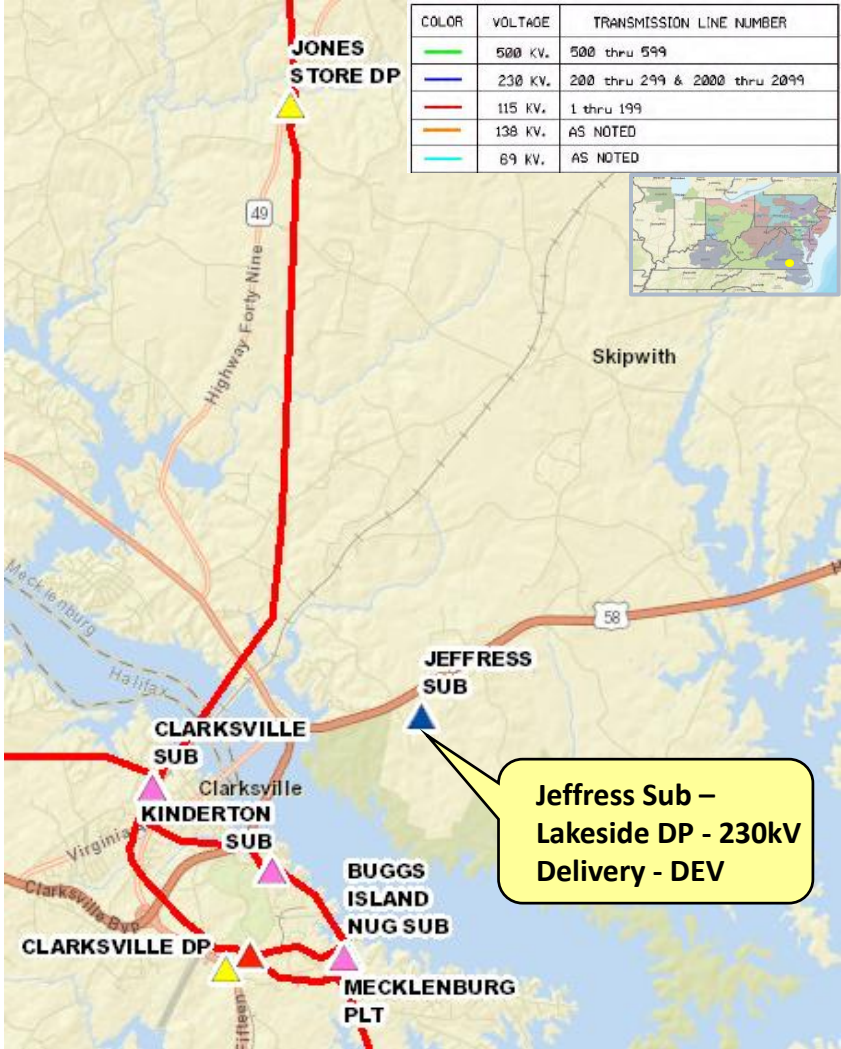

# Dominion Transmission Zone M-3 Process Jeffress 230kV Delivery - MEC

**Need Number:** DOM-2022-0032

**Process Stage:**  
Submission of Supplemental Project for Inclusion in the Local Plan – 02/21/2024

**Selected Solution:**  
The project will need to be built in 2 stages due to the timeframe associated with obtaining a CPCN and extend 230kV into the area. The 115kV Station will help meet the initial load target date.  
**Stage 1:** Interconnect the new substation by cutting and extending Line #36 (Chase City– Buggs Island) to the proposed Jeffress 115kV Substation. The substation and line equipment used to interconnect Jeffress 115 kV with the transmission system will be same as 230kV substation. The projected in-service date for Stage 1 is January 1, 2025.

**Stage 2:** Construct two 230kV single circuits from Finneywood 500/230kV sub to the proposed Jeffress 230kV Substation. Once conversion from 115kV to 230kV substation is complete, remove Jeffress 115kV tap and reconnect Line #36 Chase City– Buggs Island. The projected in-service date for Stage 2 is July 1, 2026.

**Estimated Cost:** \$120.0 M (Total)  
Transmission: \$90.0 M  
115kV Substation: \$15.0 M  
230kV Substation: \$15.0 M

**Projected In-Service:** 07/01/2026 (Stage 2)

**Supplemental Project ID:** s3061

**Project Status:** Engineering

**Model:** 2027 RTEP

**Stage 1: Jeffress 115kV Sub**

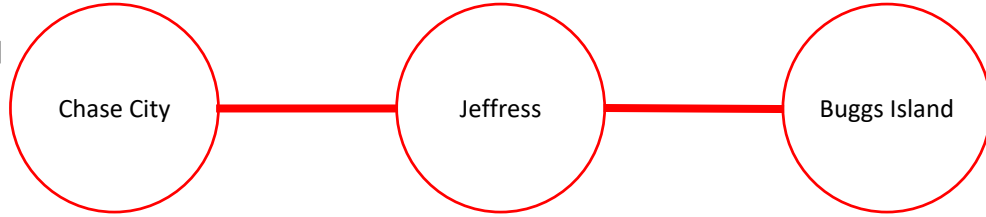

**Stage 2: Jeffress 230kV Sub**

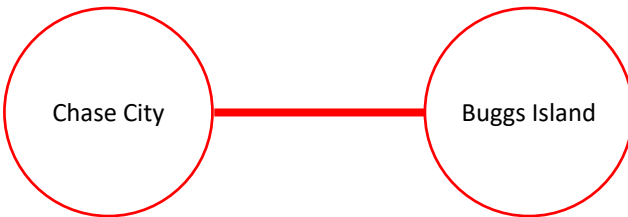
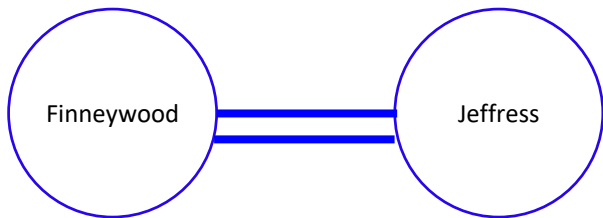
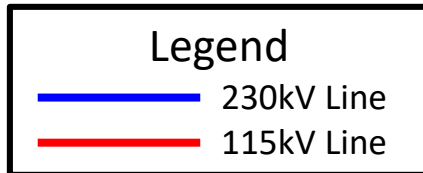

# Dominion Transmission Zone M-3 Process Sycolin Creek 230kV Delivery - DEV

**Need Number:** DOM-2022-0042

**Process Stage:**

Submission of Supplemental Project for Inclusion in the Local Plan – 02/21/2024

**Previously Presented:**

Need – 06/07/2022

Solution – 06/06/2023

**Project Driver:**

Customer Service

**Specific Assumption Reference:**

Customer load request will be evaluated per Dominion’s Facility Interconnection Requirements Document and Dominion’s Transmission Planning Criteria.

**Problem Statement:**

DEV has submitted a DP Request for a new substation (Sycolin Creek) in Loudoun County with a total load in excess of 100MW. Requested in-service date is 06/15/2026.

**Projected 2028 Load**

**Summer:** 136.0 MW

**Winter:** 100.0 MW

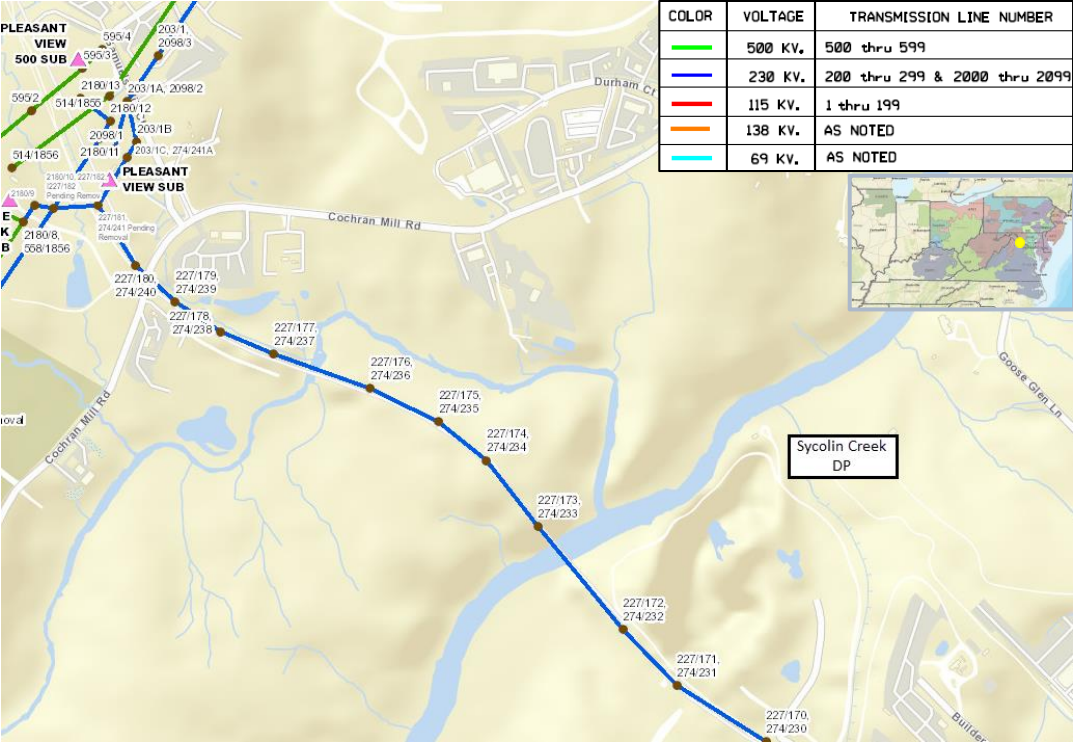



# Dominion Transmission Zone M-3 Process Sycolin Creek 230kV Delivery - DEV

**Need Number:** DOM-2022-0042

**Process Stage:**

Submission of Supplemental Project for Inclusion in the Local Plan – 02/21/2024

**Selected Solution:**

Interconnect the new substation by constructing two 230kV lines approximately 1.0 mile from Twin Creeks Substation to proposed Sycolin Creek Substation. Lines to terminate in a 230kV six-breaker ring arrangement.

**Estimated Cost:** \$28.0 M

**Projected In-Service:** 06/15/2026

**Supplemental Project ID:** s3048

**Project Status:** Engineering

**Model:** 2027 RTEP

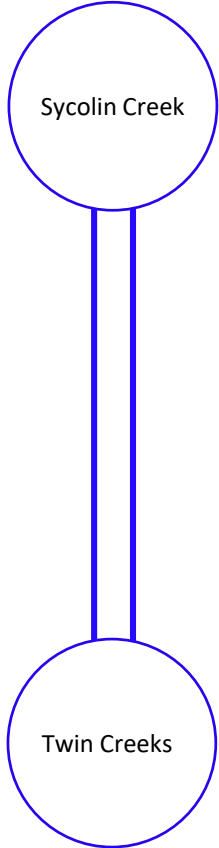

# Dominion Transmission Zone M-3 Process Twin Creeks 230kV Delivery - DEV

**Need Number:** DOM-2022-0043

**Process Stage:**

Submission of Supplemental Project for Inclusion in the Local Plan – 02/21/2024

**Previously Presented:**

Need – 06/07/2022

Solution – 06/06/2023

**Project Driver:**

Customer Service

**Specific Assumption Reference:**

Customer load request will be evaluated per Dominion’s Facility Interconnection Requirements Document and Dominion’s Transmission Planning Criteria.

**Problem Statement:**

DEV has submitted a DP Request for a new substation (Twin Creeks) in Loudoun County with a total load in excess of 100MW. Requested in-service date is 12/31/2024.

**Projected 2028 Load**

**Summer:** 209.2 MW

**Winter:** 183.0 MW

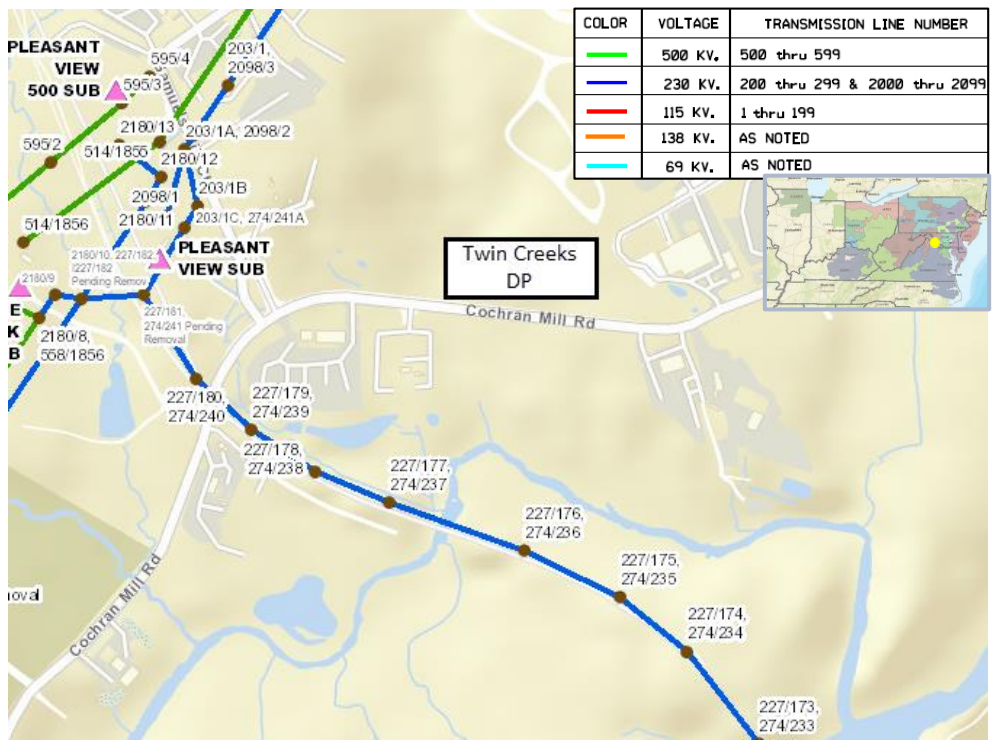

# Dominion Transmission Zone M-3 Process Twin Creeks 230kV Delivery - DEV

**Need Number:** DOM-2022-0043

**Process Stage:**

Submission of Supplemental Project for Inclusion in the Local Plan – 02/21/2024

**Selected Solution:**

Interconnect the new substation by cutting and extending Line #203 (Pleasant View – Edwards Ferry) to the proposed Twin Creeks Substation. Lines to terminate in a 230kV six-breaker ring arrangement.

**Estimated Cost:** \$20.0 M

**Projected In-Service:** 12/31/2024

**Supplemental Project ID:** s3049

**Project Status:** Engineering

**Model:** 2027 RTEP

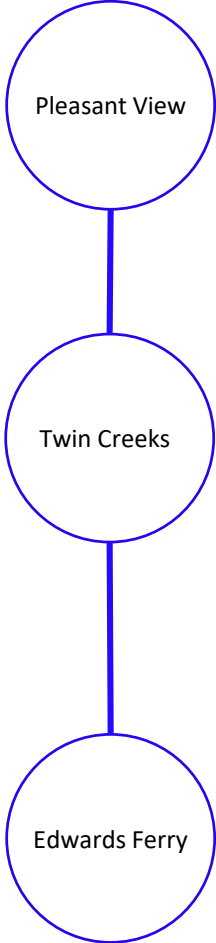

# Dominion Transmission Zone M-3 Process Do No Harm (DNH) Analysis

**Need Number:** DOM-2022-0046-DNH & DOM-2022-0047-DNH

**Process Stage:**  
Submission of Supplemental Project for Inclusion in the Local Plan – 02/21/2024

**Presentation Date:**  
DNH – 02/07/2023

**Supplemental Project Driver:**  
Do No Harm Analysis

**Specific Assumption Reference:**  
Customer load request will be evaluated per Dominion’s Facility Interconnection Requirements Document and Dominion’s Transmission Planning Criteria.

**Problem Statement:**  
PJM has identified N-1-1 thermal violations on the following separate facilities in the 2022 Do-No-Harm analysis:

- Line #2101 (Nokesville to Bristers Segment)
  - Contingency Scenario: DVP\_P1-2: LN 569 and DVP\_P1-2: LN 539
- Bristers 500-230 kV TX#1
  - Contingency Scenario: DVP\_P1-3: 8BRISTER-TX#1 and DVP\_P1-2: LN 539
- Bristers 500-230 kV TX#2
  - Contingency Scenario: DVP\_P1-3: 8BRISTER-TX#2 and DVP\_P1-2: LN 539

The violations are caused by previously presented Supplemental Projects DOM-2022-0046 and DOM-2022-0047 in the Dominion Zone.

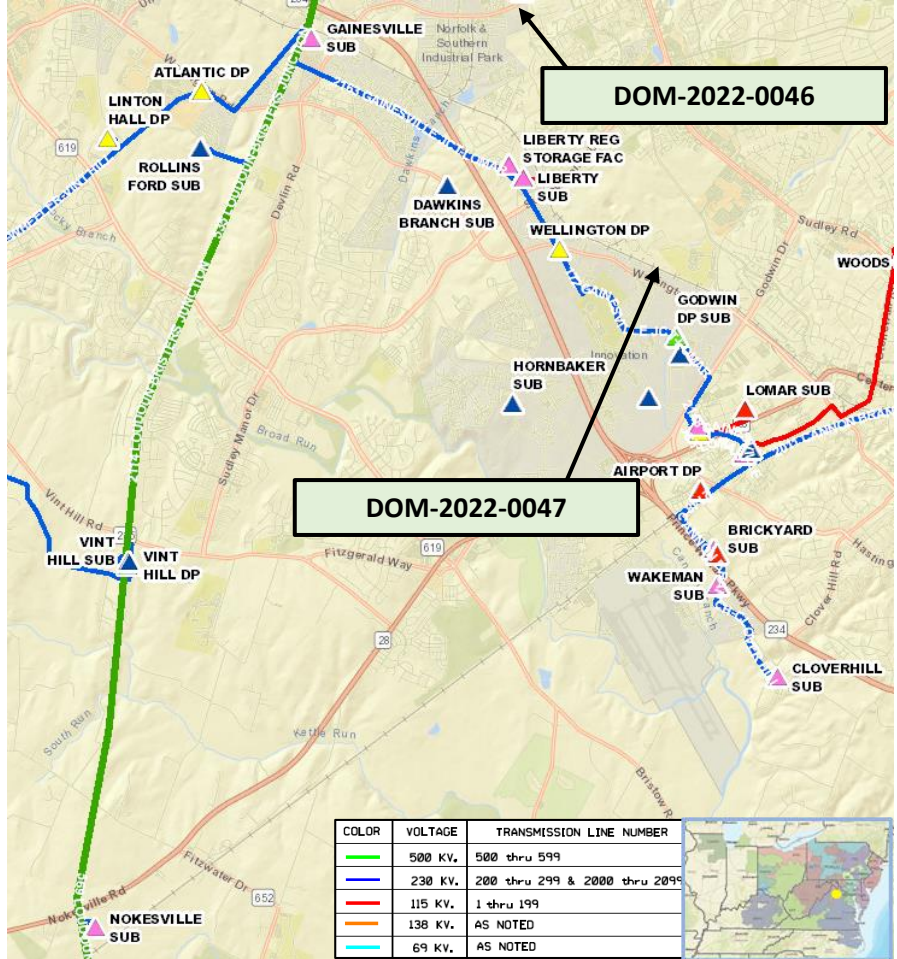

# Dominion Transmission Zone M-3 Process Do No Harm (DNH) Analysis

**Need Number:** DOM-2022-0046-DNH & DOM-2022-0047-DNH

**Process Stage:**

Submission of Supplemental Project for Inclusion in the Local Plan – 02/21/2024

**Selected Solution (Part 1 of 2):**

To address: 230 kV Line Violation

- Reconductor approximately 9.2 miles of Line #2101 (Nokesville to Bristers) using a higher capacity conductor as well as terminal equipment upgrades to achieve a minimum normal summer conductor rating of 1573 MVA.

**Estimated Cost:** \$23.0M

**Projected In-Service:** 12/31/2027

**Supplemental Project ID:** s3047.1

**Project Status:** Conceptual

**Model:** 2027 RTEP

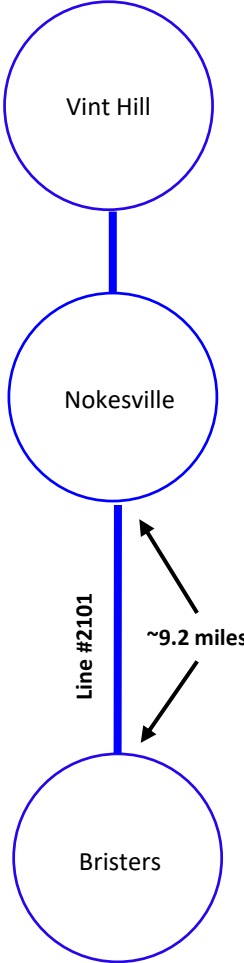

# Dominion Transmission Zone M-3 Process Do No Harm (DNH) Analysis

**Need Number:** DOM-2022-0046-DNH & DOM-2022-0047-DNH

**Process Stage:**

Submission of Supplemental Project for Inclusion in the Local Plan – 02/21/2024

**Selected Solution (Part 2 of 2):**

To address: Bristers 500-230 kV TX #1 & 2 Violation

- Install (2) 1400 MVA 500-230 kV transformer and associated 500 kV and 230 kV equipment (breakers, switches, leads) at Vint Hill Substation to supply the area with a 500 kV source
- Cut and loop 500 kV line #535 (Loudoun – Meadowbrook) and #569 (Loudoun - Morrisville) as the 500 kV sources into the proposed 500 kV ring bus
- Vint Hill Substation will be expanded to the north of the existing site to accommodate the 500 kV ring required for the addition of the new transformers
- Existing terminations for 230 kV line #2174 (Wheeler – Vint Hill), line #2101 (Bristers – Vint Hill), and line #2163 (Liberty – Vint Hill) will be rearranged to terminate into the expanded Vint Hill Substation
- 230 kV line #2114 (Remington CT – Rollins Ford) will also be cut and looped into the expanded Vint Hill Substation due to spatial constraints along the existing right-of-way

**Estimated Cost:** \$115.0M (Total)  
**Transmission Line Cost:** \$5.0M  
**Substation Cost:** \$110.0M

**Projected In-Service:** 12/31/2027

**Supplemental Project ID:** s3047.2

**Project Status:** Conceptual

**Model:** 2027 RTEP

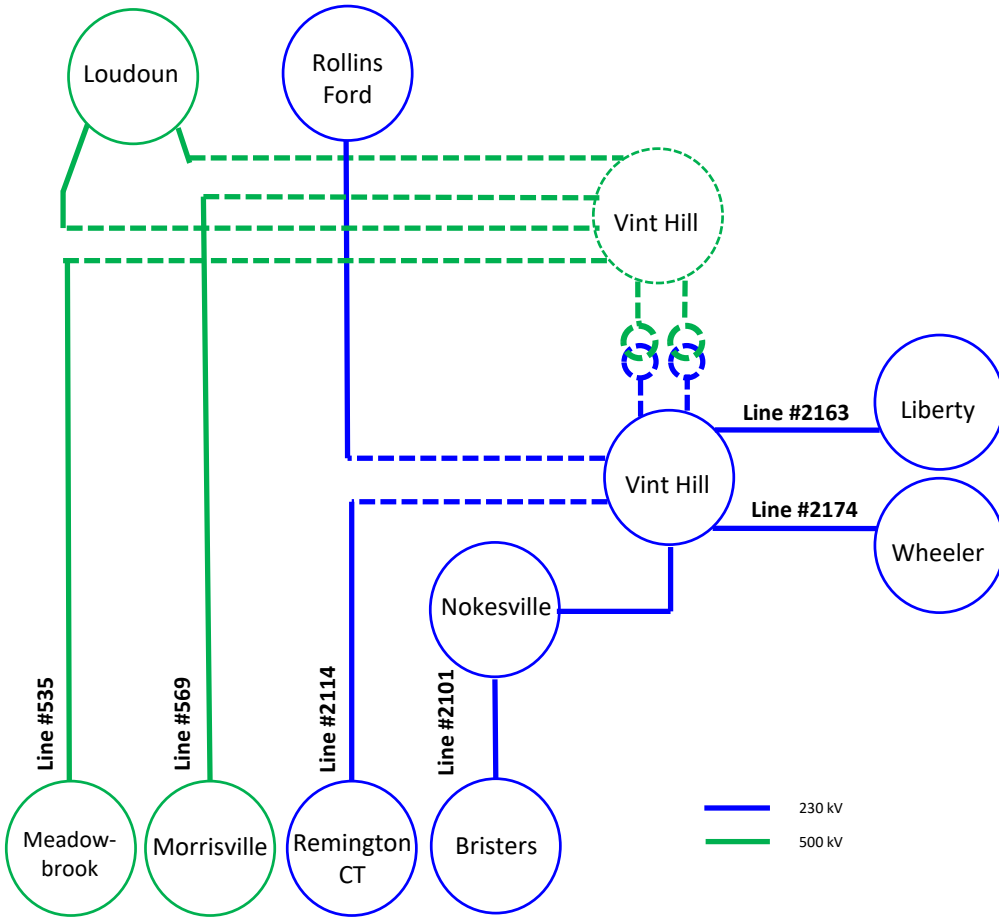

# Dominion Transmission Zone M-3 Process Cemetery Rd 115kV Delivery - DEV

**Need Number:** DOM-2022-0048

**Process Stage:**

Submission of Supplemental Project for Inclusion in the Local Plan – 02/21/2024

**Previously Presented:**

Need – 07/21/2022

Solution – 08/18/2022

**Project Driver:**

Customer Service

**Specific Assumption Reference:**

Customer load request will be evaluated per Dominion’s Facility Interconnection Requirements Document and Dominion’s Transmission Planning Criteria.

**Problem Statement:**

DEV Distribution has submitted a delivery point request for a new delivery point to serve a motor load customer in Chase City, VA. The total load is less than 100 MW. The customer requests service by October 15, 2024.

**Projected 2028 Load**

**Summer:** 49.2 MW

**Winter:** 49.2 MW

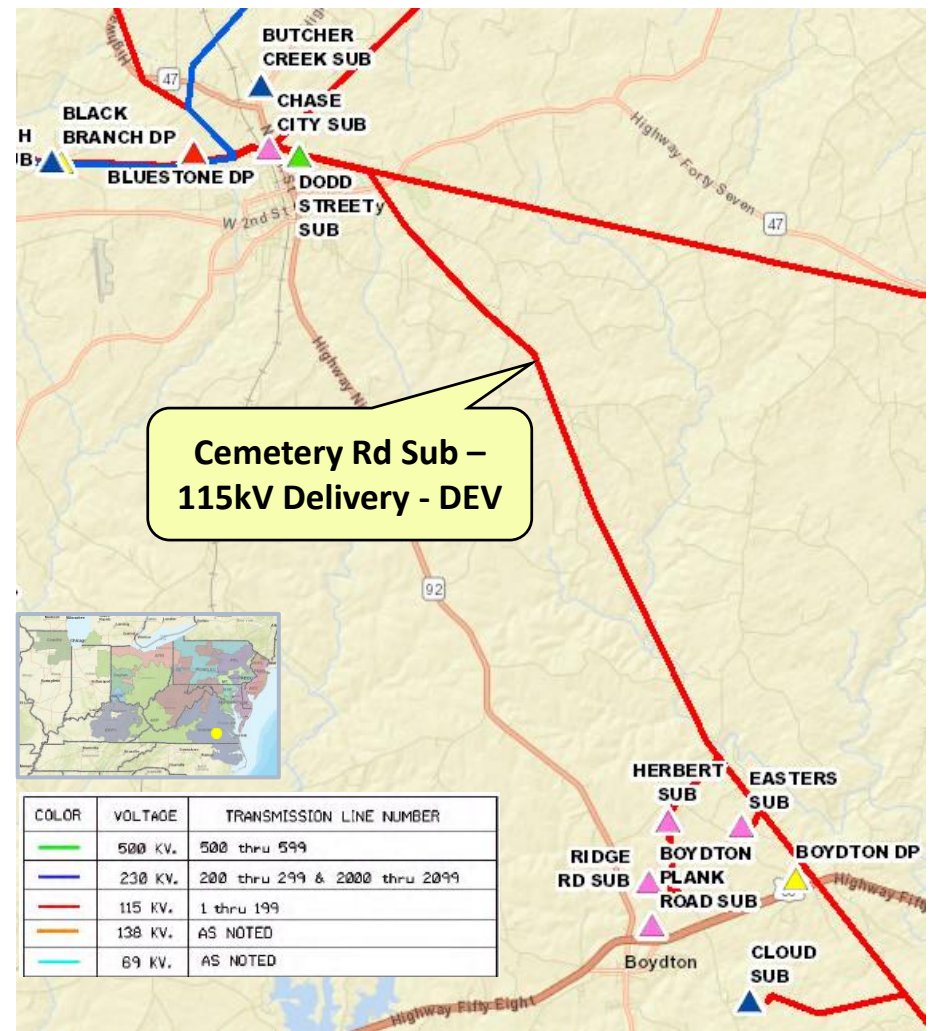

# Dominion Transmission Zone M-3 Process Cemetery Rd 115kV Delivery - DEV

**Need Number:** DOM-2022-0048

**Process Stage:**

Submission of Supplemental Project for Inclusion in the Local Plan – 02/21/2024

**Selected Solution:**

Tap Line #171 (Chase City – Herbert) near structure 171/51 and extend a single circuit 115kV tap to Cemetery Road sub.

<b>Estimated Cost:</b>	\$5.0 M (Total)
Transmission Line	\$4.0 M
115kV Substation	\$1.0 M

**Projected In-Service:** 10/15/2024

**Supplemental Project ID:** s3039

**Project Status:** Engineering

**Model:** 2025 RTEP

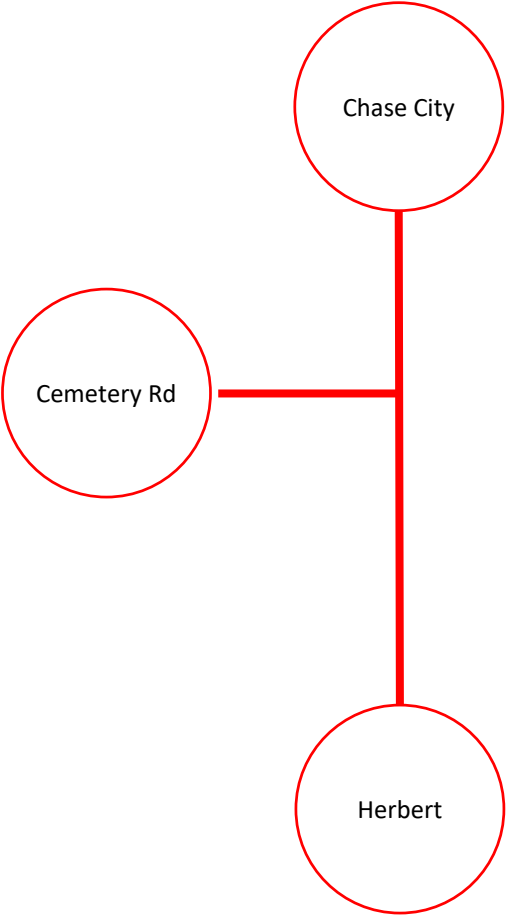



# Dominion Transmission Zone M-3 Process Gretna 69kV Delivery- Add 2<sup>nd</sup> TX - DEV

**Need Number:** DOM-2022-0050

**Process Stage:**

Submission of Supplemental Project for Inclusion in the Local Plan – 02/21/2024

**Previously Presented:**

Need – 08/18/2022

Solution – 09/15/2022

**Project Driver:**

Customer Service

**Specific Assumption Reference:**

Customer load request will be evaluated per Dominion’s Facility Interconnection Requirements Document and Dominion’s Transmission Planning Criteria.

**Problem Statement:**

DEV Distribution has submitted a DP Request to add a 2nd, 3 - 2.5/3.125 MVA distribution transformer at Gretna Substation in Pittsylvania County, Virginia. The new transformer is needed for voltage island mitigation. Requested in-service date is 12/15/2024.

**Projected 2028 Load**

**Summer:** 8.5 MW

**Winter:** 7.5 MW

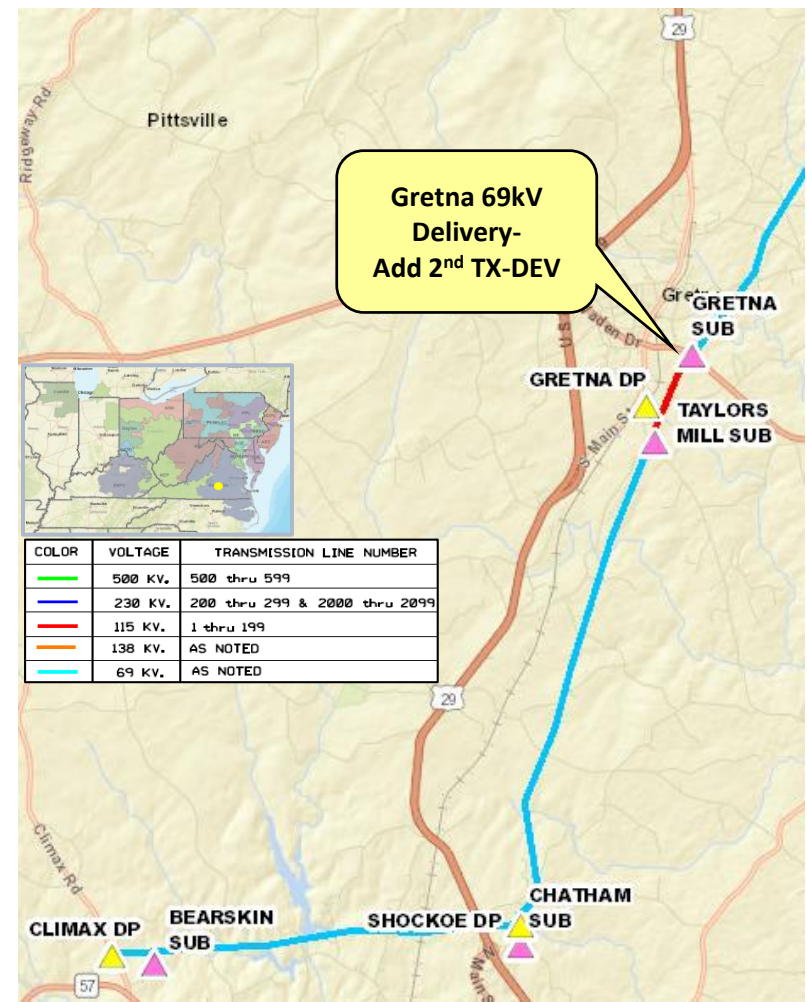

# Dominion Transmission Zone M-3 Process Gretna 69kV Delivery- Add 2<sup>nd</sup> TX - DEV

**Need Number:** DOM-2022-0050

**Process Stage:**

Submission of Supplemental Project for Inclusion in the Local Plan – 02/21/2024

**Selected Solution:**

Install a 69kV circuit switcher, high side switch and associated equipment (bus, switches, relaying, etc.) to feed the new transformer at Gretna.

**Estimated Cost:** \$0.5 M

**Projected In-Service:** 12/15/2024

**Supplemental Project ID:** s3046

**Project Status:** Engineering

**Model:** 2025 RTEP



# Dominion Transmission Zone M-3 Process Replace Clover Substation Breakers and Switches

**Need Number:** DOM-2022-0051

**Process Stage:**

Submission of Supplemental Project for Inclusion in the Local Plan – 02/21/2024

**Previously Presented:**

Need – 09/06/2022

Solution – 11/01/2022

**Project Driver:**

Equipment Material Condition, Performance and Risk

**Specific Assumption Reference:**

See details on Equipment Material Condition, Performance and Risk in Dominion’s Planning Assumptions presented in December 2021.

**Problem Statement:**

Dominion Energy has identified a need to replace five 230kV breakers (L912, 206812, SX1212, SX12T235 & 23512) and six disconnect switches (SX1214, SX1215, SX1218, 23518, 23514, & 23515) at Clover Substation. These breakers and switches were manufactured in 1993 and are at end of life. Additionally, there has been an increase in maintenance issues and difficulties in obtaining spare parts.

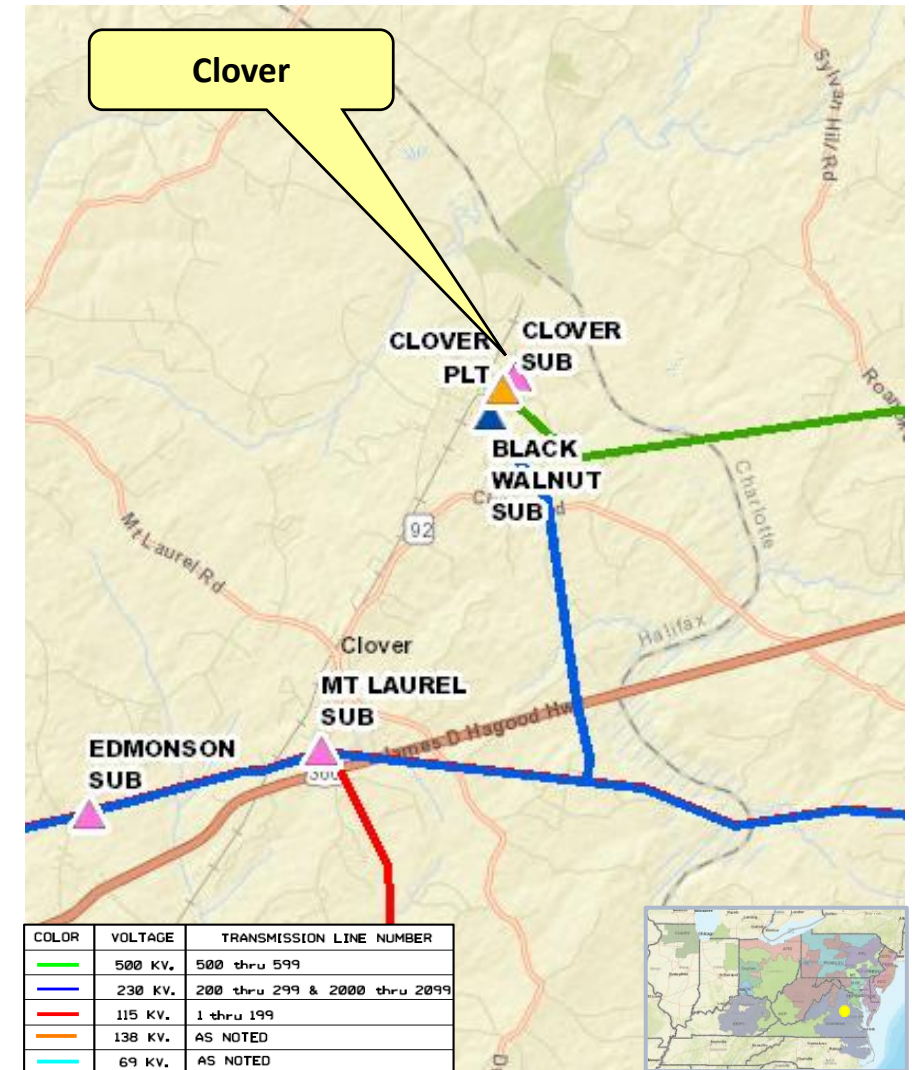

# Dominion Transmission Zone M-3 Process

## Replace Clover Substation Breakers and Switches

**Need Number:** DOM-2022-0051

**Process Stage:**

Submission of Supplemental Project for Inclusion in the Local Plan – 02/21/2024

**Selected Solution:**

Replace the following 230kV breakers and switches at Clover Substation -

- Two breakers (L912 and 206812) with 3000 amp 50kA breakers.
- Three breakers (SX1212, SX12T235 & 23512) with 4000 amp 63kA breakers.
- Six disconnect switches (SX1214, SX1215, SX1218, 23518, 23514, & 23515) with 4000 amp switches.

**Estimated Cost:** \$2.75 M

**Projected In-Service:** 07/13/2023

**Supplemental Project ID:** s3050

**Project Status:** Completed

**Model:** 2027 RTEP

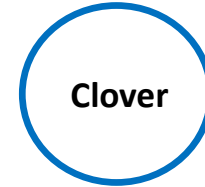

# Dominion Transmission Zone M-3 Process

## Replace North Anna Substation Breakers and Switches

**Need Number:** DOM-2022-0052

**Process Stage:**

Submission of Supplemental Project for Inclusion in the Local Plan – 02/21/2024

**Previously Presented:**

Need – 09/06/2022

Solution – 11/01/2022

**Project Driver:**

Equipment Material Condition, Performance and Risk

**Specific Assumption Reference:**

See details on Equipment Material Condition, Performance and Risk in Dominion’s Planning Assumptions presented in December 2021.

**Problem Statement:**

Dominion Energy has identified a need to replace 230kV equipment at North Anna substation:

- Breaker 25502 at end of life, manufactured in 1993
- Center breaker switches H304, H305, 25504 and 25505 at end of life about 20 years old
- Line #255 wave trap at end of life 21 years old
- Transformer #3 circuit high side switcher H302 due to fault interruption requirements

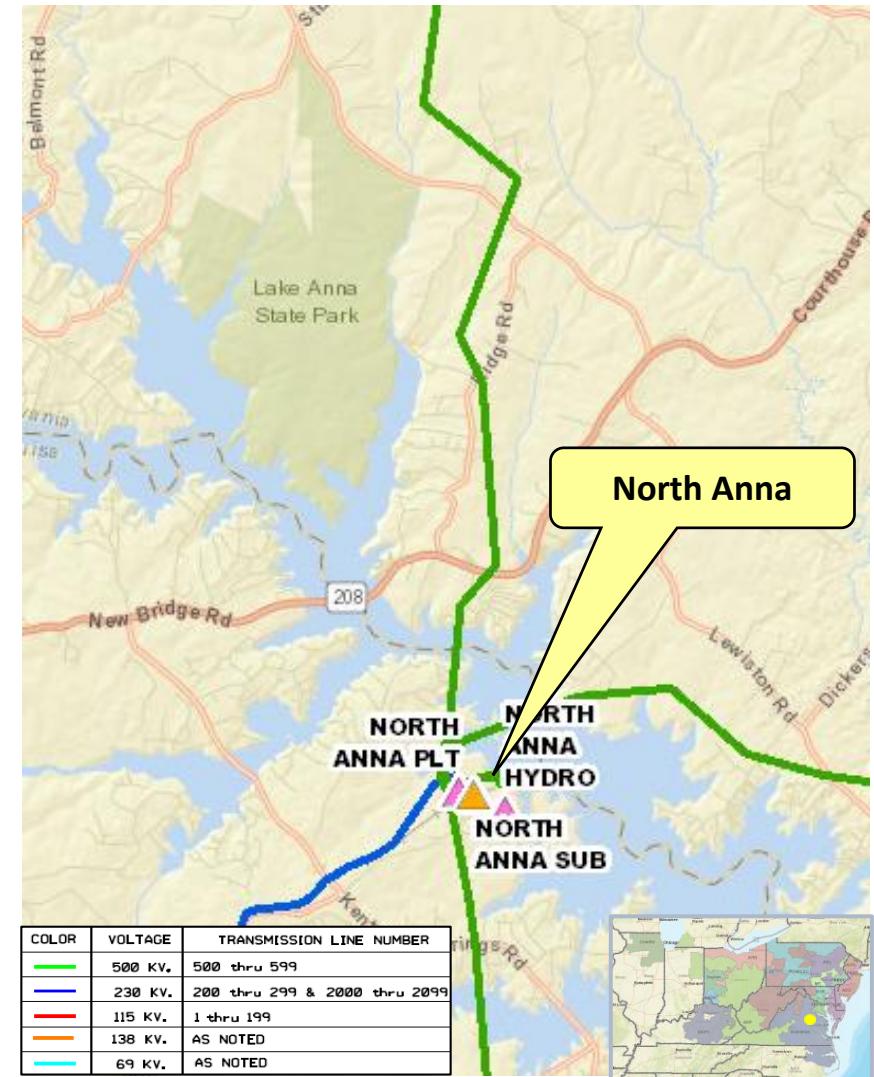

# Dominion Transmission Zone M-3 Process

## Replace North Anna Substation Breakers and Switches

**Need Number:** DOM-2022-0052

**Process Stage:**

Submission of Supplemental Project for Inclusion in the Local Plan – 02/21/2024

**Selected Solution:**

Replace the following 230kV equipment at North Anna Substation -

- Breaker 25502 with a 3000 amp 63kA breaker.
- Center breaker switches H304, H305, 25504 and 25505 with 3000 amp switches
- Line #255 wave trap with a 3000 amp wave trap
- Transformer #3 circuit high side switcher H302 with a 1200 amp 40kAIC circuit switcher

**Estimated Cost:** \$2.36 M

**Projected In-Service:** 07/27/2023

**Supplemental Project ID:** s3058

**Project Status:** Completed

**Model:** 2027 RTEP

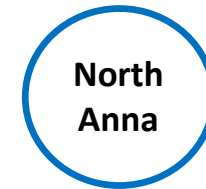

# Dominion Transmission Zone M-3 Process

## Replace Davis TX#2 - DEV

**Need Number:** DOM-2022-0053

**Process Stage:**

Submission of Supplemental Project for Inclusion in the Local Plan – 02/21/2024

**Previously Presented:**

Need – 09/06/2022

Solution – 11/01/2022

**Project Driver:**

Equipment Material Condition, Performance and Risk

**Specific Assumption Reference:**

See details on Equipment Material Condition, Performance and Risk in Dominion’s Planning Assumptions presented in December 2021.

**Problem Statement:**

Davis TX#2 is a 168 MVA, 230/69/13.2 kV transformer bank that was manufactured in 1990. This transformer bank has been identified for replacement based on the results of Dominion’s transformer health assessment (THA) process. Detailed drivers include:

- Age (>30 years old).
- Reduced BIL ratings (2 levels below standard).
- Tertiary winding design not meeting current MVA requirement for loading.
- Degraded porcelain type bushings.

Additionally, a protection scheme update at Davis requires the addition of multiple external bushing CT’s to the low-voltage and high-voltage bushings which will compromise strike distances on the bushings. The ability to add more internal CT’s was not considered when the transformer was ordered in 1989.

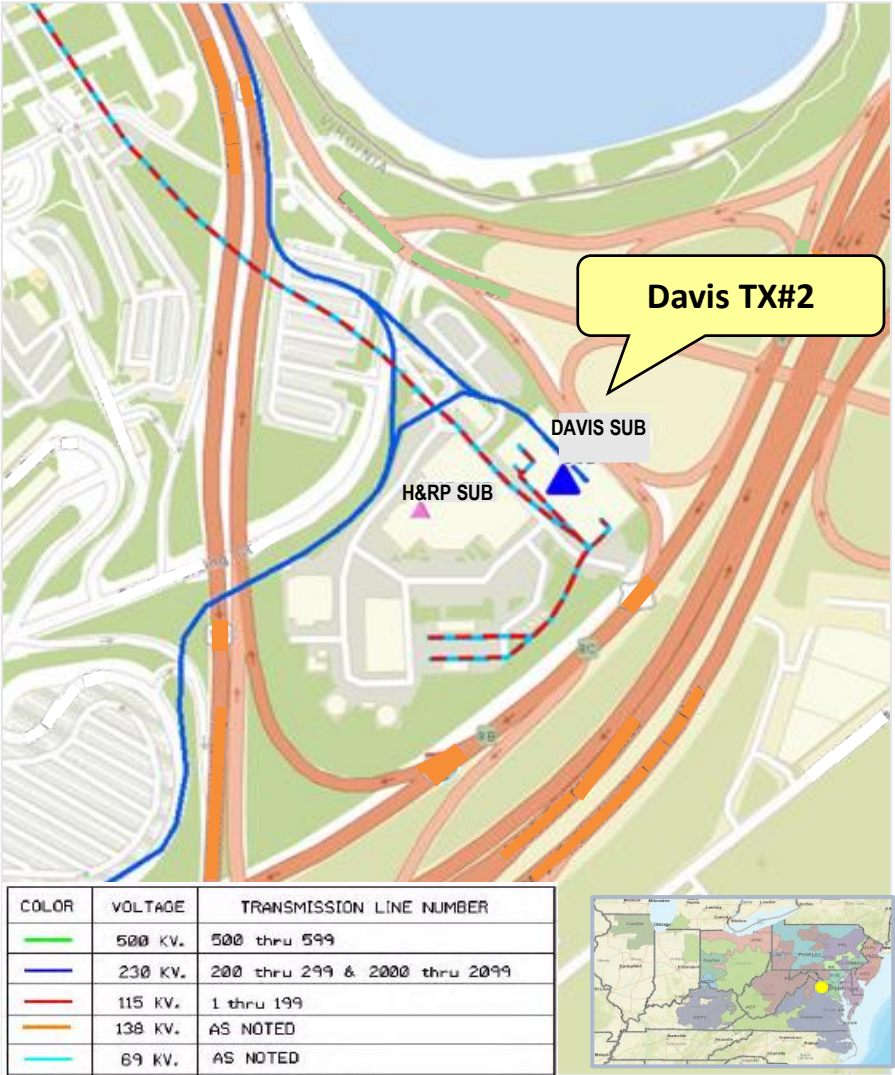

# Dominion Transmission Zone M-3 Process

## Replace Davis TX#2 - DEV

**Need Number:** DOM-2022-0053

**Process Stage:**

Submission of Supplemental Project for Inclusion in the Local Plan – 02/21/2024

**Selected Solution:**

Replace Davis TX#2 with a new three-phase, 230/69/13.2 kV, 168 MVA unit.  
Include other ancillary equipment (arresters, switches, relays, etc.) as needed.

**Estimated Cost:** \$4.5 M

**Projected In-Service:** 05/31/2024

**Supplemental Project ID:** s3059

**Project Status:** Construction

**Model:** 2027 RTEP

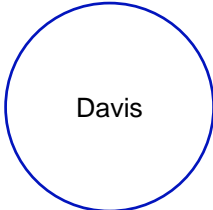



# Dominion Transmission Zone M-3 Process

## Lunar 230kV Delivery - DEV

**Need Number:** DOM-2022-0054

**Process Stage:**

Submission of Supplemental Project for Inclusion in the Local Plan – 02/21/2024

**Previously Presented:**

Need – 10/04/2022

Solution – 07/11/2023

**Project Driver:**

Customer Service

**Specific Assumption Reference:**

Customer load request will be evaluated per Dominion’s Facility Interconnection Requirements Document and Dominion’s Transmission Planning Criteria.

**Problem Statement:**

DEV has submitted a DP Request for a new substation (Lunar) in Loudoun County with a total load in excess of 100MW. Requested in-service date is 08/01/2026.

**Projected 2028 Load**

**Summer:** 188.0 MW

**Winter:** 140.0 MW

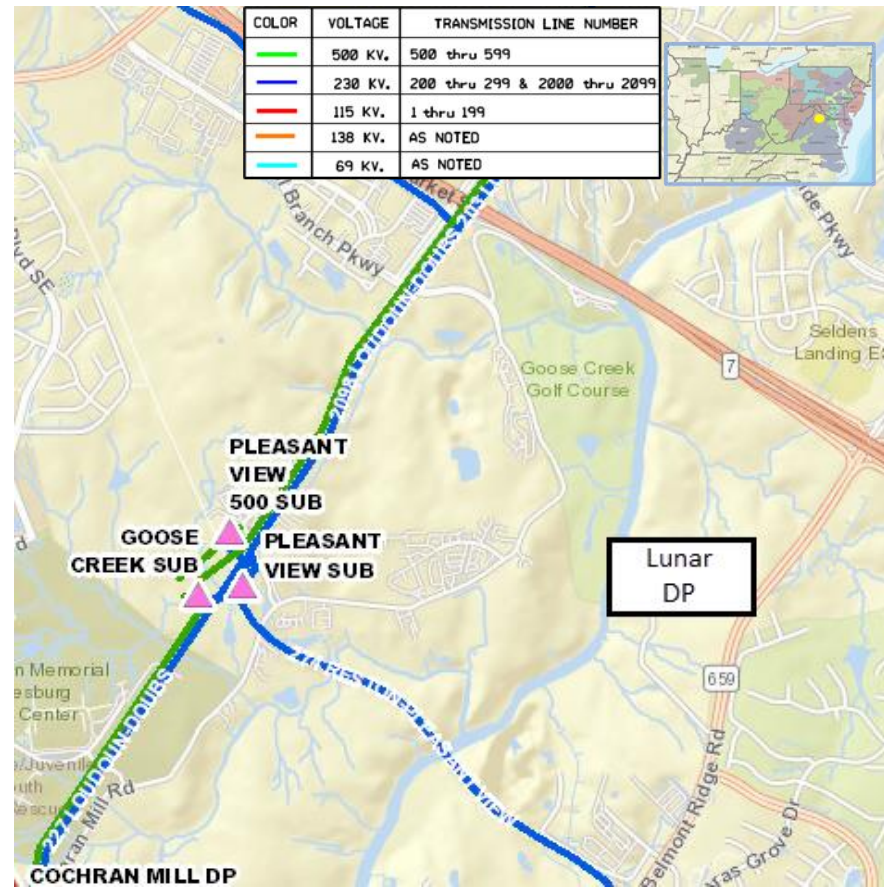

# Dominion Transmission Zone M-3 Process Lunar 230kV Delivery - DEV

**Need Number:** DOM-2022-0054

**Process Stage:**

Submission of Supplemental Project for Inclusion in the Local Plan – 02/21/2024

**Selected Solution:**

Interconnect the new substation by constructing two 230kV lines from Sycolin Creek Substation to proposed Lunar Substation. Lines to terminate in a 230kV six-breaker ring arrangement.

**Estimated Cost:** \$28.0 M

**Projected In-Service:** 08/01/2026

**Supplemental Project ID:** s3074

**Project Status:** Engineering

**Model:** 2027 RTEP

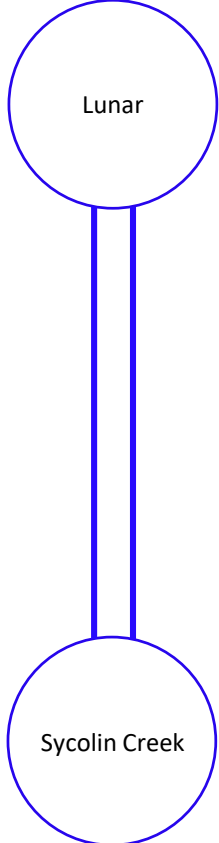

# Dominion Transmission Zone M-3 Process

## Apollo 230kV Delivery - DEV

**Need Number:** DOM-2022-0055

**Process Stage:**

Submission of Supplemental Project for Inclusion in the Local Plan – 02/21/2024

**Previously Presented:**

Need – 11/01/2022

Solution – 07/11/2023

**Project Driver:**

Customer Service

**Specific Assumption Reference:**

Customer load request will be evaluated per Dominion’s Facility Interconnection Requirements Document and Dominion’s Transmission Planning Criteria.

**Problem Statement:**

DEV has submitted a DP Request for a new substation (Apollo) in Loudoun County with a total load in excess of 100MW. Requested in-service date is 1/1/2027.

**Projected 2028 Load**

**Summer:** 111.0 MW

**Winter:** 69.0 MW

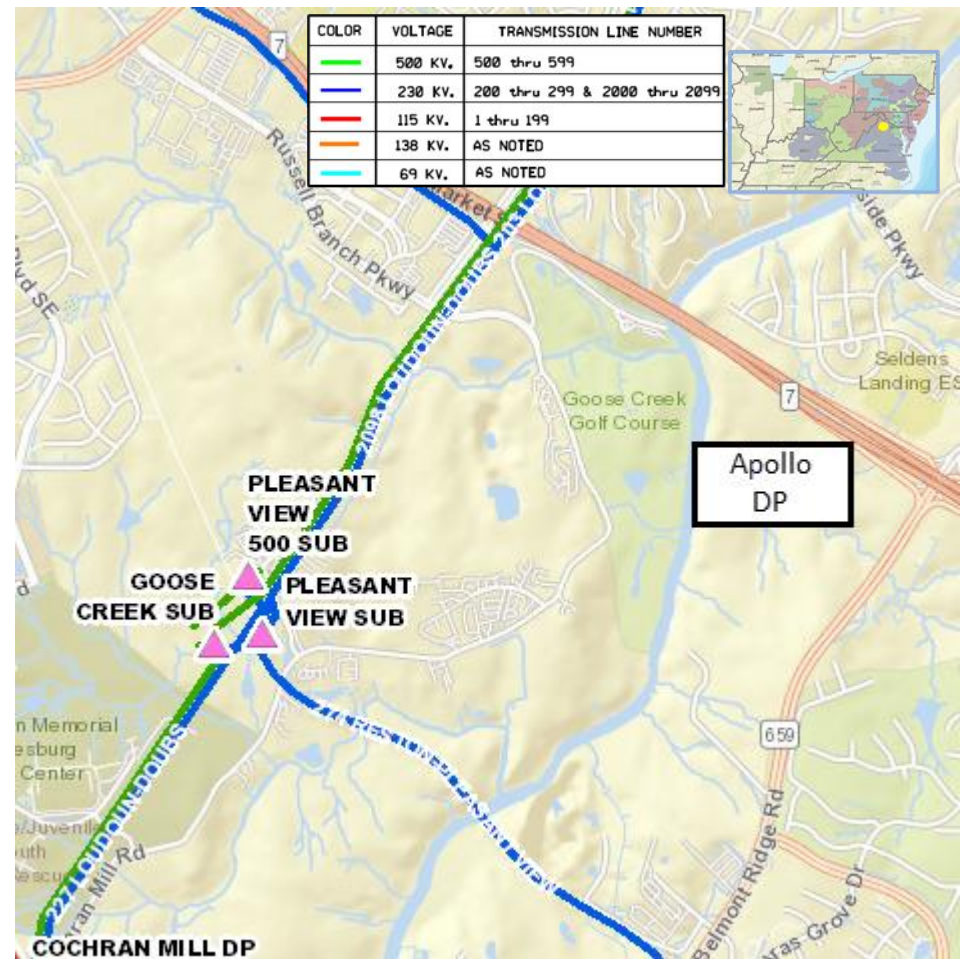

# Dominion Transmission Zone M-3 Process

## Apollo 230kV Delivery - DEV

**Need Number:** DOM-2022-0055

**Process Stage:**

Submission of Supplemental Project for Inclusion in the Local Plan – 02/21/2024

**Selected Solution:**

Interconnect the new substation by constructing two 230kV lines from Lunar Substation to proposed Apollo Substation. Lines to terminate in a 230kV six-breaker ring arrangement.

**Estimated Cost:** \$28.0 M

**Projected In-Service:** 01/01/2027

**Supplemental Project ID:** s3075

**Project Status:** Engineering

**Model:** 2027 RTEP

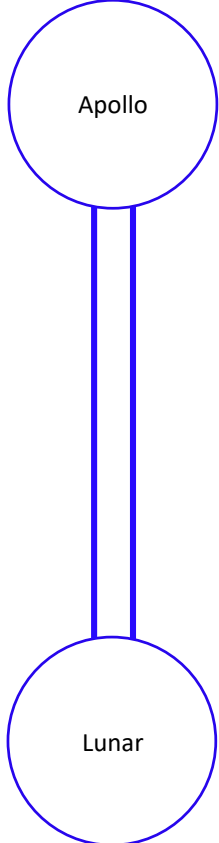

# Dominion Transmission Zone M-3 Process Pluto 230kV Delivery - DEV

**Need Number:** DOM-2022-0056

**Process Stage:**

Submission of Supplemental Project for Inclusion in the Local Plan – 02/21/2024

**Previously Presented:**

Need – 10/04/2022

Solution – 08/08/2023

**Project Driver:**

Customer Service

**Specific Assumption Reference:**

Customer load request will be evaluated per Dominion’s Facility Interconnection Requirements Document and Dominion’s Transmission Planning Criteria.

**Problem Statement:**

DEV has submitted a DP Request for a new substation (Pluto) in Loudoun County with a total load in excess of 100MW. Requested in-service date is 06/1/2026.

**Projected 2028 Load**

**Summer:** 110.0 MW

**Winter:** 72.0 MW

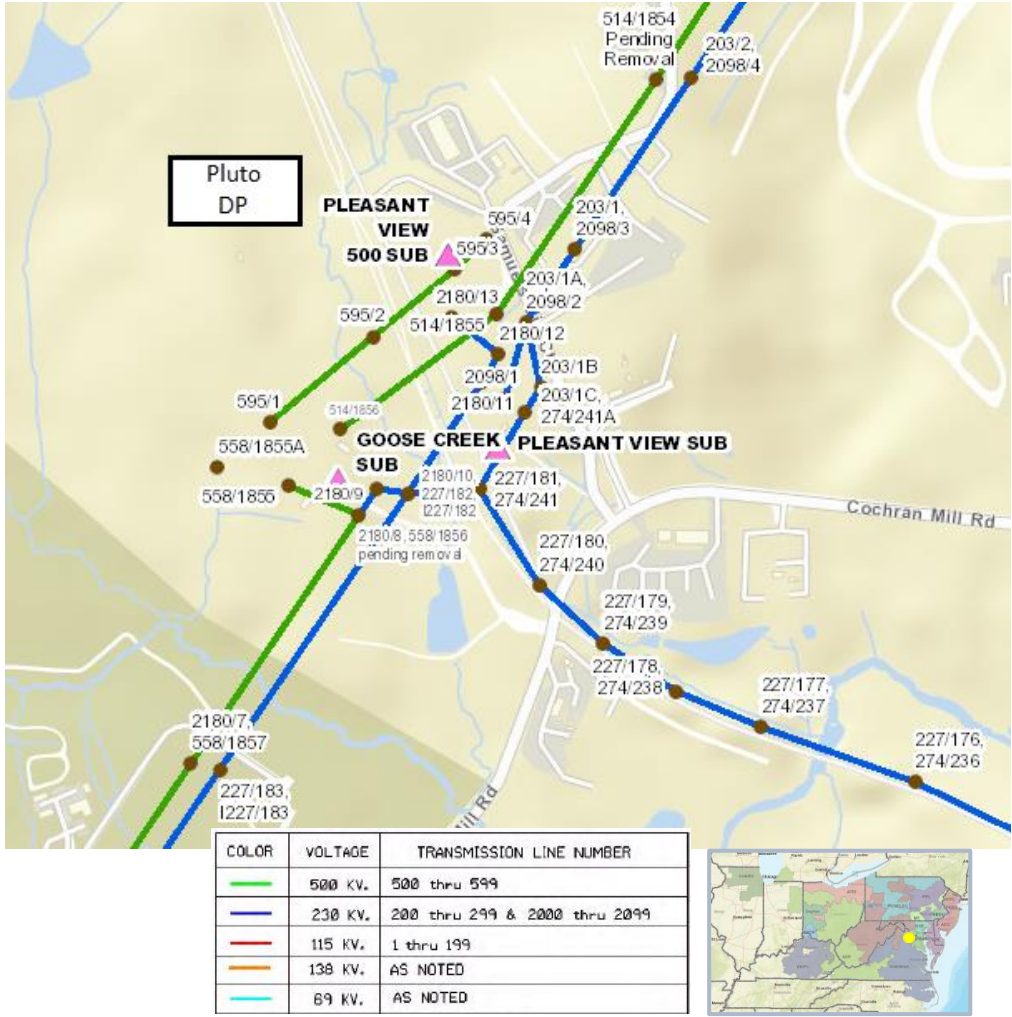

# Dominion Transmission Zone M-3 Process Pluto 230kV Delivery - DEV

**Need Number:** DOM-2022-0056

**Process Stage:**

Submission of Supplemental Project for Inclusion in the Local Plan – 02/21/2024

**Selected Solution:**

Interconnect the new substation by cutting and extending Line #2180 (Pleasant View – Belmont) to the proposed Pluto Substation. Lines to terminate in a 230kV four-breaker ring arrangement.

**Estimated Cost:** \$20.0 M

**Projected In-Service:** 06/01/2026

**Supplemental Project ID:** s3080

**Project Status:** Engineering

**Model:** 2027 RTEP

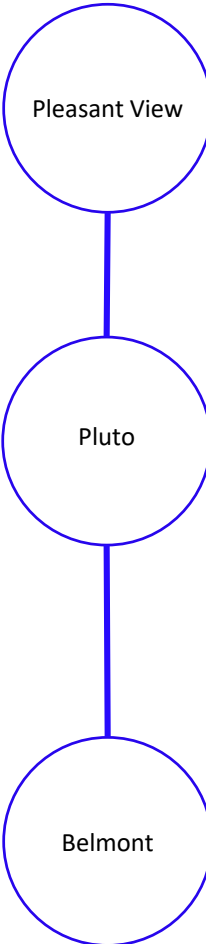

# Dominion Transmission Zone M-3 Process Evergreen Mills Series Reactor

**Need Number:** DOM-2022-0057

**Process Stage:**

Submission of Supplemental Project for Inclusion in the Local Plan – 02/21/2024

**Previously Presented:**

Need – 11/01/2022

Solution – 02/07/2023

**Project Driver:**

Operational Flexibility and Efficiency

**Specific Assumption Reference:**

See details on Operational Flexibility and Efficiency in Dominion’s Planning Assumptions presented in December 2021.

**Problem Statement:**

Near-term planning studies and Dominion Energy Operations Engineering studies have identified overloads on 230 kV Line #2172 (Brambleton – Evergreen Mills) for the loss of Line #2183 (Brambleton – Poland Road).

The Dominion Energy Operations team needs a temporary solution to avoid this overload on Line #2172 and accordingly provide flexibility for future construction outages.

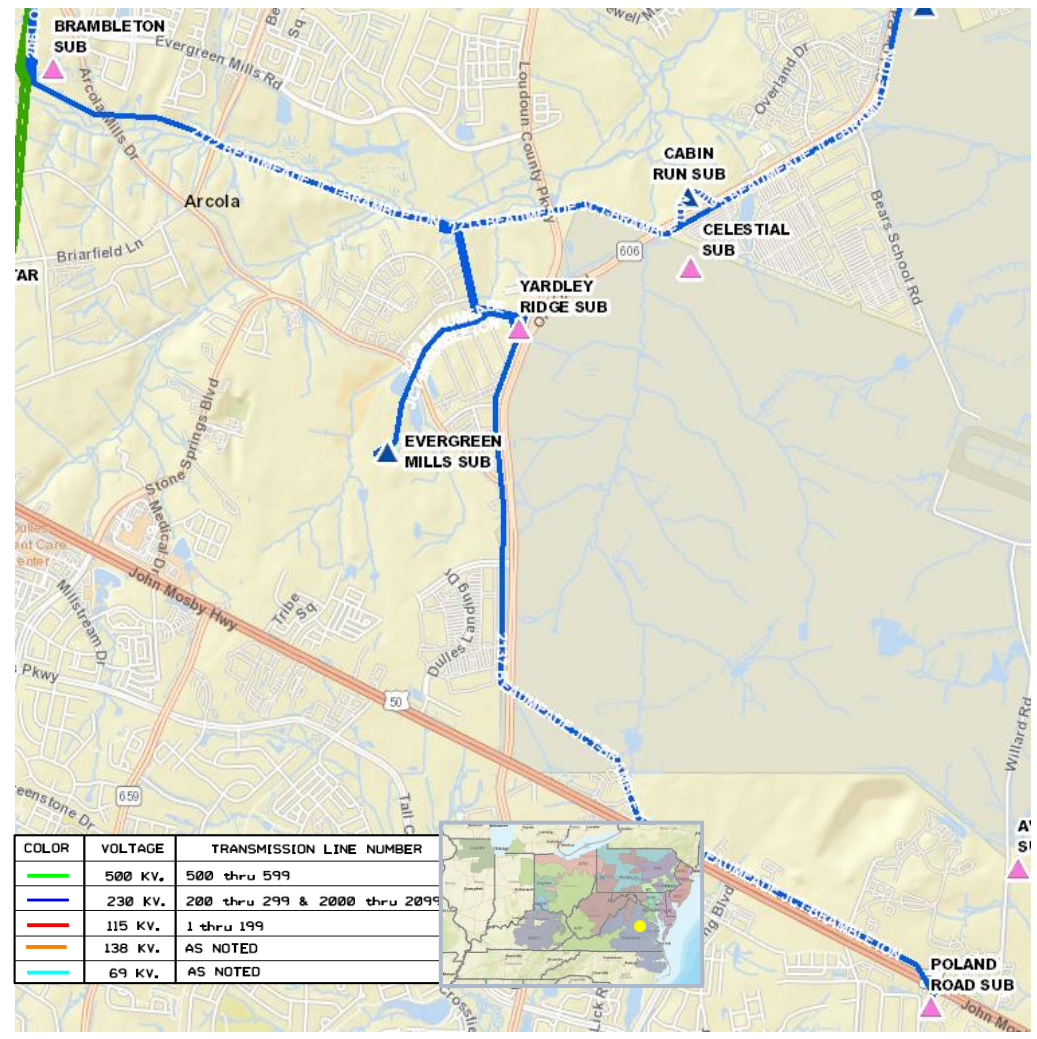

# Dominion Transmission Zone M-3 Process Evergreen Mills Series Reactor

**Need Number:** DOM-2022-0057

**Process Stage:**

Submission of Supplemental Project for Inclusion in the Local Plan – 02/21/2024

**Selected Solution:**

Install approximately 2.2  $\Omega$  series reactor at Evergreen Mills station on terminal of Line #2172.

**Estimated Cost:** \$3.0 M

**Projected In-Service:** 06/14/2023

**Supplemental Project ID:** s3051

**Project Status:** Complete

**Model:** 2027 RTEP

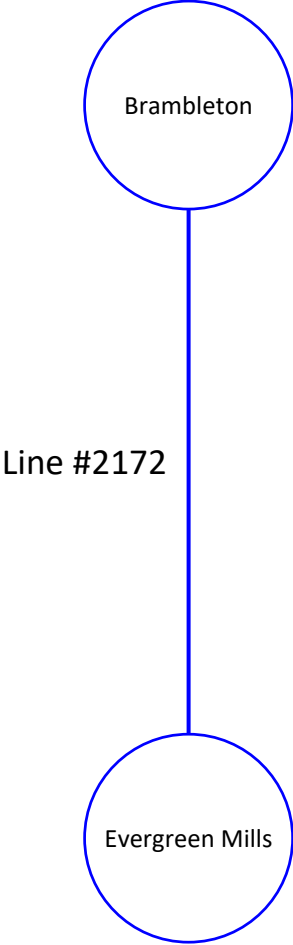



# Dominion Transmission Zone M-3 Process Pearsons Switch Replacement

**Need Number:** DOM-2022-0060

**Process Stage:**

Submission of Supplemental Project for Inclusion in the Local Plan – 02/21/2024

**Previously Presented:**

Need – 12/06/2022

Solution – 02/07/2023

**Project Driver:**

Equipment Material Condition, Performance and Risk

**Specific Assumption Reference:**

See details on Equipment Material Condition, Performance and Risk in Dominion’s Planning Assumptions presented in December 2021.

**Problem Statement:**

Dominion Energy has identified a need to replace two 230kV switches at Pearsons substation (207576 & 207579). These switches have become inoperable and can only be operated de-energized.

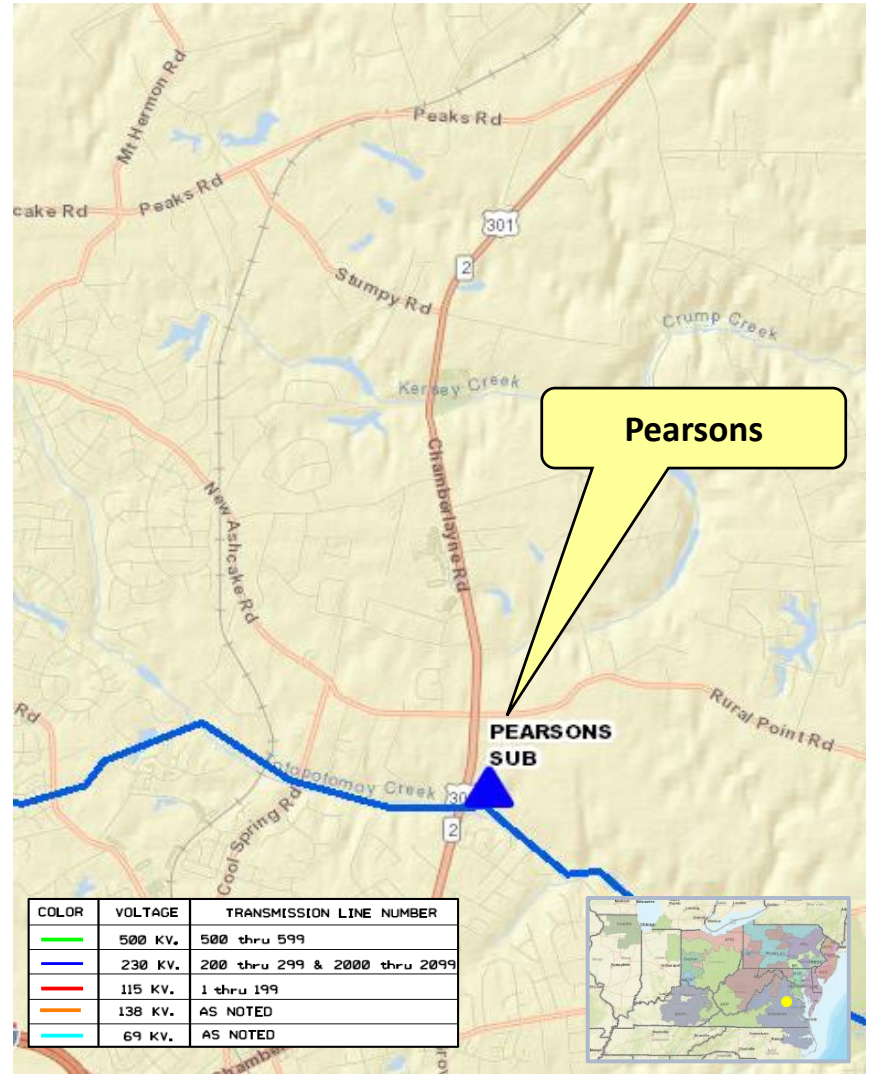

# Dominion Transmission Zone M-3 Process Pearsons Switch Replacement

**Need Number:** DOM-2022-0060

**Process Stage:**

Submission of Supplemental Project for Inclusion in the Local Plan – 02/21/2024

**Selected Solution:**

Replace the following 230kV switches 207576 and 207579 at Pearsons substation with 3000A switches on the existing backbone. The Pearsons to Elmont segment of Line #2075 Normal, Emergency and Load Dump ratings will increase as follows:

- Summer – From (876, 956, 1163) to (1047, 1047, 1204) MVA
- Winter – From (1068, 1123, 1334) to (1160, 1160, 1334) MVA

**Estimated Cost:** \$0.5 M

**Projected In-Service:** 10/31/2023

**Supplemental Project ID:** s3060

**Project Status:** Complete

**Model:** 2027 RTEP



# Dominion Transmission Zone M-3 Process Replace 115kV Ground Switches with Circuit Switchers -DEV

**Need Number:** DOM-2022-0061

**Process Stage:**

Submission of Supplemental Project for Inclusion in the Local Plan – 02/21/2024

**Previously Presented:**

Need – 12/14/2022

Solution – 03/16/2023

**Project Driver:**

Operational Flexibility and Efficiency

**Specific Assumption Reference:**

See details on Operational Flexibility and Efficiency in Dominion’s Planning Assumptions presented in December 2021.

**Problem Statement:**

Dominion has identified 7 5 substations that have legacy protection schemes on the 115kV high side of distribution transformers. These protection schemes utilize a ground switch and a motor operated switch on the high side of each transformer. For a fault in the transformer protection zone:

- The ground switch closes resulting in a bolted fault on the 115kV line
- This causes the transmission line breakers to open at the substation terminal ends
- The transformer motor operated high side switch opens isolating the transformer from the 115kV line and the terminal end breakers reclose to re-energize the 115kV line

These schemes are no longer standard protection due to the stress on the transmission equipment from the fault applied by the ground switch and the operation of the 115kV line interrupting service to all customers served by the line.

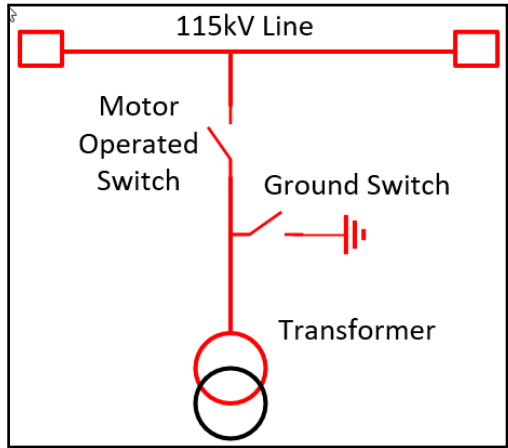

Substation	Tx #
Quantico	1 & 2
<del>Princess Anne</del>	<del>1</del>
Deep Creek	1 & 2
<del>Creswell</del>	<del>2</del>
Alexander Corner	1
Tunis	2
Brown Boveri	1

# Dominion Transmission Zone M-3 Process Replace 115kV Ground Switches with Circuit Switchers -DEV

**Need Number:** DOM-2022-0061

**Process Stage:**

Submission of Supplemental Project for Inclusion in the Local Plan – 02/21/2024

**Selected Solution:**

Remove the ground switches and install circuit switchers at 5 substations –

- Quantico Tx# 1 & 2
- Deep Creek Tx# 1 & 2
- Alexander Corner Tx# 1
- Tunis Tx# 2
- Brown Boveri Tx# 1

**Estimated Cost:** \$2.5 M

**Projected In-Service:** 04/30/2024

**Supplemental Project ID:** s3052

**Project Status:** Construction

**Model:** 2027 RTEP

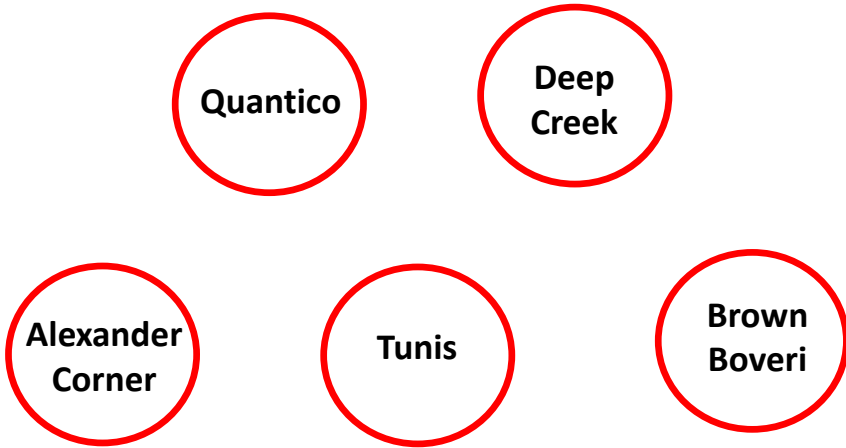

# Dominion Transmission Zone M-3 Process

## Starlight 230kV Delivery - DEV

**Need Number:** DOM-2023-0001

**Process Stage:**

Submission of Supplemental Project for Inclusion in the Local Plan – 02/21/2024

**Previously Presented:**

Need – 01/10/2023

Solution – 07/11/2023

**Project Driver:**

Customer Service

**Specific Assumption Reference:**

Customer load request will be evaluated per Dominion’s Facility Interconnection Requirements Document and Dominion’s Transmission Planning Criteria.

**Problem Statement:**

DEV has submitted a DP Request for a new substation (Starlight) in Loudoun County with a total load in excess of 100MW. Requested in-service date is 06/01/2028.

**Projected 2028 Load**

**Summer:** 10.0 MW

**Winter:** 0.0 MW

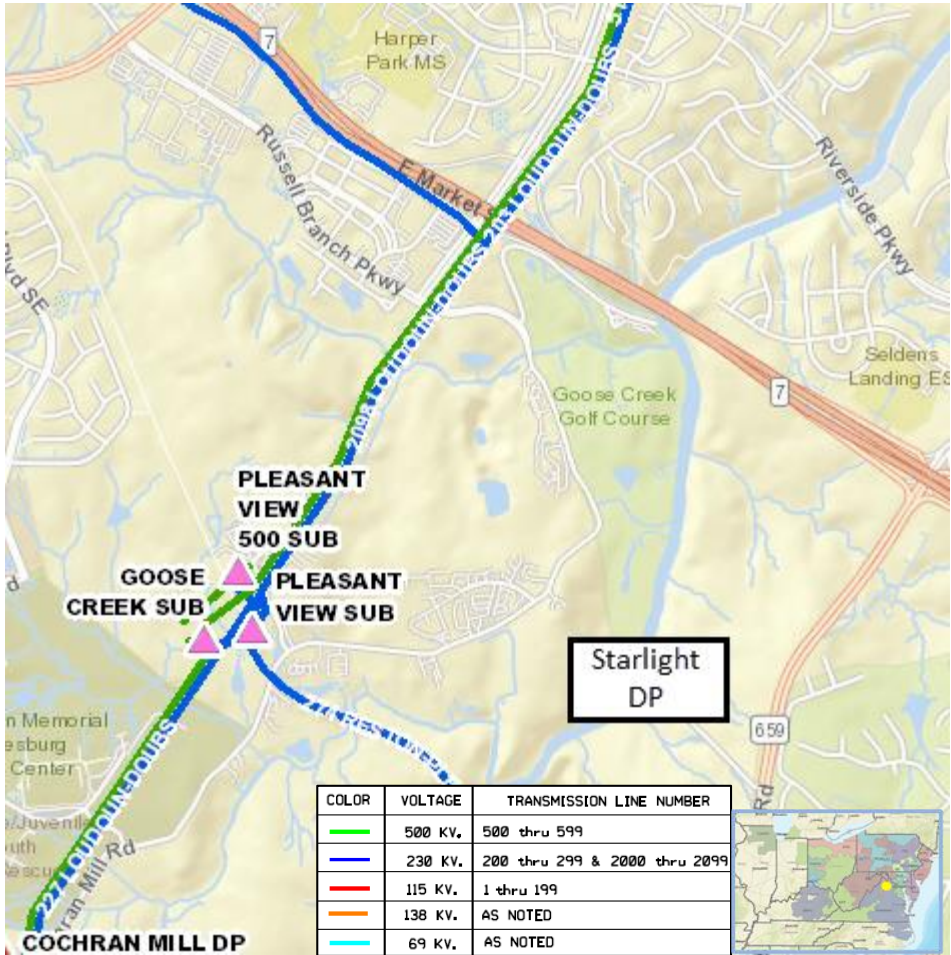

# Dominion Transmission Zone M-3 Process Starlight 230kV Delivery - DEV

**Need Number:** DOM-2023-0001

**Process Stage:**

Submission of Supplemental Project for Inclusion in the Local Plan – 02/21/2024

**Selected Solution:**

Interconnect the new substation by cutting two 230kV lines from Sycolin Creek Substation to Lunar Substation into proposed Starlight Substation. Lines to terminate in a 230kV six-breaker ring arrangement.

**Estimated Cost:** \$28.0 M

**Projected In-Service:** 06/01/2028

**Supplemental Project ID:** s3076

**Project Status:** Engineering

**Model:** 2027 RTEP

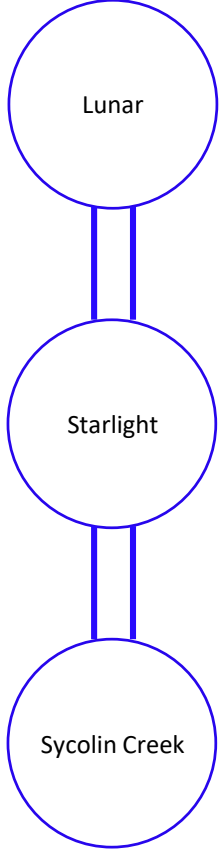

# Dominion Transmission Zone M-3 Process Roundtable - Add 3<sup>rd</sup> and 4<sup>th</sup> TX - DEV

**Need Number:** DOM-2023-0005

**Process Stage:**

Submission of Supplemental Project for Inclusion in the Local Plan – 02/21/2024

**Previously Presented:**

Need – 02/07/2023

Solution – 07/11/2023

**Project Driver:**

Customer Service

**Specific Assumption Reference:**

Customer load request will be evaluated per Dominion’s Facility Interconnection Requirements Document and Dominion’s Transmission Planning Criteria.

**Problem Statement:**

DEV Distribution has submitted a DP Request to add the 3<sup>rd</sup> and 4<sup>th</sup> distribution transformers at Roundtable Substation in Loudoun County. The new transformers are being driven by continued load growth in the area and contingency loading for loss of one of the existing transformers. Requested in-service date is 12/15/2024.

**Projected 2028 Load**

**Summer:** 141.0 MW

**Winter:** 138.0 MW

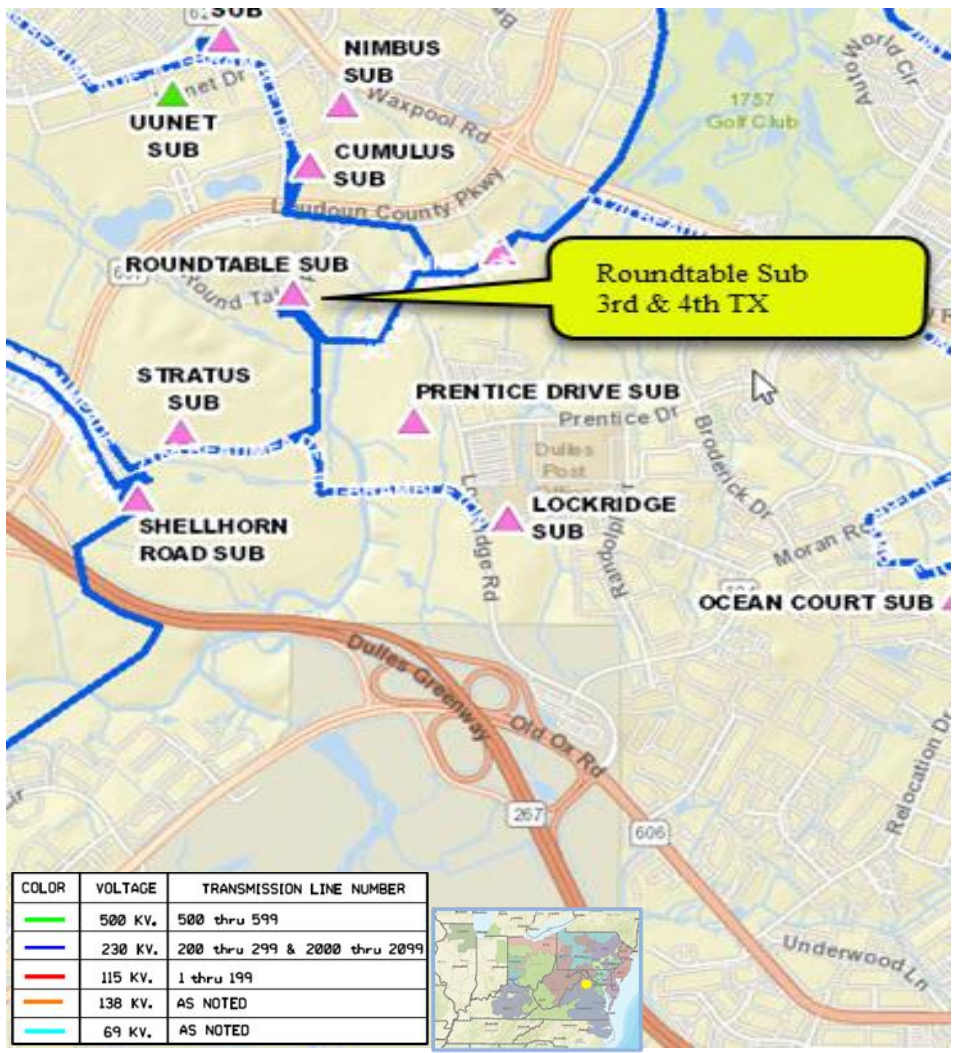

# Dominion Transmission Zone M-3 Process Roundtable - Add 3<sup>rd</sup> and 4<sup>th</sup> TX - DEV

**Need Number:** DOM-2023-0005

**Process Stage:**

Submission of Supplemental Project for Inclusion in the Local Plan – 02/21/2024

**Selected Solution:**

Install (2) 1200 Amp, 50kAIC circuit switchers and associated equipment (bus, relaying, etc.) to feed the new transformers at Roundtable.

**Estimated Cost:** \$1.0 M

**Projected In-Service:** 12/15/2024

**Supplemental Project ID:** s3053

**Project Status:** Engineering

**Model:** 2027 RTEP

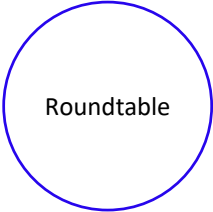



# Dominion Transmission Zone M-3 Process

## Bear Run 230kV Delivery - DEV

**Need Number:** DOM-2023-0007

**Process Stage:**

Submission of Supplemental Project for Inclusion in the Local Plan – 02/21/2024

**Previously Presented:**

Need – 03/07/2023

Solution – 04/11/2023

**Project Driver:**

Customer Service

**Specific Assumption Reference:**

Customer load request will be evaluated per Dominion’s Facility Interconnection Requirements Document and Dominion’s Transmission Planning Criteria.

**Problem Statement:**

NOVEC has submitted a Delivery Point (DP) Request stating that it is expanding Cub Run Substation in Fairfax County and the total load will exceed 100MW. Requested in-service date is 3/15/2024.

**Projected 2028 Load**

**Summer:** 90.0 MW

**Winter:** 90.0 MW

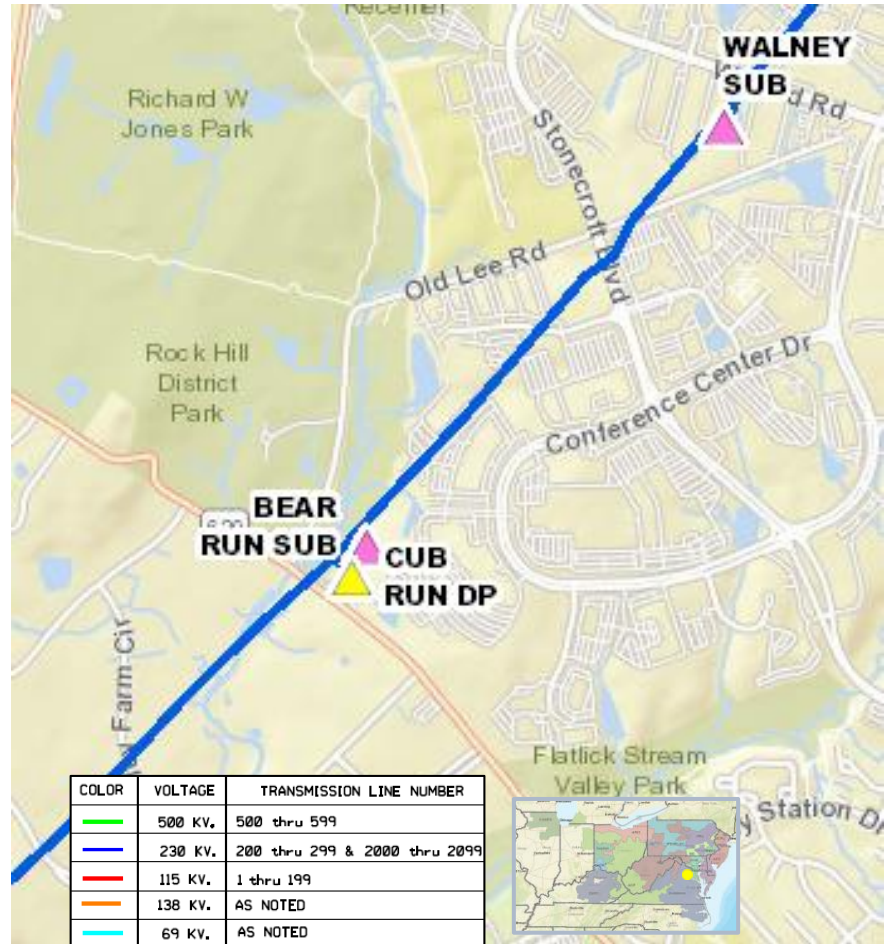

# Dominion Transmission Zone M-3 Process

## Bear Run 230kV Delivery - DEV

**Need Number:** DOM-2023-0007

**Process Stage:**

Submission of Supplemental Project for Inclusion in the Local Plan – 02/21/2024

**Selected Solution:**

Interconnect the new substation by cutting and extending Line #265 (Bull Run - Sully) to the proposed Bear Run Substation. Lines to terminate in a 230kV four-breaker ring arrangement with an ultimate arrangement of a six-breaker ring.

**Estimated Cost:** \$24.5 M

**Projected In-Service:** 03/15/2024

**Supplemental Project ID:** s3062

**Project Status:** Engineering

**Model:** 2027 RTEP

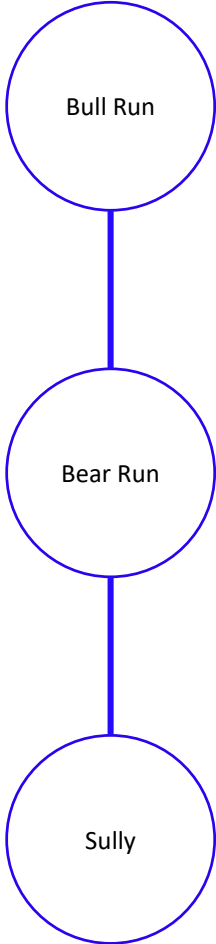

# Dominion Transmission Zone M-3 Process Foster Drive 230kV Delivery - CoM

**Need Number:** DOM-2023-0008

**Process Stage:**

Submission of Supplemental Project for Inclusion in the Local Plan – 02/21/2024

**Previously Presented:**

Need – 03/07/2023

Solution – 05/09/2023

**Project Driver:**

Customer Service

**Specific Assumption Reference:**

Customer load request will be evaluated per Dominion’s Facility Interconnection Requirements Document and Dominion’s Transmission Planning Criteria.

**Problem Statement:**

The City of Manassas has submitted a DP Request for a new substation (Foster Drive) to serve a data center complex in Manassas with a total load in excess of 100 MW.

Requested in-service date is 03/31/2025.

**Projected 2028 Load**

**Summer:** 260.0 MW

**Winter:** 260.0 MW

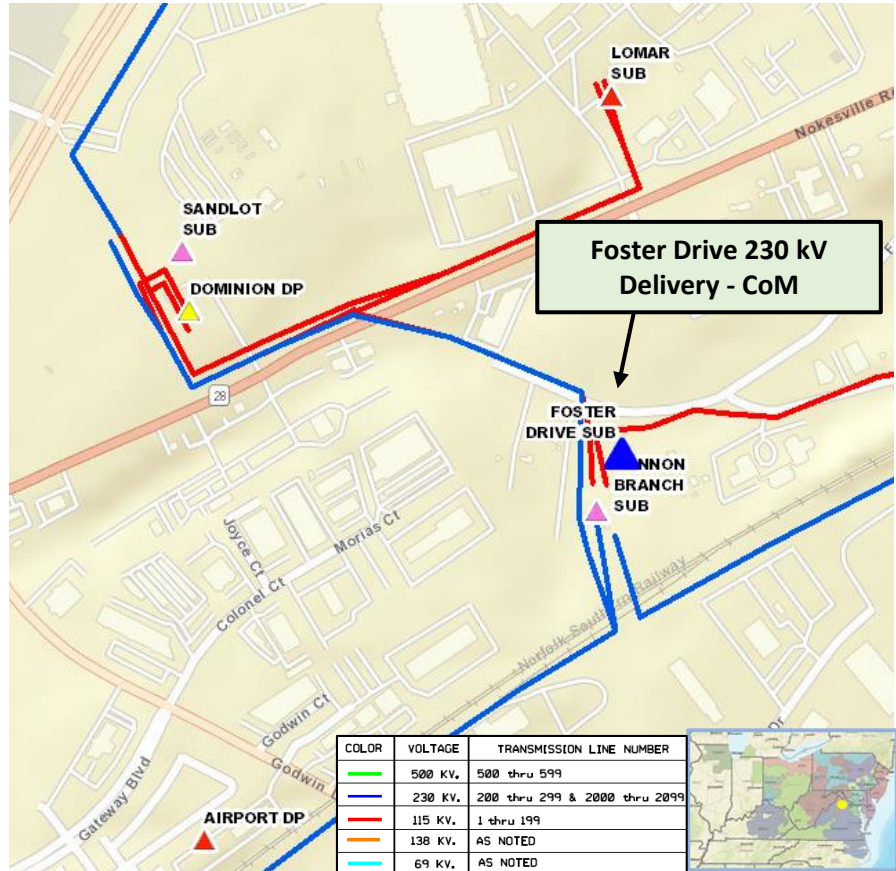

# Dominion Transmission Zone M-3 Process Foster Drive 230kV Delivery - CoM

**Need Number:** DOM-2023-0008

**Process Stage:**

Submission of Supplemental Project for Inclusion in the Local Plan – 02/21/2024

**Selected Solution:**

Interconnect the new substation by cutting and extending Line #2243 (Sandlot – Cannon Branch) to the proposed Foster Drive Substation. Lines to terminate into a 230 kV four-breaker ring arrangement with an ultimate arrangement of a six-breaker ring.

**Estimated Cost:** \$15.3 M (Total)

Transmission: \$0.3 M

Substation: \$15.0 M

**Projected In-Service:** 03/31/2025

**Supplemental Project ID:** s3064

**Project Status:** Engineering

**Model:** 2027 RTEP

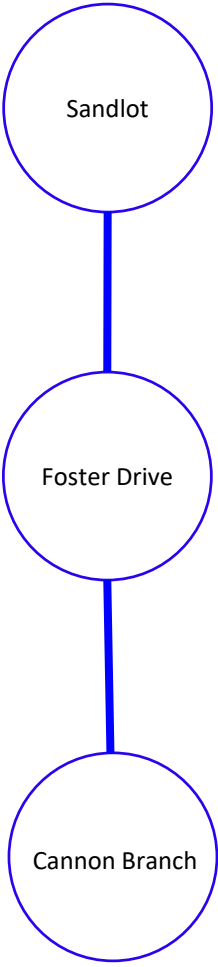

# Dominion Transmission Zone M-3 Process

## Daves Store 230kV Delivery - DEV

**Need Number:** DOM-2023-0009

**Process Stage:**

Submission of Supplemental Project for Inclusion in the Local Plan – 02/21/2024

**Previously Presented:**

Need – 03/07/2023

Solution – 06/06/2023

**Project Driver:**

Customer Service

**Specific Assumption Reference:**

Customer load request will be evaluated per Dominion’s Facility Interconnection Requirements Document and Dominion’s Transmission Planning Criteria.

**Problem Statement:**

DEV Distribution has submitted a DP Request for a new substation (Daves Store) to serve a data center complex in Gainesville with a total load in excess of 100 MW. Requested in-service date is 06/01/2025.

**Projected 2028 Load**

**Summer:** 264.0 MW

**Winter:** 228.0 MW

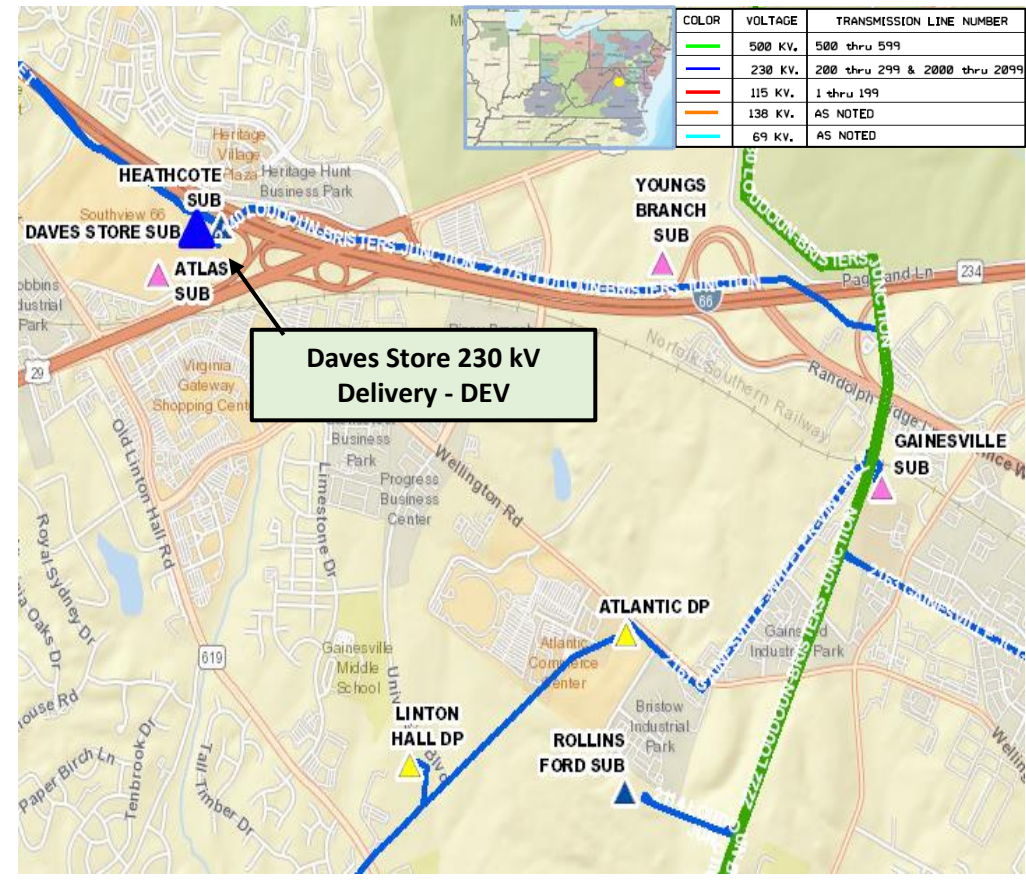

# Dominion Transmission Zone M-3 Process

## Daves Store 230kV Delivery - DEV

**Need Number:** DOM-2023-0009

**Process Stage:**

Submission of Supplemental Project for Inclusion in the Local Plan – 02/21/2024

**Selected Solution:**

Interconnect the new substation by extending approximately 300’ of 230 kV GIL from the existing Heathcote substation to the proposed Daves Store Substation. Lines to terminate into a GIS 230 kV four-breaker arrangement expandable to an ultimate of eight 230 kV GIS breakers in a breaker-and-a-half scheme.

**Estimated Cost:** \$40.0 M

**Projected In-Service:** 06/01/2025

**Supplemental Project ID:** s3068.1

**Project Status:** Engineering

**Model:** 2027 RTEP

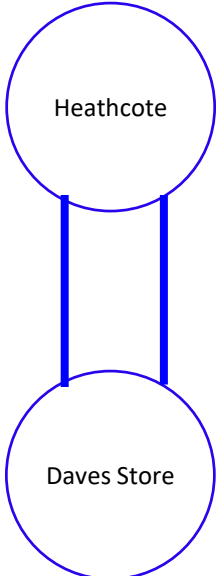

# Dominion Transmission Zone M-3 Process Do No Harm (DNH) Analysis

**Need Number:** DOM-2023-0009-DNH

**Process Stage:**

Submission of Supplemental Project for Inclusion in the Local Plan – 02/21/2024

**Presentation Date:**

DNH – 06/06/2023

**Supplemental Project Driver:**

Do No Harm Analysis

**Specific Assumption Reference:**

Customer load request will be evaluated per Dominion’s Facility Interconnection Requirements Document and Dominion’s Transmission Planning Criteria.

**Problem Statement:**

PJM has identified a 300 MW load drop violation due to the loss of the following separate facilities in the 2023 Do-No-Harm analysis:

- Daves Store + Youngs Branch + Catharpin DP
  - N-1-1 Contingency Scenario: DVP\_P1-2: LN 2140 and DVP\_P1-2: LN 2176

The violations are caused by previously presented Supplemental Project DOM-2023-0009 in the Dominion Zone.

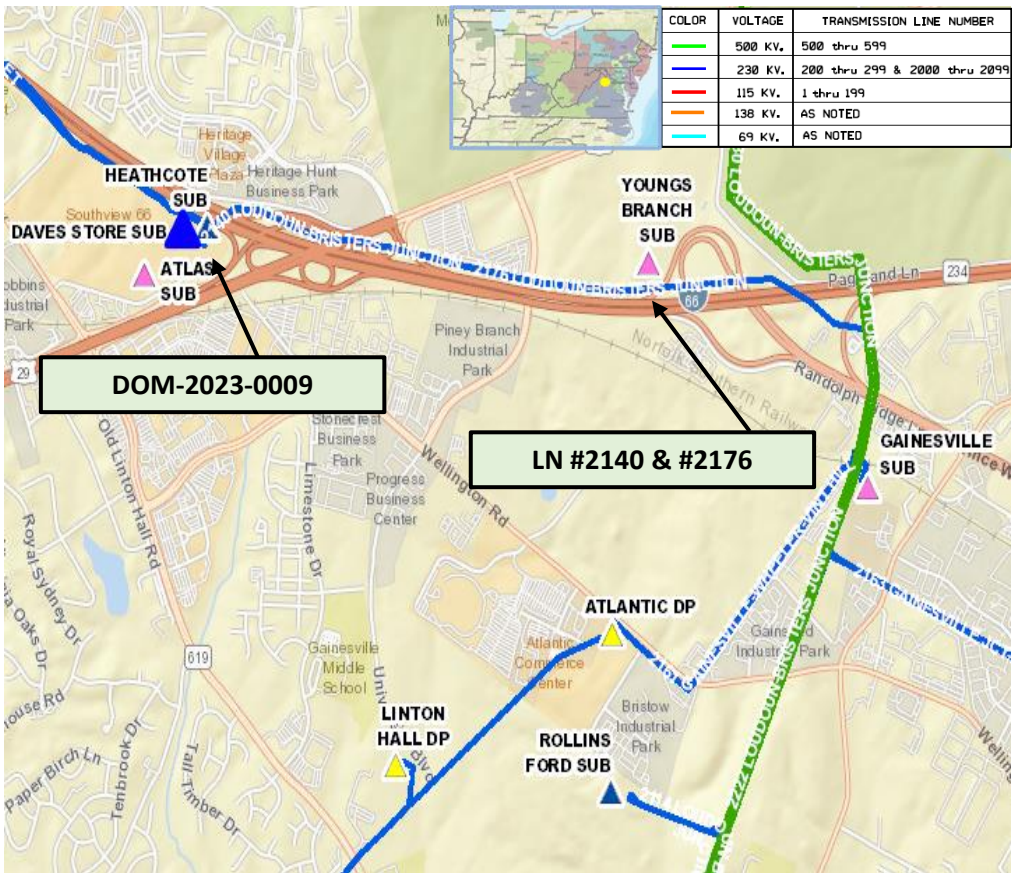

# Dominion Transmission Zone M-3 Process Do No Harm (DNH) Analysis

**Need Number:** DOM-2023-0009-DNH

**Process Stage:**

Submission of Supplemental Project for Inclusion in the Local Plan – 02/21/2024

**Selected Solution:**

Rebuild approx. 7.9 miles of double-circuit Line from Ox to Braddock and partial Line#2097 (Ox-Idylwood) to current 230kV standards. The normal summer rating of the line conductor will be 1573 MVA.

<b>Estimated Cost:</b>	\$33.5M (Total)
Transmission Line	\$13.5M
Real Estate	\$18.5M
Substation	\$ 1.5M

**Projected In-Service:** 12/31/2026

**Supplemental Project ID:** s3068.2

**Project Status:** Conceptual

**Model:** 2027 RTEP

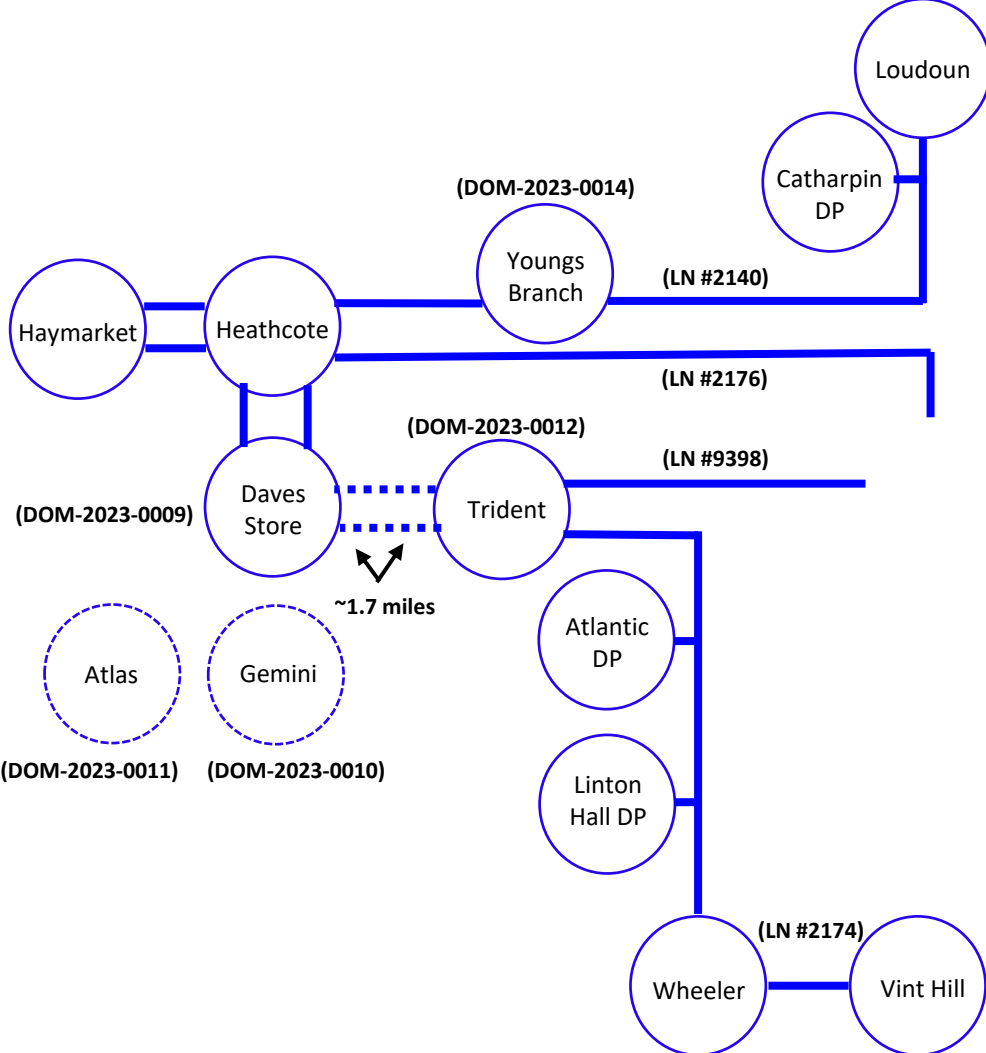



# Dominion Transmission Zone M-3 Process Gemini 230kV Delivery - DEV

**Need Number:** DOM-2023-0010

**Process Stage:**

Submission of Supplemental Project for Inclusion in the Local Plan – 02/21/2024

**Previously Presented:**

Need – 03/07/2023

Solution – 06/06/2023

**Project Driver:**

Customer Service

**Specific Assumption Reference:**

Customer load request will be evaluated per Dominion’s Facility Interconnection Requirements Document and Dominion’s Transmission Planning Criteria.

**Problem Statement:**

DEV Distribution has submitted a DP Request for a new substation (Gemini) to serve a data center complex in Gainesville with a total load in excess of 100 MW. Requested in-service date is 08/01/2026.

**Projected 2028 Load**

**Summer:** 258.0 MW

**Winter:** 210.0 MW

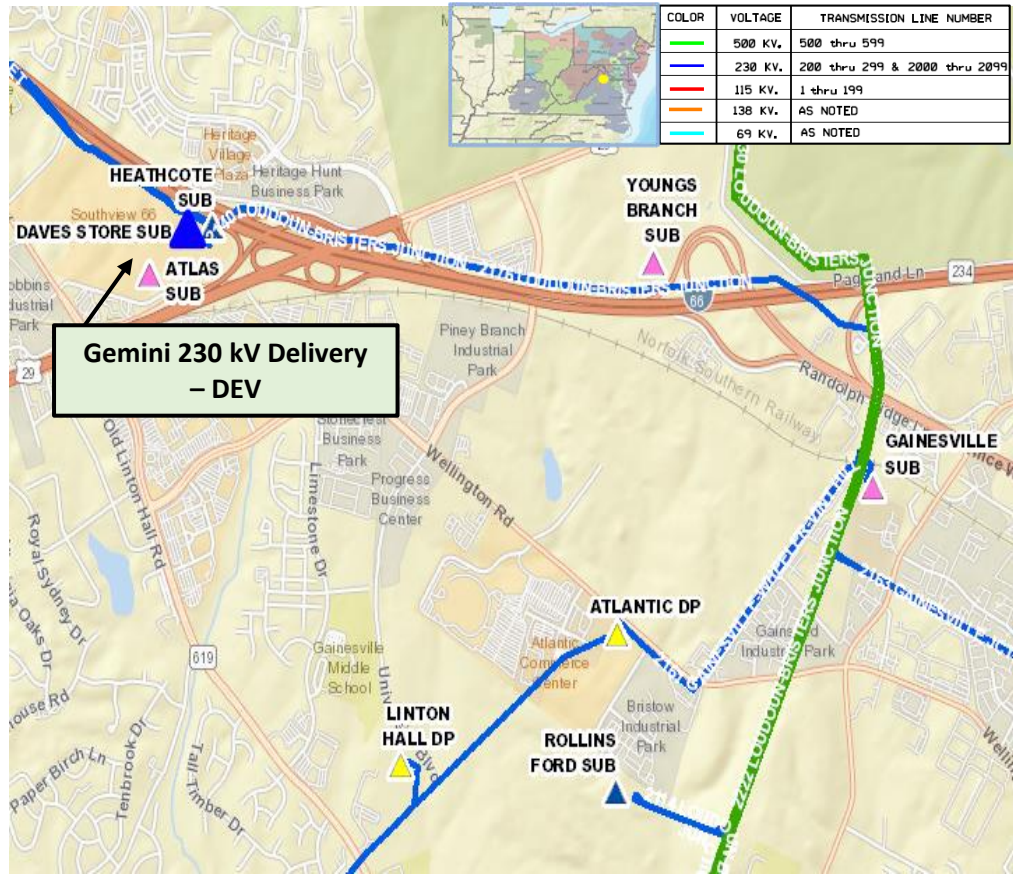

# Dominion Transmission Zone M-3 Process

## Gemini 230kV Delivery - DEV

**Need Number:** DOM-2023-0010

**Process Stage:**

Submission of Supplemental Project for Inclusion in the Local Plan – 02/21/2024

**Selected Solution:**

Interconnect the new substation by extending approx. 600' of (2) new 230 kV lines from Daves Store to the proposed Gemini Substation. Lines to terminate into a 230 kV four-breaker arrangement with an ultimate of six.

**Estimated Cost:** \$15.3 M (Total)

Transmission: \$0.30 M

Substation: \$15.0 M

**Projected In-Service:** 08/01/2026

**Supplemental Project ID:** s3069

**Project Status:** Engineering

**Model:** 2027 RTEP

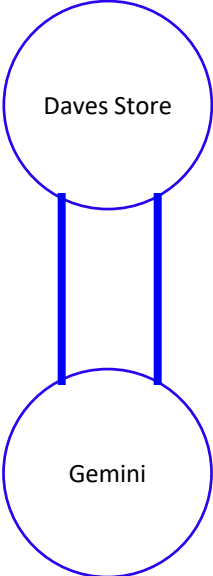

# Dominion Transmission Zone M-3 Process Atlas 230kV Delivery - DEV

**Need Number:** DOM-2023-0011

**Process Stage:**

Submission of Supplemental Project for Inclusion in the Local Plan – 02/21/2024

**Previously Presented:**

Need – 03/07/2023

Solution – 06/06/2023

**Project Driver:**

Customer Service

**Specific Assumption Reference:**

Customer load request will be evaluated per Dominion’s Facility Interconnection Requirements Document and Dominion’s Transmission Planning Criteria.

**Problem Statement:**

DEV Distribution has submitted a DP Request for a new substation (Atlas) to serve a data center complex in Gainesville with a total load in excess of 100 MW.

Requested in-service date is 04/01/2028.

**Projected 2028 Load**

**Summer:** 70.0 MW

**Winter:** 0.0 MW

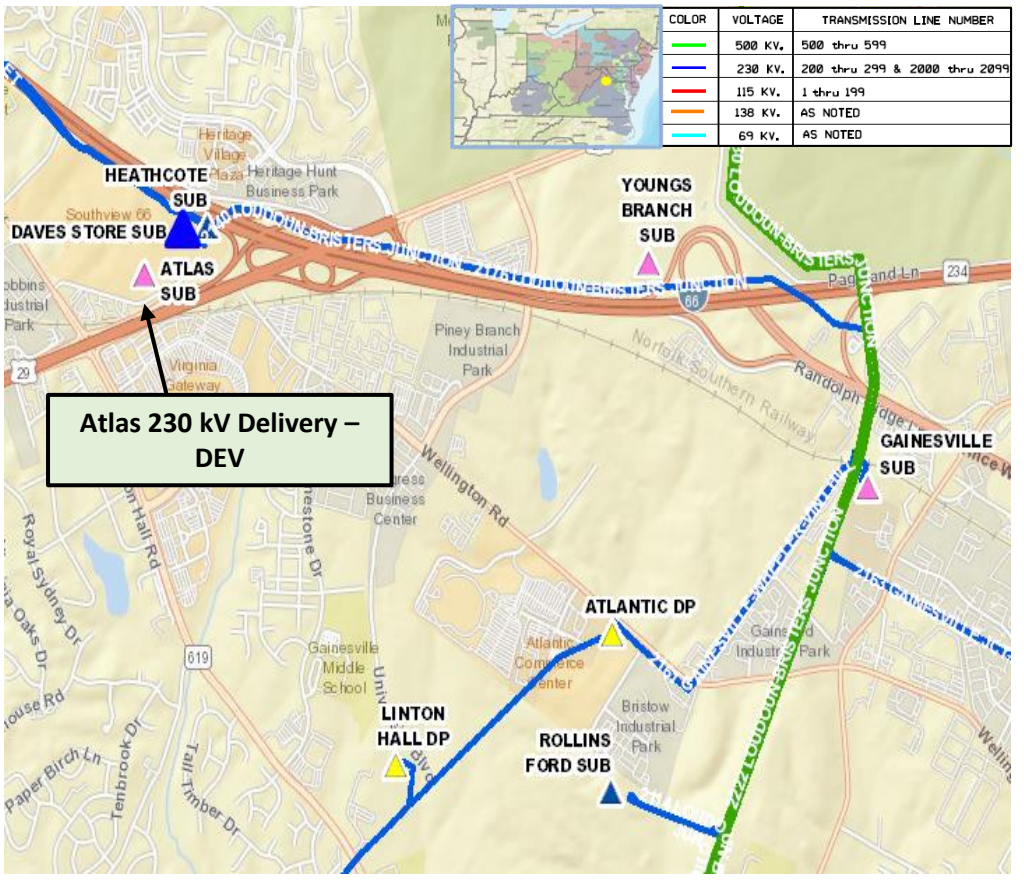

# Dominion Transmission Zone M-3 Process Atlas 230kV Delivery - DEV

**Need Number:** DOM-2023-0011

**Process Stage:**

Submission of Supplemental Project for Inclusion in the Local Plan – 02/21/2024

**Selected Solution:**

Interconnect the new substation by extending approx. 450’ of (1) new 230 kV line from Gemini to the proposed Atlas Substation. Re-terminate (1) of the 230 kV segments from Daves Store to Trident (DOM-2023-0009-DNH) into Atlas, extending the segment by approx. 1200’. The 230 kV lines will terminate into a 230 kV four-breaker arrangement expandable to an ultimate of six.

**Estimated Cost:** \$15.4 M (Total)

Transmission: \$0.40 M

Substation: \$15.0 M

**Projected In-Service:** 04/01/2028

**Supplemental Project ID:** s3070

**Project Status:** Engineering

**Model:** 2027 RTEP

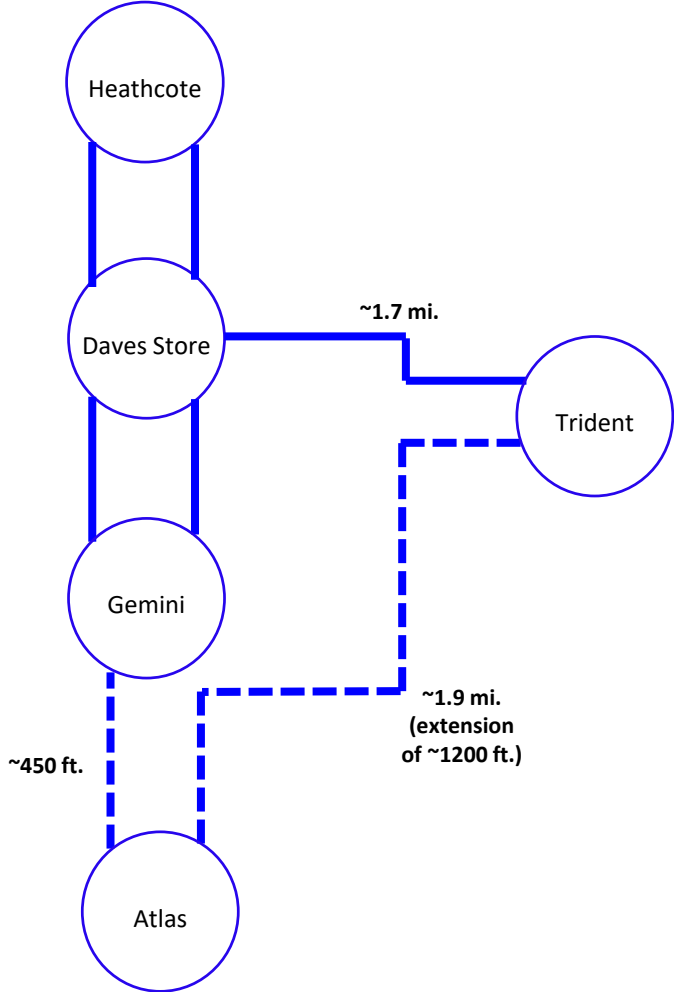

# Dominion Transmission Zone M-3 Process Trident 230kV Delivery - NOVEC

**Need Number:** DOM-2023-0012

**Process Stage:**

Submission of Supplemental Project for Inclusion in the Local Plan – 02/21/2024

**Previously Presented:**

Need – 03/07/2023

Solution – 06/06/2023

**Project Driver:**

Customer Service

**Specific Assumption Reference:**

Customer load request will be evaluated per Dominion’s Facility Interconnection Requirements Document and Dominion’s Transmission Planning Criteria.

**Problem Statement:**

NOVEC has submitted a DP Request for a new substation (Trident) to serve a data center complex in Bristow with a total load in excess of 100 MW. Requested in-service date is 09/01/2025.

**Projected 2028 Load**

**Summer:** 153.3 MW

**Winter:** 125.3 MW

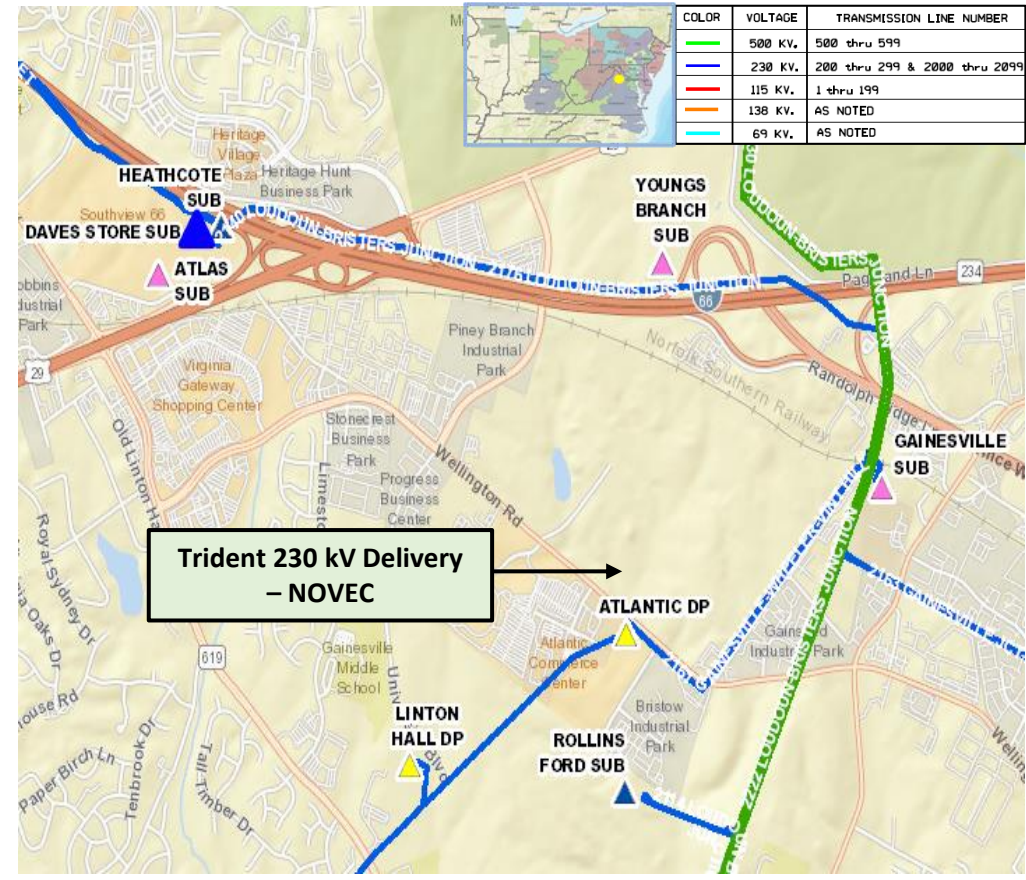

# Dominion Transmission Zone M-3 Process Trident 230kV Delivery - NOVEC

**Need Number:** DOM-2023-0012

**Process Stage:**

Submission of Supplemental Project for Inclusion in the Local Plan – 02/21/2024

**Selected Solution:**

Interconnect the new substation by cutting and extending Line #2161 (Gainesville – Wheeler) to the proposed Trident Substation. Lines to terminate into a 230 kV six-breaker ring arrangement.

**Estimated Cost:** \$15.75 M (Total)

Transmission: \$0.75 M

Substation: \$15.0 M

**Projected In-Service:** 09/01/2025

**Supplemental Project ID:** s3071

**Project Status:** Engineering

**Model:** 2027 RTEP

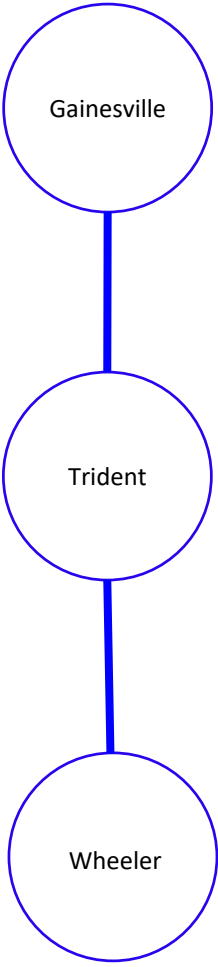

# Dominion Transmission Zone M-3 Process Youngs Branch - Add 3<sup>rd</sup>, 4<sup>th</sup>, and 5<sup>th</sup> TX - DEV

**Need Number:** DOM-2023-0014

**Process Stage:**

Submission of Supplemental Project for Inclusion in the Local Plan – 02/21/2024

**Previously Presented:**

Need – 03/07/2023

Solution – 05/09/2023

**Project Driver:**

Customer Service

**Specific Assumption Reference:**

Customer load request will be evaluated per Dominion’s Facility Interconnection Requirements Document and Dominion’s Transmission Planning Criteria.

**Problem Statement:**

DEV Distribution has submitted a DP Request to add a 3<sup>rd</sup>, 4<sup>th</sup>, and 5<sup>th</sup> distribution transformer at Youngs Branch Substation in Gainesville. The new transformers are being driven by significant area load growth.

Requested in-service date is 07/01/2024.

**Projected 2028 Load**

**Summer:** 270.0 MW

**Winter:** 270.0 MW

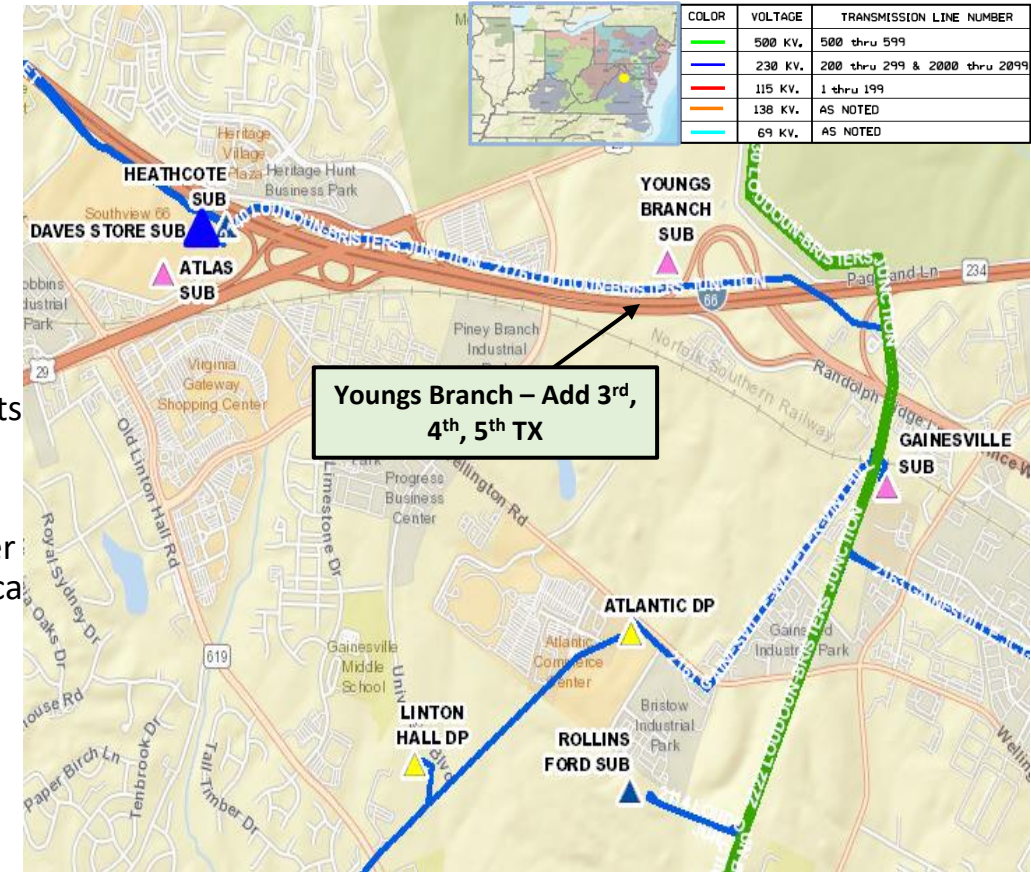

# Dominion Transmission Zone M-3 Process Youngs Branch - Add 3<sup>rd</sup>, 4<sup>th</sup>, and 5<sup>th</sup> TX - DEV

**Need Number:** DOM-2023-0014

**Process Stage:**

Submission of Supplemental Project for Inclusion in the Local Plan – 02/21/2024

**Selected Solution:**

Install (3) 1200 Amp, 50kAIC circuit switchers and associated equipment (bus, relaying, etc.) to feed the new transformers at Youngs Branch.

**Estimated Cost:** \$3.0 M

**Projected In-Service:** 07/01/2024

**Supplemental Project ID:** s3065

**Project Status:** Engineering

**Model:** 2027 RTEP

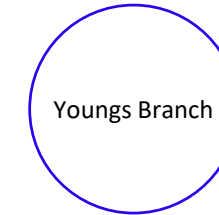



# Dominion Transmission Zone M-3 Process Firetower Rd 230kV Delivery - DEV

**Need Number:** DOM-2023-0015

**Process Stage:**

Submission of Supplemental Project for Inclusion in the Local Plan – 02/21/2024

**Previously Presented:**

Need – 03/07/2023

Solution – 04/11/2023

**Project Driver:**

Customer Service

**Specific Assumption Reference:**

Customer load request will be evaluated per Dominion’s Facility Interconnection Requirements Document and Dominion’s Transmission Planning Criteria.

**Problem Statement:**

NCEMC has submitted a delivery point request for a new substation (Firetower Rd) to serve a gas compression facility in Ahoskie, NC. The total load is less than 100 MW. The customer requests service by December 31, 2023.

**Projected 2028 Load**

**Summer:** 8.1 MW

**Winter:** 8.1 MW

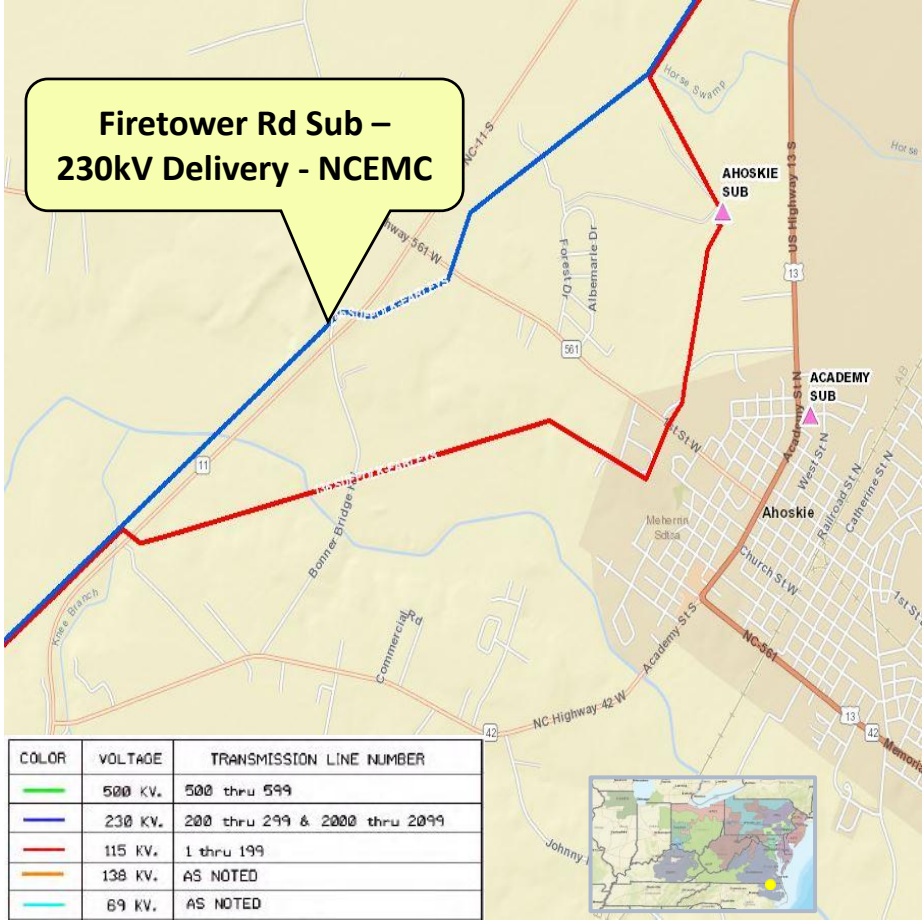

# Dominion Transmission Zone M-3 Process Firetower Rd 230kV Delivery - DEV

**Need Number:** DOM-2023-0015

**Process Stage:**

Submission of Supplemental Project for Inclusion in the Local Plan – 02/21/2024

**Selected Solution:**

Tap Line #246 (Earleys – Suffolk) near structure 246/290 and extend a single circuit 230kV line to Firetower Road sub.

**Estimated Cost:** \$5.0 M (Total)

Transmission: \$4.0 M

Substation: \$1.0 M

**Projected In-Service:** 02/29/2024

**Supplemental Project ID:** s3063

**Project Status:** Construction

**Model:** 2027 RTEP

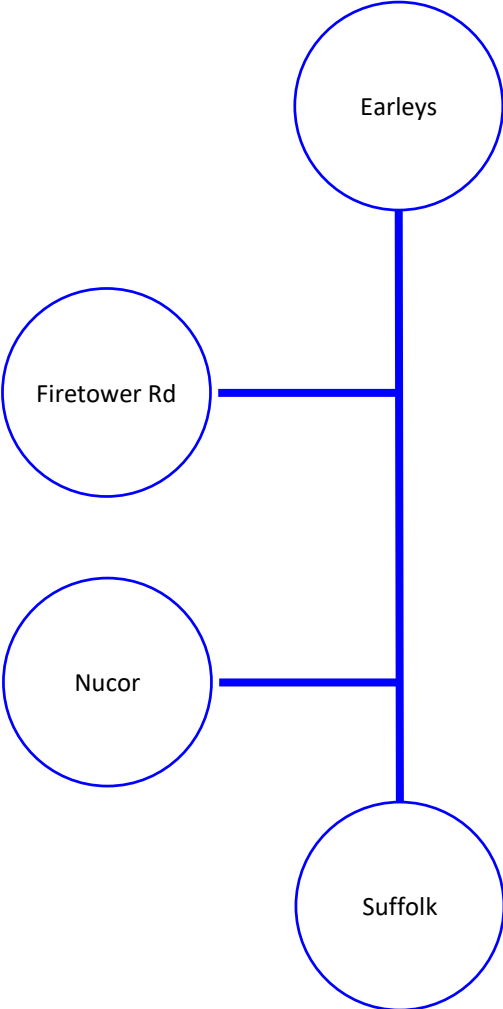

# Dominion Transmission Zone M-3 Process Southall 230kV Delivery - REC

**Need Number:** DOM-2023-0017

**Process Stage:**

Submission of Supplemental Project for Inclusion in the Local Plan – 02/21/2024

**Previously Presented:**

Need – 03/07/2023

Solution – 06/06/2023

**Project Driver:**

Customer Service

**Specific Assumption Reference:**

Customer load request will be evaluated per Dominion’s Facility Interconnection Requirements Document and Dominion’s Transmission Planning Criteria.

**Problem Statement:**

Rappahannock Electric Cooperative (REC) has submitted a DP Request for a new substation (Southall) to serve a data center in Louisa County with a total load in excess of 100 MW. The requested in-service date is 05/01/2025.

**Projected 2028 Load**

**Summer:** 220.0 MW

**Winter:** 193.0 MW

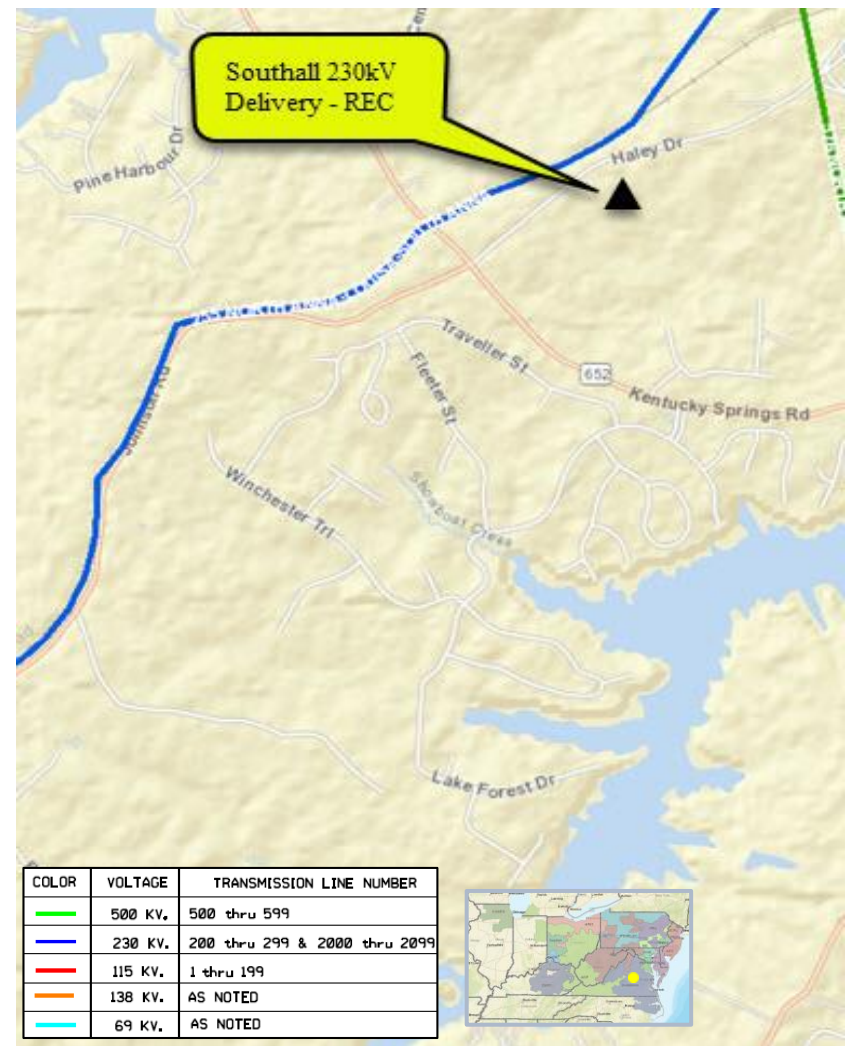

# Dominion Transmission Zone M-3 Process Southall 230kV Delivery - REC

**Need Number:** DOM-2023-0017

**Process Stage:**

Submission of Supplemental Project for Inclusion in the Local Plan – 02/21/2024

**Selected Solution:**

Interconnect the new substation by cutting and extending Line #255 (North Anna - Desper) to the proposed Southall Substation. Lines to terminate in a 230kV four-breaker ring arrangement with an ultimate arrangement of a six-breaker ring.

**Estimated Cost:** \$55.0 M

**Projected In-Service:** 05/01/2025

**Supplemental Project ID:** s3072

**Project Status:** Engineering

**Model:** 2027 RTEP



# Dominion Transmission Zone M-3 Process Spartan 230kV Delivery Point - DEV

**Need Number:** DOM-2023-0018

**Process Stage:**

Submission of Supplemental Project for Inclusion in the Local Plan – 02/21/2024

**Previously Presented:**

Need – 04/11/2023

Solution – 05/09/2023

**Project Driver:**

Customer Service

**Specific Assumption Reference:**

Customer load request will be evaluated per Dominion’s Facility Interconnection Requirements Document and Dominion’s Transmission Planning Criteria.

**Problem Statement:**

DEV Distribution has submitted a DP Request for a new substation (Spartan) to serve a new data center in Stafford County with a total load in excess of 100 MW. The requested in-service date is 05/02/2025.

**Projected 2028 Load**

**Summer:** 110.0 MW

**Winter:** 105.0 MW

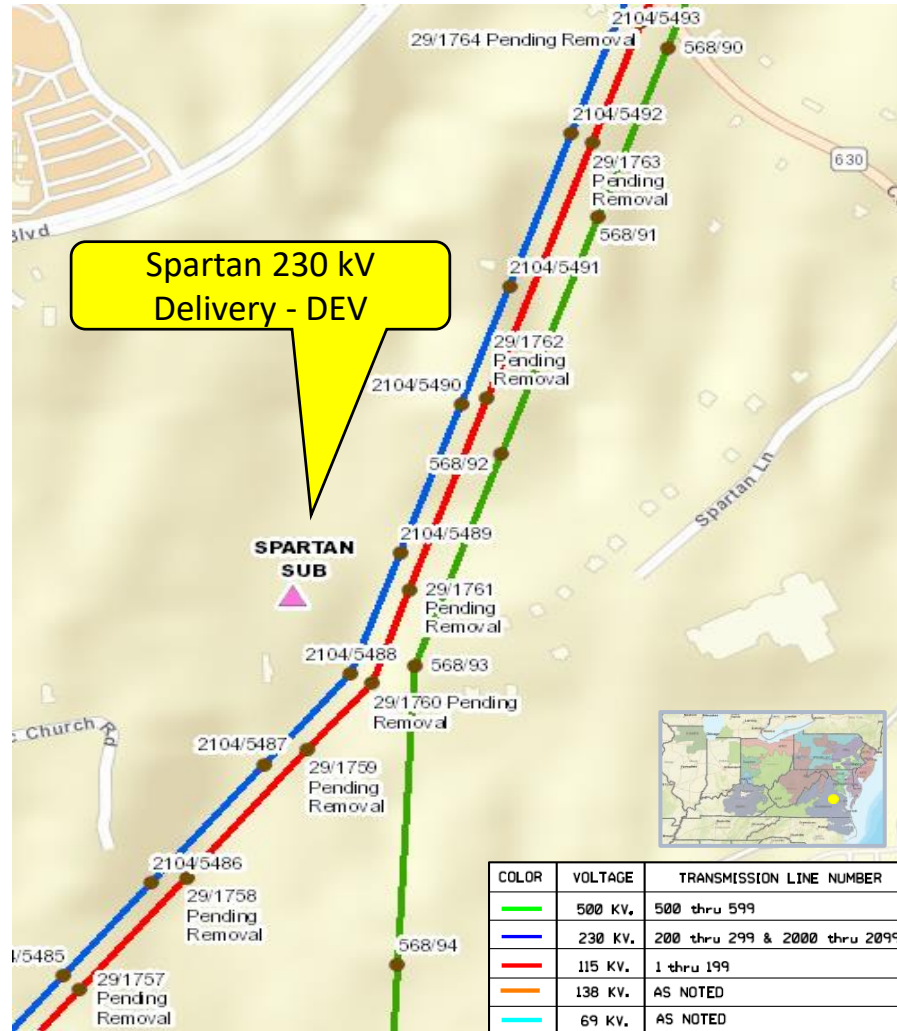

# Dominion Transmission Zone M-3 Process Spartan 230kV Delivery Point - DEV

**Need Number:** DOM-2023-0018

**Process Stage:**

Submission of Supplemental Project for Inclusion in the Local Plan – 02/21/2024

**Selected Solution:**

Interconnect the new substation by cutting and extending Line #2104 to the proposed Spartan Substation. Lines to terminate in a 230kV four-breaker ring arrangement with an ultimate arrangement of a six-breaker ring.

**Estimated Cost:** \$48.0 M (Total)

Transmission: \$12.0 M

Substation: \$36.0 M

**Projected In-Service:** 05/02/2025

**Supplemental Project ID:** s3066

**Project Status:** Engineering

**Model:** 2027 RTEP

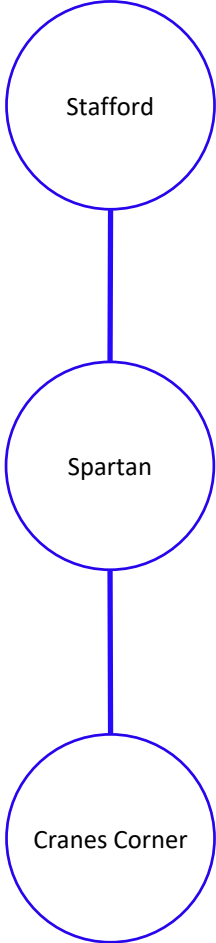

# Dominion Transmission Zone M-3 Process Buttermilk - Add 3<sup>rd</sup> and 4<sup>th</sup> TX - DEV

**Need Number:** DOM-2023-0019

**Process Stage:**  
Submission of Supplemental Project for Inclusion in the Local Plan – 02/21/2024

**Previously Presented:**  
Need – 03/07/2023  
Solution – 07/11/2023

**Project Driver:**  
Customer Service

**Specific Assumption Reference:**  
Customer load request will be evaluated per Dominion’s Facility Interconnection Requirements Document and Dominion’s Transmission Planning Criteria.

**Problem Statement:**  
DEV Distribution has submitted a DP Request to add the 3<sup>rd</sup> and 4<sup>th</sup> distribution transformers at Buttermilk Substation in Loudoun County. The new transformer is being driven by continued load growth in the area. Requested in-service date is 12/15/2024.

**Projected 2028 Load**  
**Summer:** 147.0 MW  
**Winter:** 146.0 MW

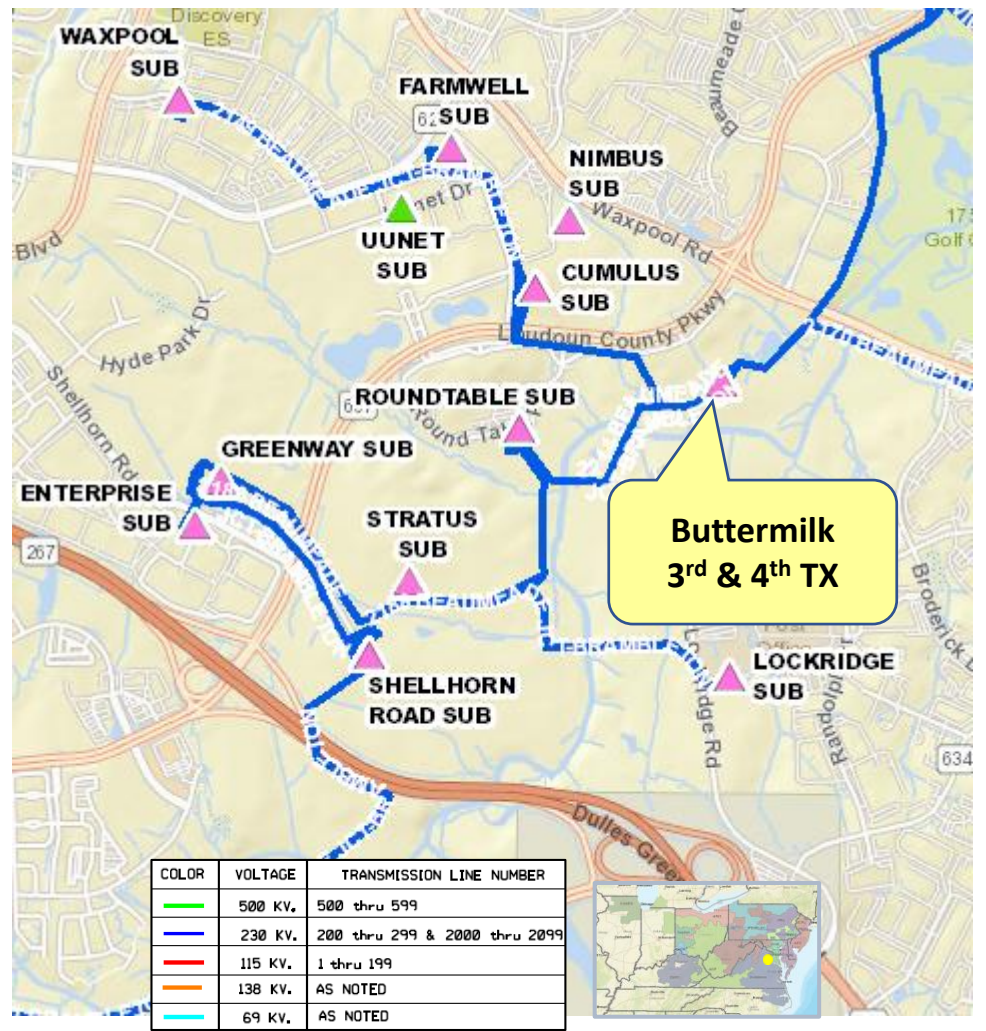

# Dominion Transmission Zone M-3 Process Buttermilk - Add 3<sup>rd</sup> and 4<sup>th</sup> TX - DEV

**Need Number:** DOM-2023-0019

**Process Stage:**

Submission of Supplemental Project for Inclusion in the Local Plan – 02/21/2024

**Selected Solution:**

Install (2) 1200 Amp, 50kAIC circuit switchers and associated equipment (bus, relaying, etc.) to feed the new transformers at Buttermilk.

**Estimated Cost:** \$1.0 M

**Projected In-Service:** 12/15/2024

**Supplemental Project ID:** s3077

**Project Status:** Engineering

**Model:** 2027 RTEP

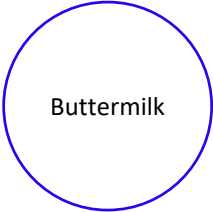



# Dominion Transmission Zone M-3 Process Broderick Drive 230kV Delivery - DEV

**Need Number:** DOM-2023-0020

**Process Stage:**  
Submission of Supplemental Project for Inclusion in the Local Plan – 02/21/2024

**Previously Presented:**  
Need – 03/07/2023  
Solution – 08/08/2023

**Project Driver:**  
Customer Service

**Specific Assumption Reference:**  
Customer load request will be evaluated per Dominion’s Facility Interconnection Requirements Document and Dominion’s Transmission Planning Criteria.

**Problem Statement:**  
DEV Distribution has submitted a DP Request for a new substation (Broderick Drive) to serve a data center campus in Loudoun County with a total load in excess of 100 MW. Requested in-service date is 03/01/2026.

**Projected 2028 Load**  
Summer: 112.0 MW  
Winter: 72.0 MW

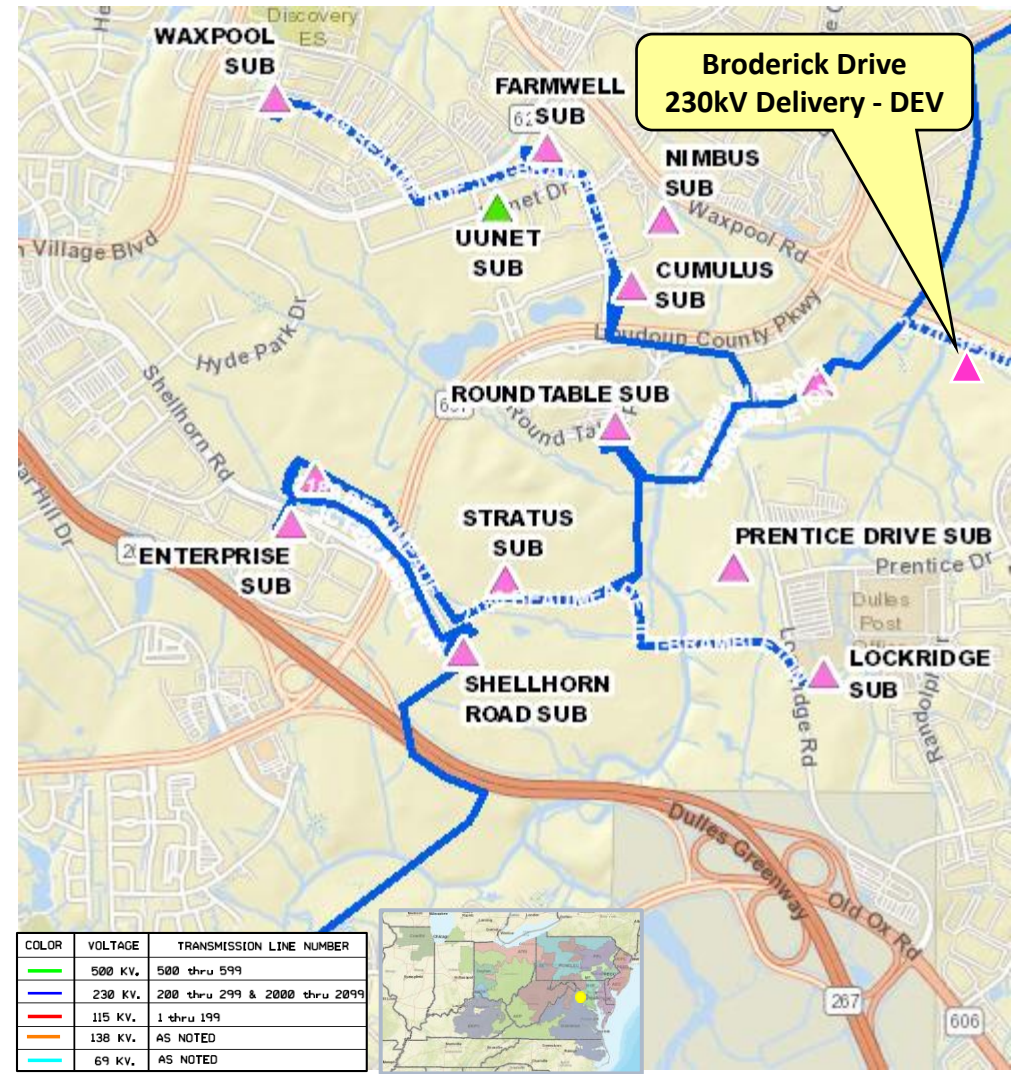

# Dominion Transmission Zone M-3 Process Broderick Drive 230kV Delivery - DEV

**Need Number:** DOM-2023-0020

**Process Stage:**

Submission of Supplemental Project for Inclusion in the Local Plan – 02/21/2024

**Selected Solution:**

Interconnect the new substation by cutting and extending Line #2170 (Buttermilk- Pacific) to the proposed Broderick Drive Substation. Lines to terminate in a 230kV four-breaker ring arrangement.

**Estimated Cost:** \$24.5 M

**Projected In-Service:** 03/01/2026

**Supplemental Project ID:** s3079

**Project Status:** Engineering

**Model:** 2027 RTEP

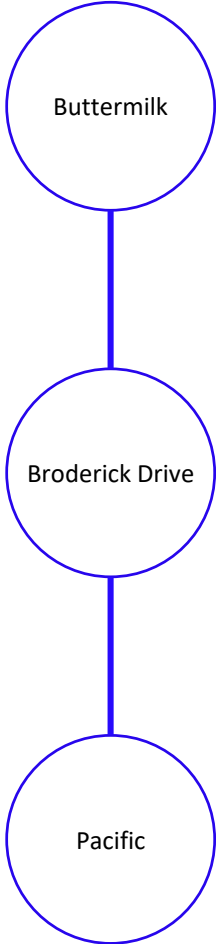

# Dominion Transmission Zone M-3 Process

## Otterdam 230kV Delivery - MEC

**Need Number:** DOM-2023-0027

**Process Stage:**

Submission of Supplemental Project for Inclusion in the Local Plan – 02/21/2024

**Previously Presented:**

Need – 04/11/2023

Solution – 05/09/2023

**Project Driver:**

Customer Service

**Specific Assumption Reference:**

Customer load request will be evaluated per Dominion’s Facility Interconnection Requirements Document and Dominion’s Transmission Planning Criteria.

**Problem Statement:**

ODEC on behalf of Mecklenburg Electric Cooperative (MEC) has submitted a delivery point request for a new delivery point at the MAMaC site in Greensville County, VA. MEC is requesting to construct a transmission line under the economic development legislative pilot program for business parks. The total load is in excess of 100 MW. The customer requests service by December 31, 2026.

**Projected 2028 Load**

**Summer:** 80.0 MW

**Winter:** 80.0 MW

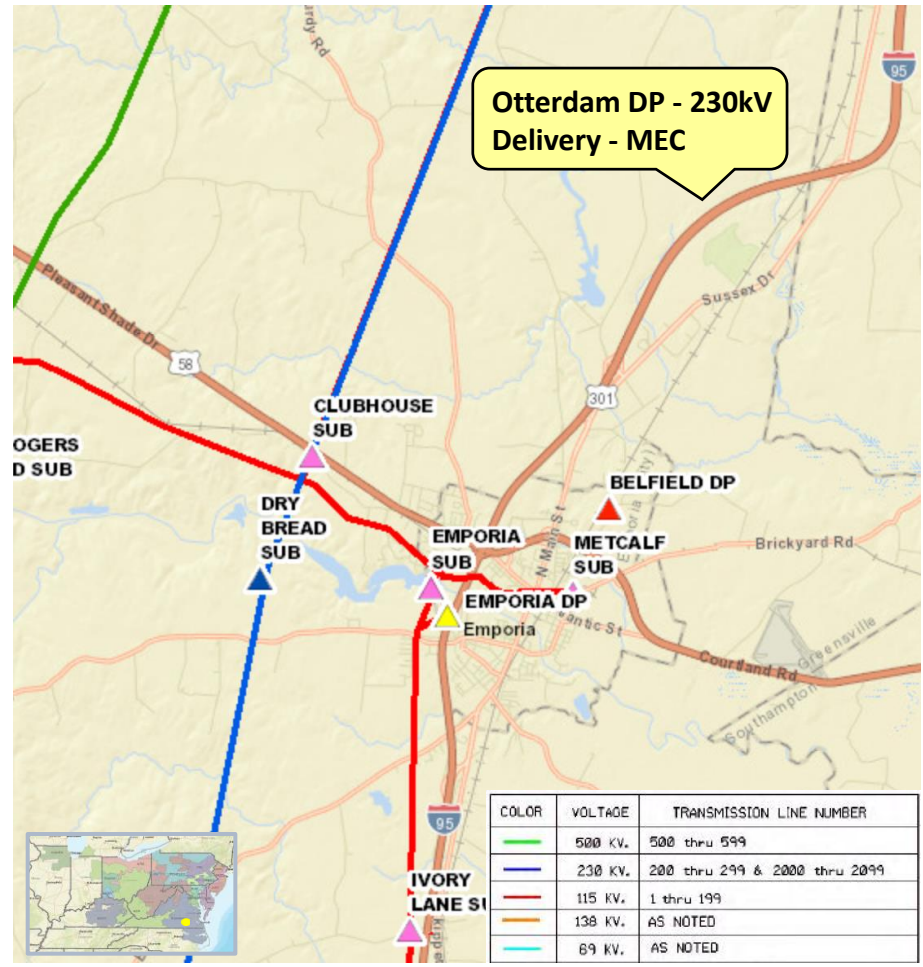

# Dominion Transmission Zone M-3 Process Otterdam 230kV Delivery - MEC

**Need Number:** DOM-2023-0027

**Process Stage:**

Submission of Supplemental Project for Inclusion in the Local Plan – 02/21/2024

**Selected Solution:**

- Split Line #238 (Clubhouse - Carson) near structure 238/11 and extend double circuit 230kV lines for approx. 3 miles to the proposed Otterdam Substation.
- Terminate the two 230kV lines into 4 breaker ring bus to create a Clubhouse - Otterdam line and a Carson - Otterdam line.

**Estimated Cost:** \$25.0 M (Total)

Transmission: \$13.0 M

Substation: \$12.0 M

**Projected In-Service:** 12/31/2026

**Supplemental Project ID:** s3067

**Project Status:** Engineering

**Model:** 2027 RTEP

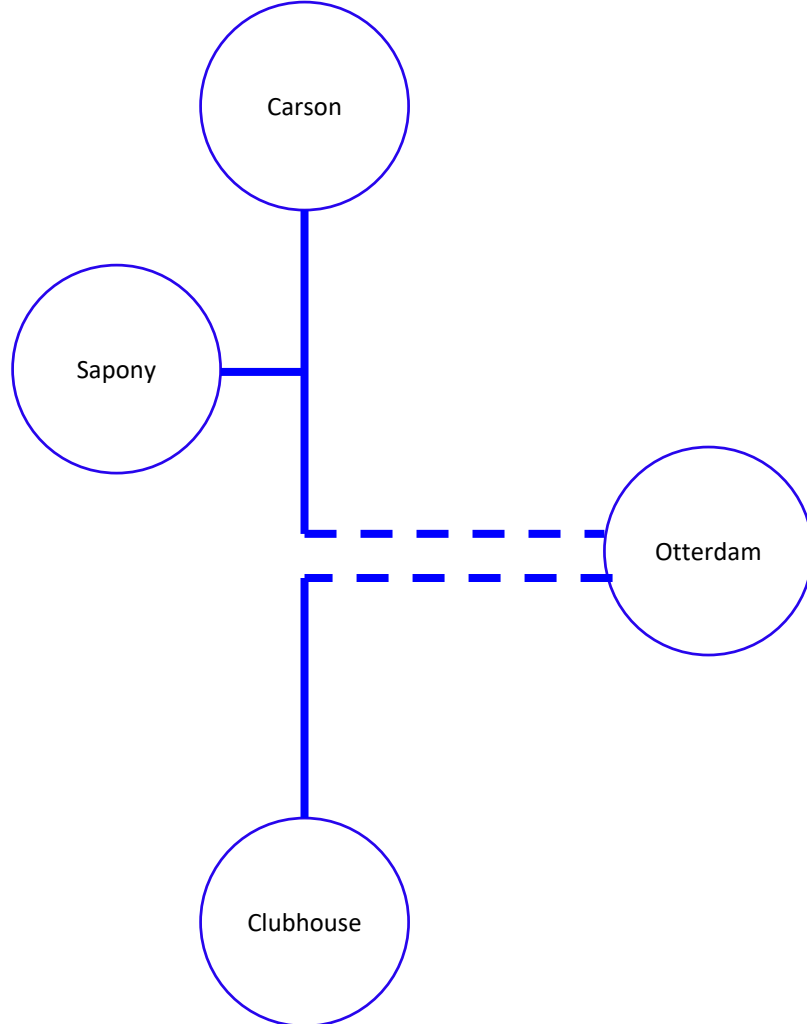

# Dominion Transmission Zone M-3 Process Upgrade Verona TX#1 - DEV

**Need Number:** DOM-2023-0028

**Process Stage:**

Submission of Supplemental Project for Inclusion in the Local Plan – 02/21/2024

**Previously Presented:**

Need – 04/20/2023

Solution – 07/20/2023

**Project Driver:**

Customer Service

**Specific Assumption Reference:**

Customer load request will be evaluated per Dominion’s Facility Interconnection Requirements Document and Dominion’s Transmission Planning Criteria.

**Problem Statement:**

Dominion Distribution has submitted a delivery point request to upgrade TX #1 at Verona substation in Augusta County, Virginia. The upgrade is being driven by increasing customer load. Requested in-service date is 06/30/2024.

**Projected 2028 Load**

**Summer:** 36.2 MW

**Winter:** 36.2 MW

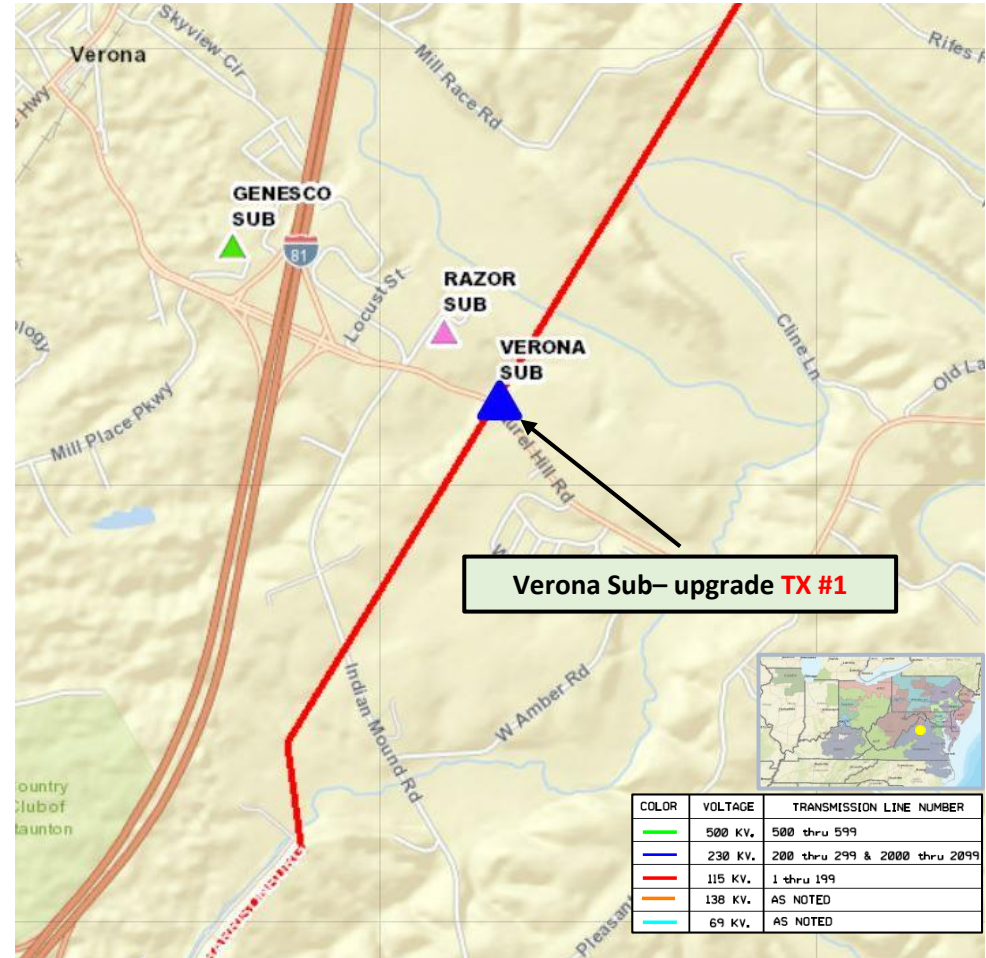

# Dominion Transmission Zone M-3 Process Upgrade Verona TX#1 - DEV

**Need Number:** DOM-2023-0028

**Process Stage:**

Submission of Supplemental Project for Inclusion in the Local Plan – 02/21/2024

**Selected Solution:**

Replace the fuse H111 on high-side of Verona transformer #1 with a 1200A, 25kA circuit switcher and upgrade H114 with a motor operated switch.

**Estimated Cost:** \$0.35 M

**Projected In-Service:** 06/30/2024

**Supplemental Project ID:** s3055

**Project Status:** Engineering

**Model:** 2027 RTEP



# Dominion Transmission Zone M-3 Process Weyers Cave – Install 2<sup>nd</sup> TX - DEV

**Need Number:** DOM-2023-0030

**Process Stage:**

Submission of Supplemental Project for Inclusion in the Local Plan – 02/21/2024

**Previously Presented:**

Need – 04/20/2023

Solution – 07/20/2023

**Project Driver:**

Customer Service

**Specific Assumption Reference:**

Customer load request will be evaluated per Dominion’s Facility Interconnection Requirements Document and Dominion’s Transmission Planning Criteria.

**Problem Statement:**

Dominion Distribution has submitted a delivery point request to install a 2<sup>nd</sup> transformer at Weyers Cave Substation in Augusta County, Virginia. The upgrade is being driven by increasing customer load. Requested in-service date is 12/31/2024.

**Projected 2028 Load**

**Summer:** 29.2 MW

**Winter:** 29.2 MW

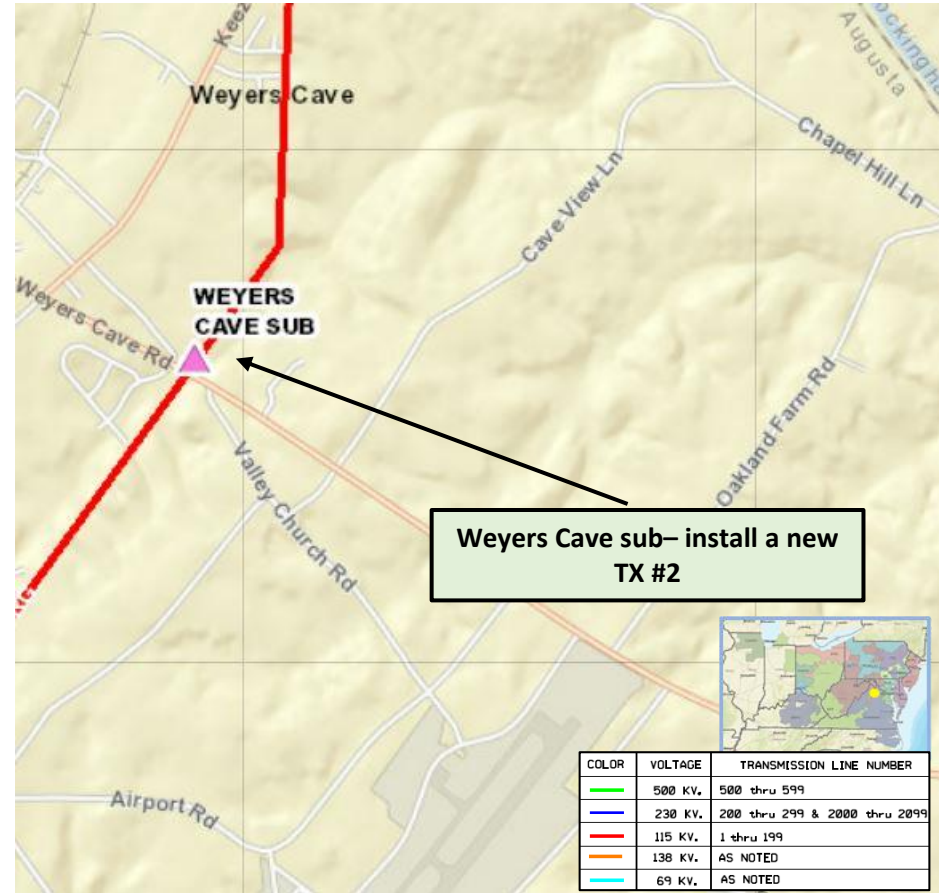

# Dominion Transmission Zone M-3 Process

## Weyers Cave – Install 2<sup>nd</sup> TX - DEV

**Need Number:** DOM-2023-0030

**Process Stage:**

Submission of Supplemental Project for Inclusion in the Local Plan – 02/21/2024

**Selected Solution:**

Install a 1200A, 25kA circuit switcher, high side switch, bus work and associated equipment on the 115kV high-side of the new transformer.

**Estimated Cost:** \$0.85 M

**Projected In-Service:** 12/31/2024

**Supplemental Project ID:** s3078

**Project Status:** Engineering

**Model:** 2027 RTEP

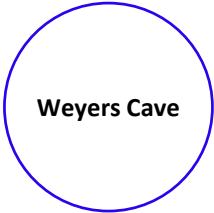



# Dominion Transmission Zone M-3 Process Cumulus 230kV Delivery- Add 5<sup>th</sup> TX - DEV

**Need Number:** DOM-2023-0032

**Process Stage:**

Submission of Supplemental Project for Inclusion in the Local Plan – 02/21/2024

**Previously Presented:**

Need – 06/06/2023

Solution – 07/11/2023

**Project Driver:**

Customer Service

**Specific Assumption Reference:**

Customer load request will be evaluated per Dominion’s Facility Interconnection Requirements Document and Dominion’s Transmission Planning Criteria.

**Problem Statement:**

DEV Distribution has submitted a DP Request to add a 5th distribution transformer at Cumulus Substation in Loudoun County. The new 84 MVA transformer is being driven by continued load growth in the area and contingency loading for loss of one of the existing transformers. Requested in-service date is 06/01/2025.

**Projected 2028 Load**

**Summer:** 268.2 MW

**Winter:** 260.3 MW

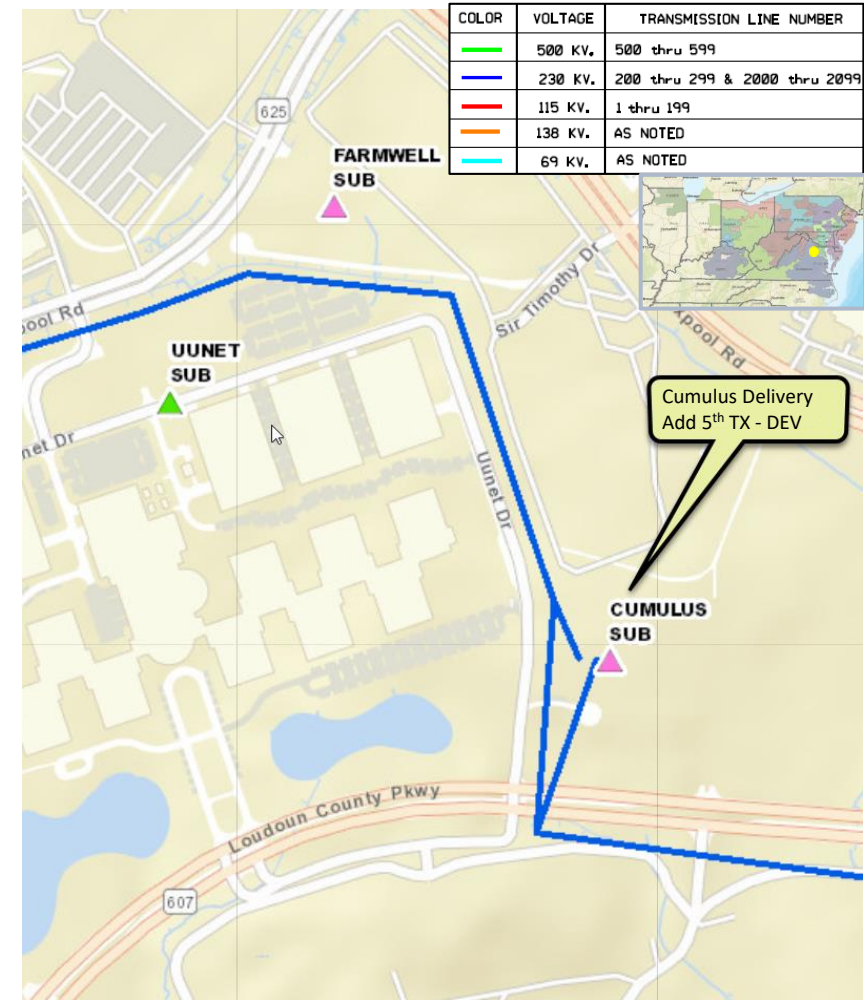

# Dominion Transmission Zone M-3 Process Cumulus 230kV Delivery- Add 5<sup>th</sup> TX - DEV

**Need Number:** DOM-2023-0032

**Process Stage:**

Submission of Supplemental Project for Inclusion in the Local Plan – 02/21/2024

**Selected Solution:**

Install a 1200 Amp, 50kAIC circuit switcher and associated equipment (bus, switches, relaying, etc.) to feed the new transformer at Cumulus.

**Estimated Cost:** \$0.5 M

**Projected In-Service:** 06/01/2025

**Supplemental Project ID:** s3054

**Project Status:** Engineering

**Model:** 2027 RTEP

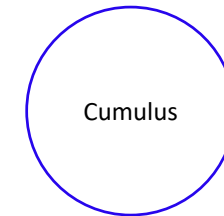

# Dominion Transmission Zone M-3 Process Metcalf 115kV Delivery – TX Upgrade - DEV

**Need Number:** DOM-2023-0036

**Process Stage:**

Submission of Supplemental Project for Inclusion in the Local Plan – 02/21/2024

**Previously Presented:**

Need – 07/20/2023

Solution – 08/17/2023

**Project Driver:**

Customer Service

**Specific Assumption Reference:**

Customer load request will be evaluated per Dominion’s Facility Interconnection Requirements Document and Dominion’s Transmission Planning Criteria.

**Problem Statement:**

DEV Distribution has submitted a delivery point (DP) request to upgrade TX #1 at Metcalf Substation in Greensville County, VA. The new transformer is needed because the existing one is 52 years old and has a low THA rating. Requested in-service date is 12/31/2024.

**Projected 2028 Load**

**Summer:** 8.0 MW

**Winter:** 10.3 MW

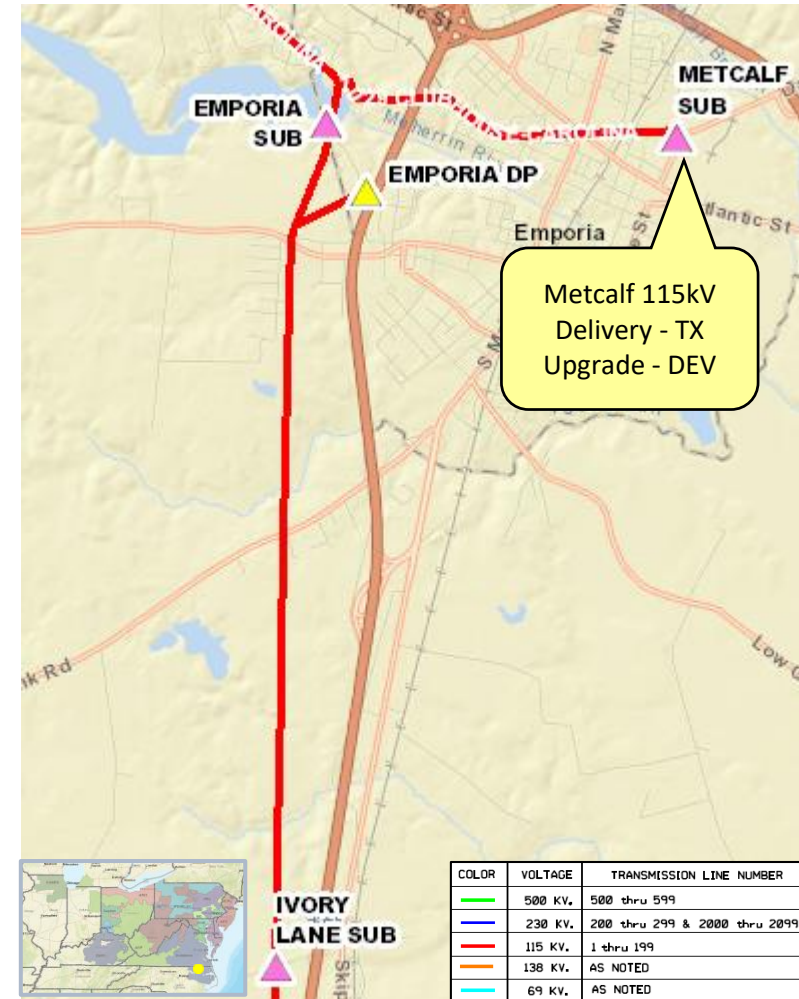

# Dominion Transmission Zone M-3 Process Metcalf 115kV Delivery – TX Upgrade - DEV

**Need Number:** DOM-2023-0036

**Process Stage:**

Submission of Supplemental Project for Inclusion in the Local Plan – 02/21/2024

**Selected Solution:**

Replace the fuse on the high side with a 1200A, 25kAIC circuit switcher, install any high side equipment to accommodate the installation of the new transformer.

**Estimated Cost:** \$0.62 M

**Projected In-Service:** 12/31/2024

**Supplemental Project ID:** s3057

**Project Status:** Engineering

**Model:** 2027 RTEP

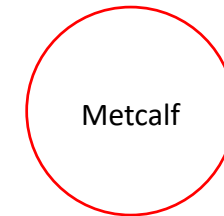

# Dominion Transmission Zone M-3 Process Bishop Sub – 115kV Delivery – MEC

**Need Number:** DOM-2023-0041

**Process Stage:**

Submission of Supplemental Project for Inclusion in the Local Plan – 02/21/2024

**Previously Presented:**

Need – 07/20/2023

Solution – 08/17/2023

**Project Driver:**

Customer Service

**Specific Assumption Reference:**

Customer load request will be evaluated per Dominion’s Facility Interconnection Requirements Document and Dominion’s Transmission Planning Criteria.

**Problem Statement:**

ODEC on behalf of Mecklenburg Electric Coop (MEC) has submitted a delivery point (DP) request to serve a Data Center load at Mecklenburg County, VA. Final load is 48 MW, and the requested service date is 01/01/2025.

**Projected 2028 Load**

**Summer:** 48.0 MW

**Winter:** 48.0 MW

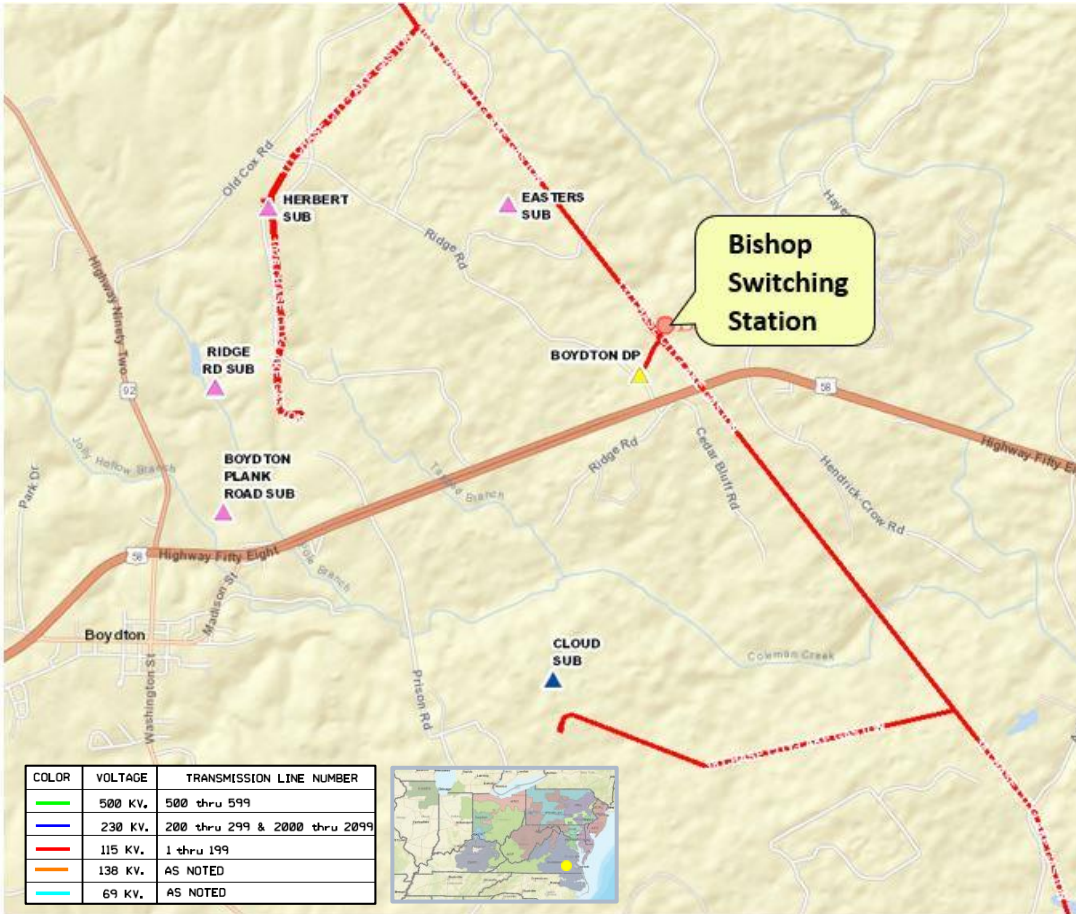

# Dominion Transmission Zone M-3 Process

## Bishop Sub – 115kV Delivery – MEC

**Need Number:** DOM-2023-0041

**Process Stage:**

Submission of Supplemental Project for Inclusion in the Local Plan – 02/21/2024

**Selected Solution:**

Construct a new substation by cutting and extending Line #137 (Kerr Dam – Ridge Road) to the proposed Bishop 115kV Substation. The final build-out includes 6-breaker ring bus and two 115 kV feeds to the customer. Customer will be responsible for paying for any excess transmission or substation equipment above a tap-line.

<b>Estimated Cost:</b>	\$15.0 M (Total)
Transmission Line	\$2.5M
115kV Substation	\$12.5M

**Projected In-Service:** 01/01/2025

**Supplemental Project ID:** s3081

**Project Status:** Engineering

**Model:** 2027 RTEP

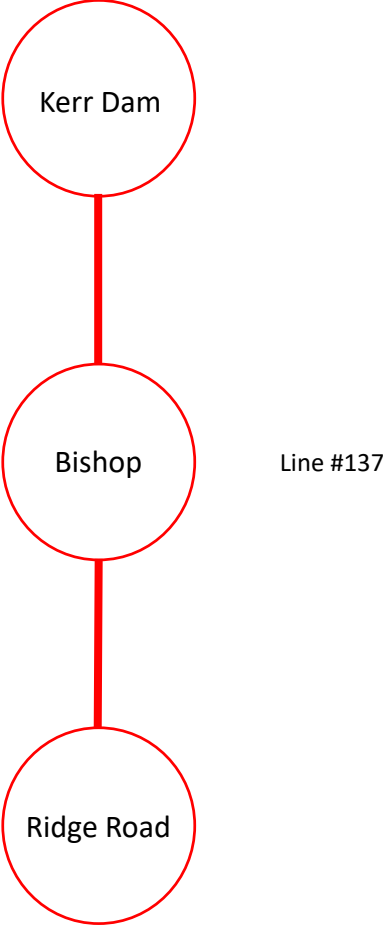

# Dominion Transmission Zone M-3 Process Magruder Substation – Upgrade TX#1

**Need Number:** DOM-2023-0037

**Process Stage:**

Submission of Supplemental Project for Inclusion in the Local Plan – 03/25/2024

**Previously Presented:**

Need – 06/15/2023

Solution – 11/16/2023

**Project Driver:**

Customer Service

**Specific Assumption Reference:**

Customer load request will be evaluated per Dominion’s Facility Interconnection Requirements Document and Dominion’s Transmission Planning Criteria.

**Problem Statement:**

DEV has submitted a delivery point request to upgrade transformer #1 existing Magruder Substation in Hampton, VA. The upgrade is being driven by new customer load. The total load is under 100 MW. The customer requests service by December 31, 2024.

**Projected 2028 Load**

**Summer:** 64.1 MW

**Winter:** 58.6 MW

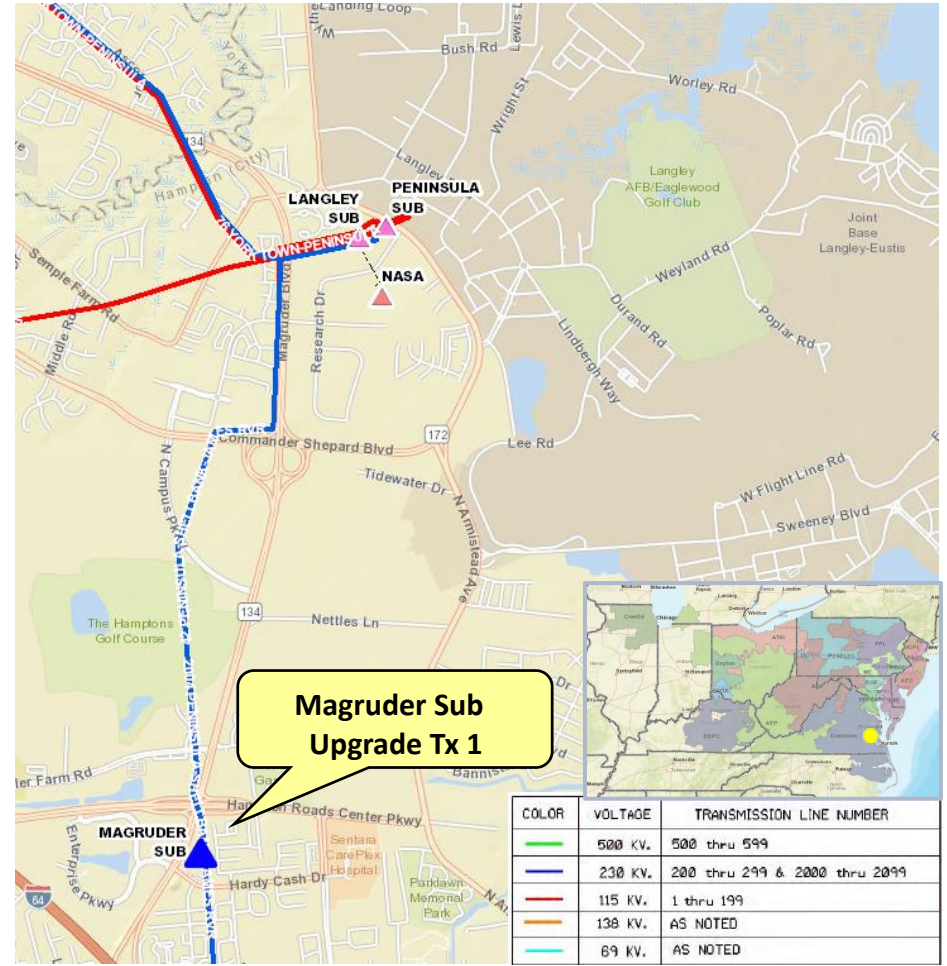

# Dominion Transmission Zone M-3 Process Magruder Substation – Upgrade TX#1

**Need Number:** DOM-2023-0037

**Process Stage:**

Submission of Supplemental Project for Inclusion in the Local Plan – 03/25/2024

**Selected Solution:**

Install a 115kV circuit switcher, high side switch and any associated transmission equipment and bus work needed to facilitate the transformer installation.

**Estimated Cost:** \$0.764 M

**Projected In-Service:** 12/31/2024

**Supplemental Project ID:** s3220.1

**Project Status:** Conceptual

**Model:** 2027 RTEP





# Dominion Transmission Zone M-3 Process Northwoods 230kV Delivery - NOVEC

**Need Number:** DOM-2023-0039

**Process Stage:**

Submission of Supplemental Project for Inclusion in the Local Plan – 03/25/2024

**Previously Presented:**

Need – 07/11/2023

Solution – 09/05/2023

**Project Driver:**

Customer Service

**Specific Assumption Reference:**

Customer load request will be evaluated per Dominion’s Facility Interconnection Requirements Document and Dominion’s Transmission Planning Criteria.

**Problem Statement:**

NOVEC has submitted a DP Request for a new substation (Northwoods) in Loudoun County with a total load in excess of 100MW. Requested in-service date is 04/01/2026.

**Projected 2028 Load**

**Summer:** 185.0 MW

**Winter:** 200.0 MW

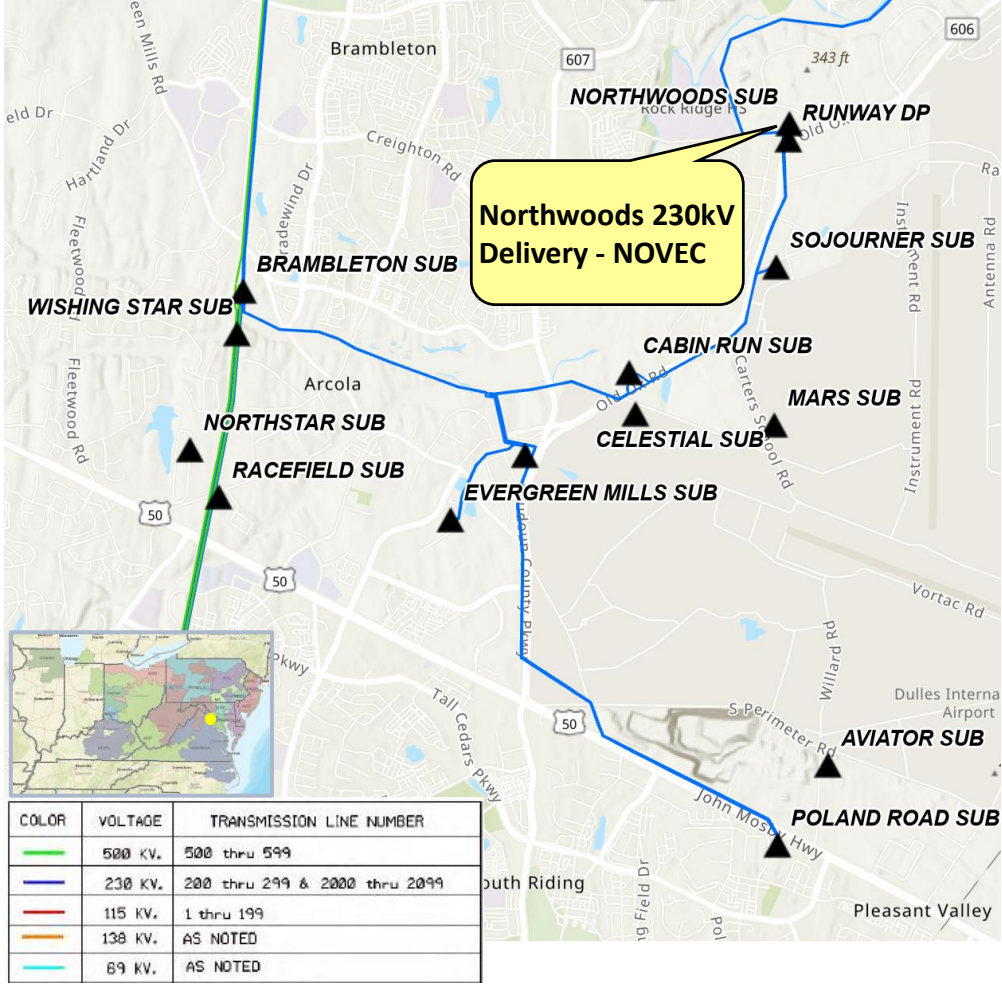

# Dominion Transmission Zone M-3 Process Northwoods 230kV Delivery - NOVEC

**Need Number:** DOM-2023-0039

**Process Stage:**

Submission of Supplemental Project for Inclusion in the Local Plan – 03/25/2024

**Selected Solution:**

Interconnect the new substation by cutting and extending Line #2218 (Sojourner – Shellhorn) to the proposed Northwoods Substation. Lines to terminate in a 230kV four-breaker ring arrangement with an ultimate arrangement of a six-breaker ring.

**Estimated Cost:** \$20.0 M

**Projected In-Service:** 04/01/2026

**Supplemental Project ID:** s3218.1

**Project Status:** Engineering

**Model:** 2027 RTEP

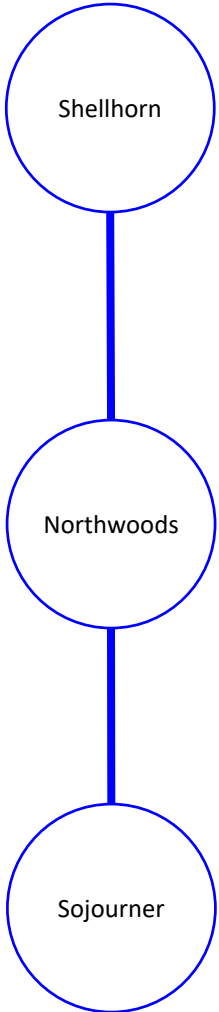

# Dominion Transmission Zone M-3 Process

## 230kV Line 246 – EOL Rebuild

**Need Number:** DOM-2023-0044

**Process Stage:**

Submission of Supplemental Project for Inclusion in the Local Plan – 03/25/2024

**Previously Presented:**

Need – 12/05/2023

Solution – 08/08/2023

**Project Driver:**

Equipment Material Condition, Performance Risk

**Specific Assumption Reference:**

See details on Equipment Material Condition, Performance and Risk in Dominion’s Planning Assumptions presented in December 2022.

**Problem Statement:**

Dominion Energy has identified a need to replace approximately 44.3 miles of 230kV Line #246 (Suffolk to Earleys) to new 230kV standards based on the Company’s End of Life criteria.

- Line #246 was constructed on primarily wood H-frame structures in 1971, with many in need of replacement due to deterioration.
- Industry guidelines indicate equipment life for steel structures is 40-60 years, wood structures is 35-55 years, conductor and connectors are 40-60 years, and porcelain insulators are 50 years.
- Line #246 provides service to Nucor substation with approximately 36.7MW of load.

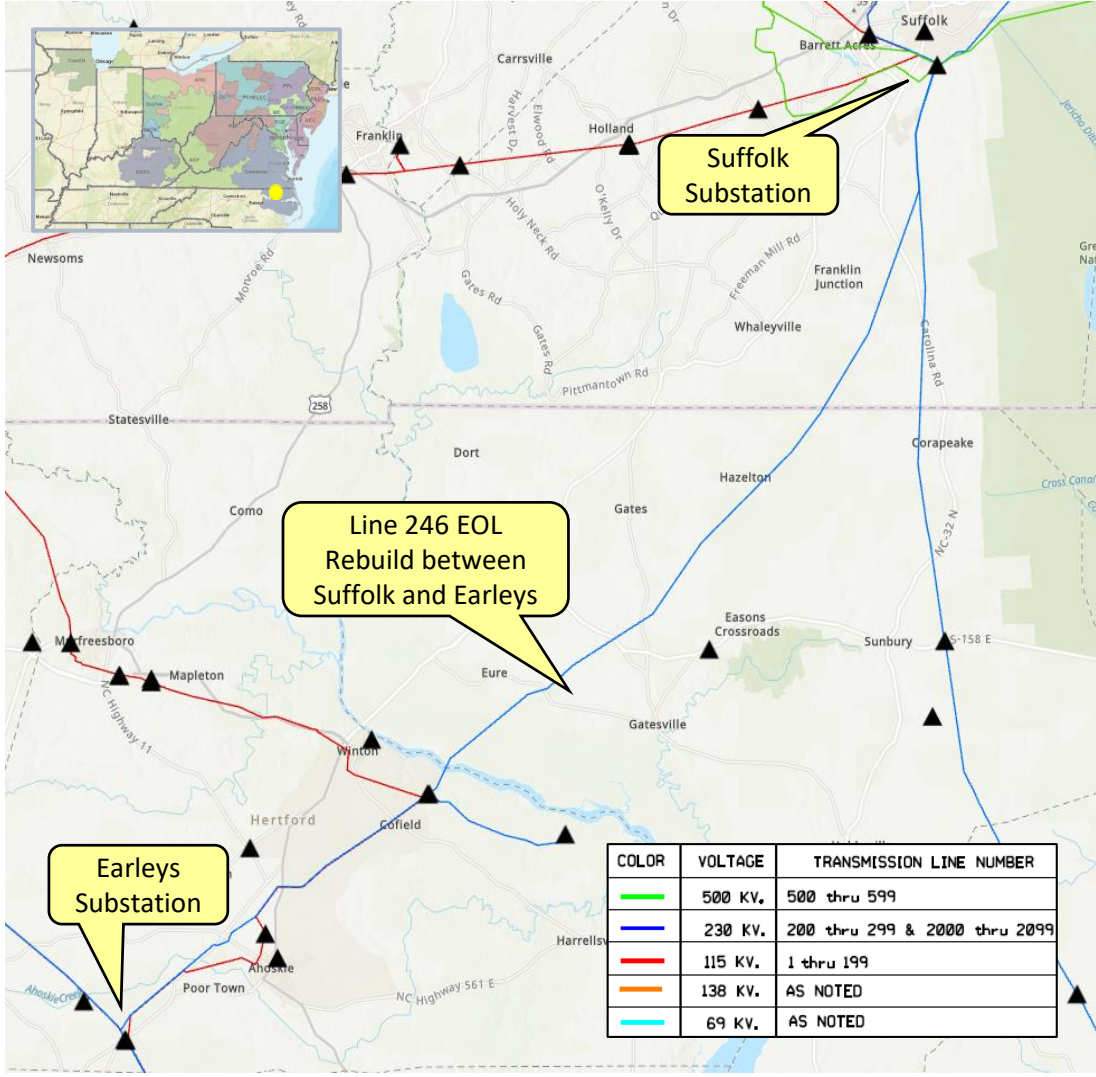

# Dominion Transmission Zone M-3 Process

## 230kV Line 246 – EOL Rebuild

**Need Number:** DOM-2023-0044

**Process Stage:**

Submission of Supplemental Project for Inclusion in the Local Plan – 03/25/2024

**Selected Solution:**

Rebuild approximately 44.3 miles of Line 246 between Earleys and Suffolk to current 230kV standards. The normal rating of the line conductor will be 1573 MVA.

**Estimated Cost:** \$150.0 M

**Projected In-Service:** 12/31/2028

**Supplemental Project ID:** s3222.1

**Project Status:** Conceptual

**Model:** 2027 RTEP

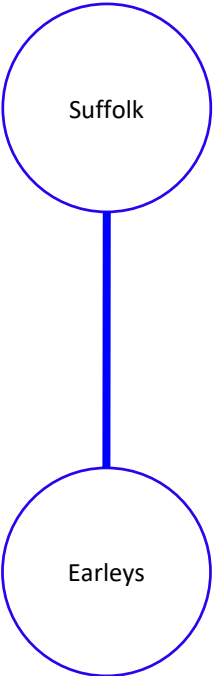

# Dominion Transmission Zone M-3 Process

## Wishing Star DP 230kV Delivery- NOVEC

**Need Number:** DOM-2023-0045

**Process Stage:**

Submission of Supplemental Project for Inclusion in the Local Plan – 03/25/2024

**Previously Presented:**

Need – 08/08/2023

Solution – 09/05/2023

**Project Driver:**

Customer Service

**Specific Assumption Reference:**

Customer load request will be evaluated per Dominion’s Facility Interconnection Requirements Document and Dominion’s Transmission Planning Criteria.

**Problem Statement:**

NOVEC has submitted a DP Request for a new substation (Wishing Star DP) in Loudoun County with a total load in excess of 100MW. Requested in-service date is 12/01/2026.

**Projected 2028 Load**

**Summer:** 57.0 MW

**Winter:** 30.0 MW

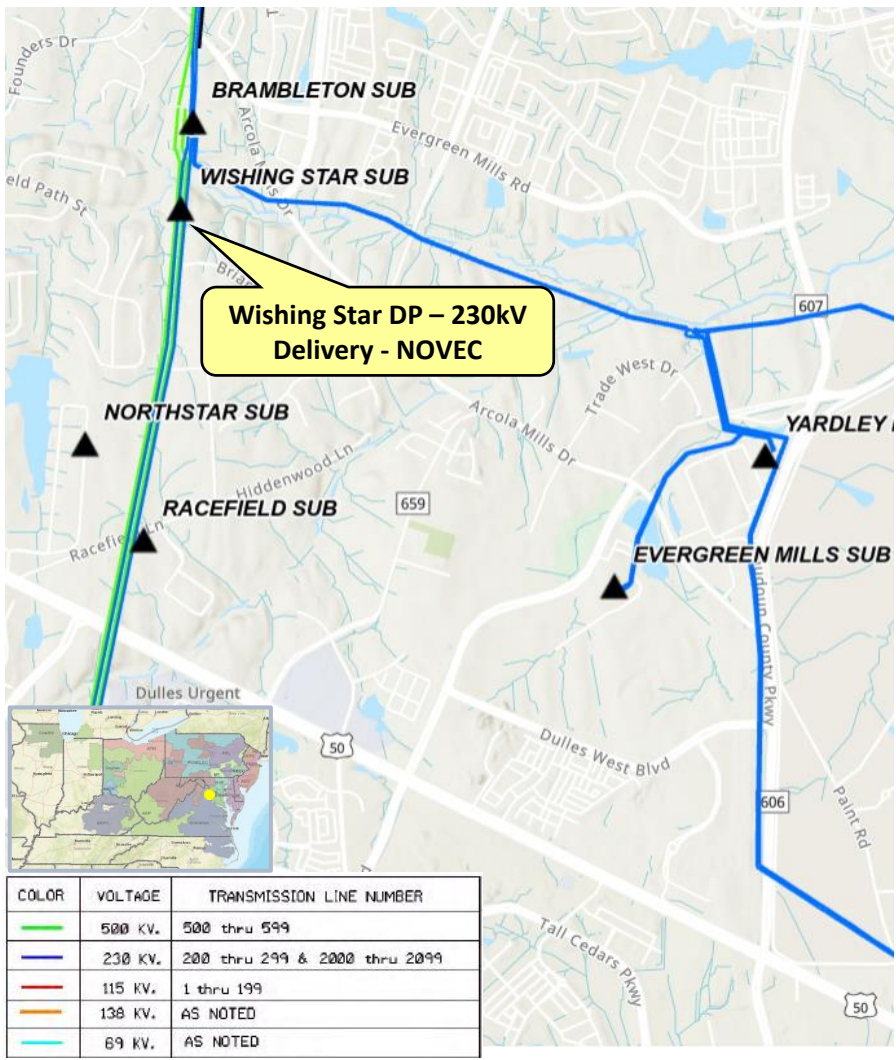

# Dominion Transmission Zone M-3 Process

## Wishing Star DP 230kV Delivery- NOVEC

**Need Number:** DOM-2023-0045

**Process Stage:**

Submission of Supplemental Project for Inclusion in the Local Plan – 03/25/2024

**Selected Solution:**

Provide two 230kV feeds from Dominion’s proposed Wishing Star 500/230kV Sub to NOVEC’s Wishing Star DP.

**Estimated Cost:** \$1.5 M

**Projected In-Service:** 12/01/2026

**Supplemental Project ID:** s3219.1

**Project Status:** Engineering

**Model:** 2027 RTEP



# Dominion Transmission Zone M-3 Process Princess Anne Substation – Upgrade TX#1

**Need Number:** DOM-2023-0047

**Process Stage:**

Submission of Supplemental Project for Inclusion in the Local Plan – 03/25/2024

**Previously Presented:**

Need – 08/17/2023

Solution – 11/16/2023

**Project Driver:**

Customer Service

**Specific Assumption Reference:**

Customer load request will be evaluated per Dominion’s Facility Interconnection Requirements Document and Dominion’s Transmission Planning Criteria.

**Problem Statement:**

DEV has submitted a delivery point request to upgrade transformer 1 at Princess Anne Substation in Virginia Beach, VA. The upgrade is being driven by new customer load. The total load is under 100 MW. The customer requests service by December 30, 2024.

**Projected 2028 Load**

**Summer:** 31.8 MW

**Winter:** 23.7 MW

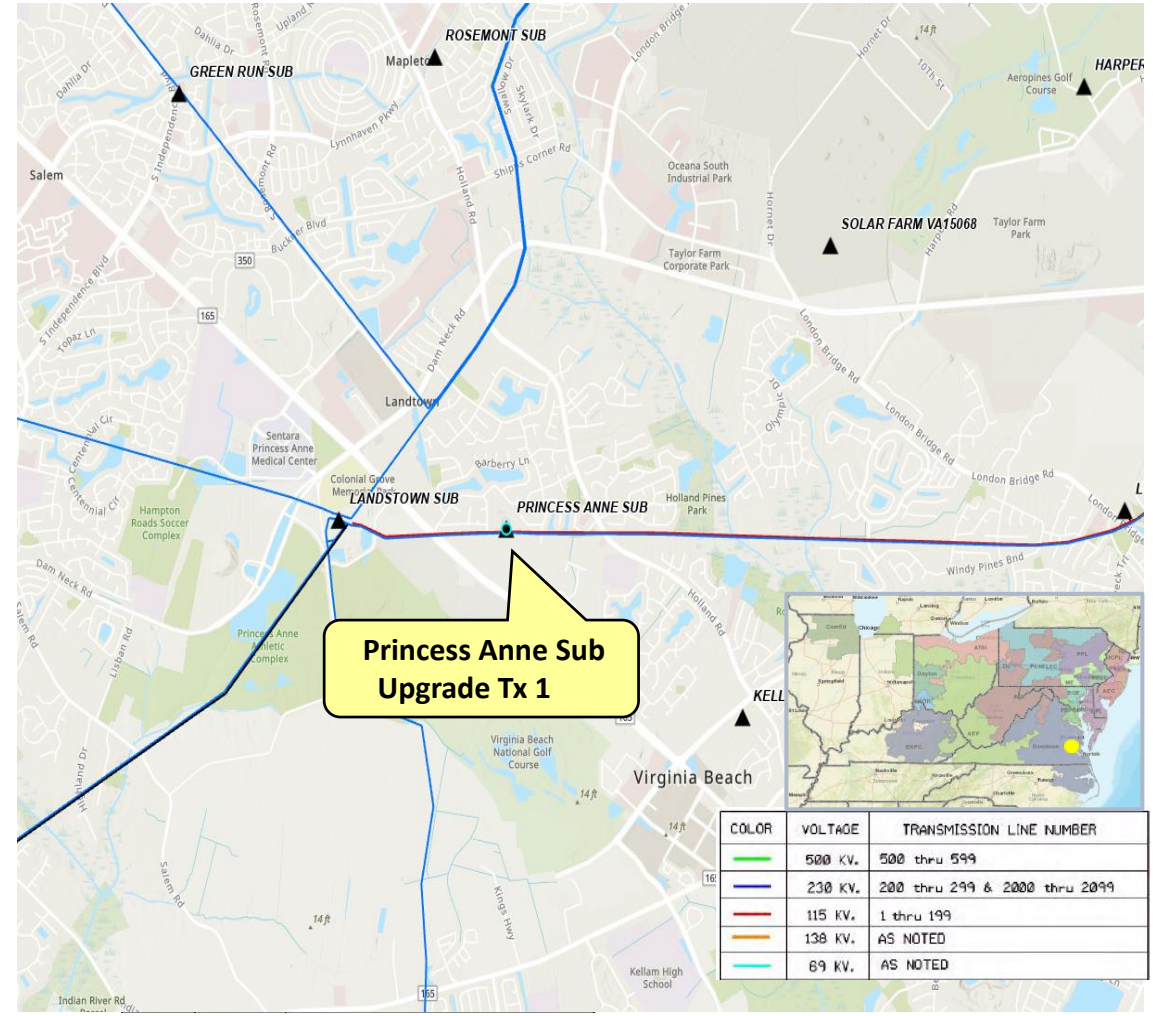

# Dominion Transmission Zone M-3 Process Princess Anne Substation – Upgrade TX#1

**Need Number:** DOM-2023-0047

**Process Stage:**

Submission of Supplemental Project for Inclusion in the Local Plan – 03/25/2024

**Selected Solution:**

Install a 115kV circuit switcher, high side switch, wave trap and any associated transmission equipment and bus work needed for transformer upgrade.

**Estimated Cost:** \$0.5 M

**Projected In-Service:** 12/30/2024

**Supplemental Project ID:** s3221.1

**Project Status:** Conceptual

**Model:** 2027 RTEP





# Revision History

02/21/2024 – V1 – Local Plan posted to pjm.com for s2340.1, s2340.2, s2499, s2500, s2609.2, s2620, s2825.1, s2825.2, s3018 – s3081 excluding s3043 & s3073.

03/26/2024 – V2 – Local Plan posted to pjm.com for s3218.1-s3222.1.