

# Submission of PPL Supplemental Projects for Inclusion in the 2024 Local Plan

# PPL Transmission Zone: Supplemental

**Need Number: PPL-2019-0007**

**Process Stage:** Submission of Supplemental Project for inclusion in the Local Plan 2/27/2024

**Need Presented: 09/14/2023**

**Solution Presented: 10/19/2023**

**Supplemental Project Driver:** Equipment Material Condition, Performance and Risk;

**Problem Statement:**

The Lycoming – Williamsport #1 & #2 69kV lines are a reliability risk due to poor asset health. The lines are in poor condition with the original assets being installed in 1930. These are two single circuit lines at 1.75 and 2.1 miles, respectively. The lines have the original 2/0 and 4/0 Cu conductor and are primarily wood poles with steel poles interspersed. On the lines, 62 of the 88 poles are wood with the remainder steel. There have 3 outages on this line since 2015:

Cause	Momentary	Permanent	Total
Foreign Interference (Other utility)	1	0	1
Lightning	2	0	2
<b>Grand Total</b>	<b>3</b>	<b>0</b>	<b>3</b>

**Specific Assumption References:**

[PPL 2023 Annual Assumptions](#)

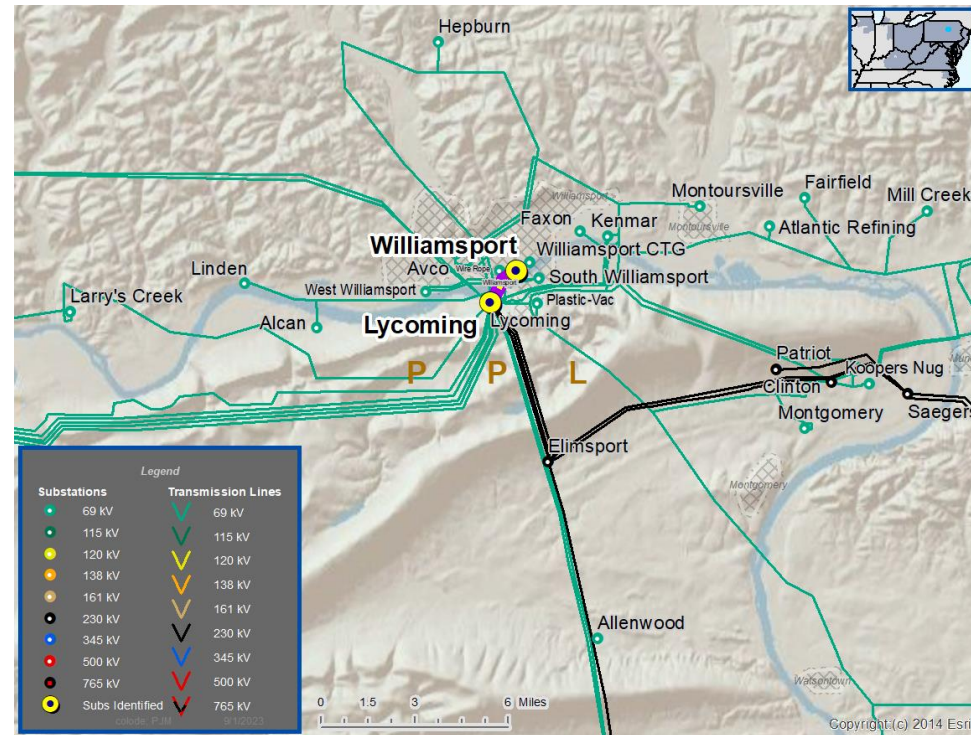

**Need Number: PPL-2019-0007**

**Process Stage:** Submission of Supplemental Project for inclusion in the Local Plan 2/27/2024

**Proposed Solution:**

Rebuild the Lycoming – Williamsport #2 69kV line (2.1 miles) to double circuit 69kV operation with 556 ACSR conductor. Remove 1.2 miles of the Lycoming – Williamsport #1 69kV line.

**Alternatives Considered:**

1. Removing the lines was not feasible due to distribution substations being served from the lines.
2. Keeping the lines as two single circuits was determined to be less cost effective. This arrangement was estimated at \$7.5M

**Estimated Project Cost:** \$6M

**Projected In-Service:** 12/30/2027

**Project Status:** Conceptual

**Model:** 2027

**Supplemental #:** s3085.1

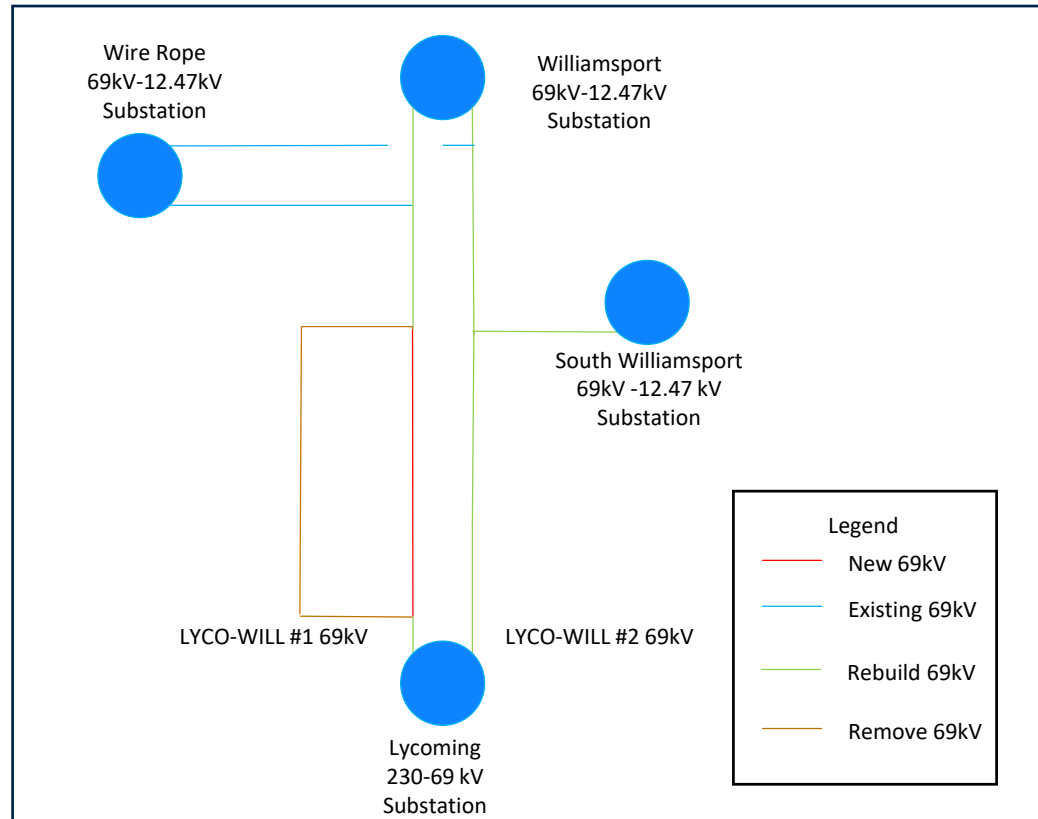

# PPL Transmission Zone: Supplemental

**Need Number: PPL-2023-0005**

**Process Stage:** Submission of Supplemental Project for inclusion in the Local Plan 2/27/2024

**Need Slide Presented:** 03/16/2023

**Solution Presented:** 07/20/2023

**Supplemental Project Driver:** Customer Service

## Problem Statement:

- PPL Distribution has submitted a request for double circuit 69kV service for a new 69-12kV substation near Hazelton, PA. There have been multiple requests for distribution service from new customers with a total expected load addition of 40-45 MWs. The distribution system in the area does not have sufficient capacity to serve the load.

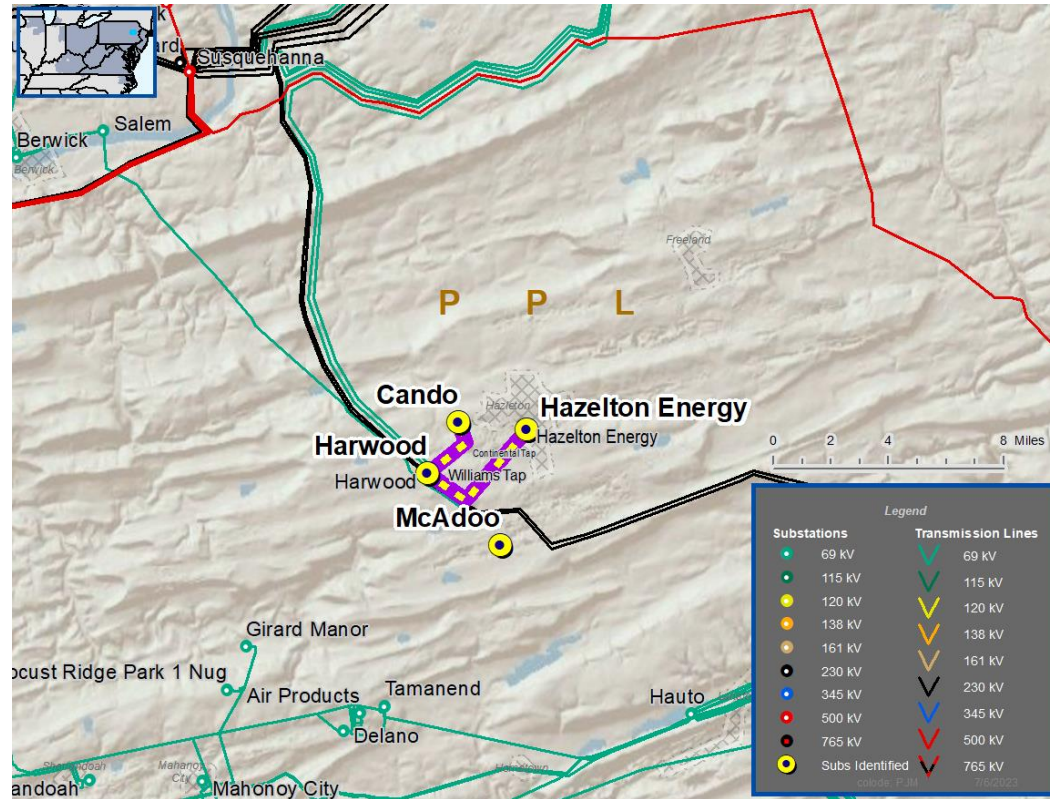

## Specific Assumption References:

[PPL 2023 Annual Assumptions](#)

**Need Number: PPL-2023-0005**

**Process Stage:** Submission of Supplemental Project for inclusion in the Local Plan 2/27/2024

**Proposed Solution:**

- Extend a new double circuit 69kV tap from the existing Harwood – East Hazelton 1 & 2 69kV lines line to interconnect a PPL Distribution owned 69-12.47kV substation (McAdoo).
- Add a second circuit from Harwood substation to Cando tap (1.3 miles), reconfigure existing circuits from Cando and Harleigh, and install 3.6 miles of new double circuit 69kV from Harleigh to East Hazelton.

**Alternatives Considered:**

Installing a new 230/69kV substation close to McAdoo but would cost greater than \$40 million.

**Estimated Project Cost:** \$15M

**Projected In-Service:** 12/1/2027

**Project Status:** Conceptual

**Model:** 2027

**Supplemental #:** s3082.1

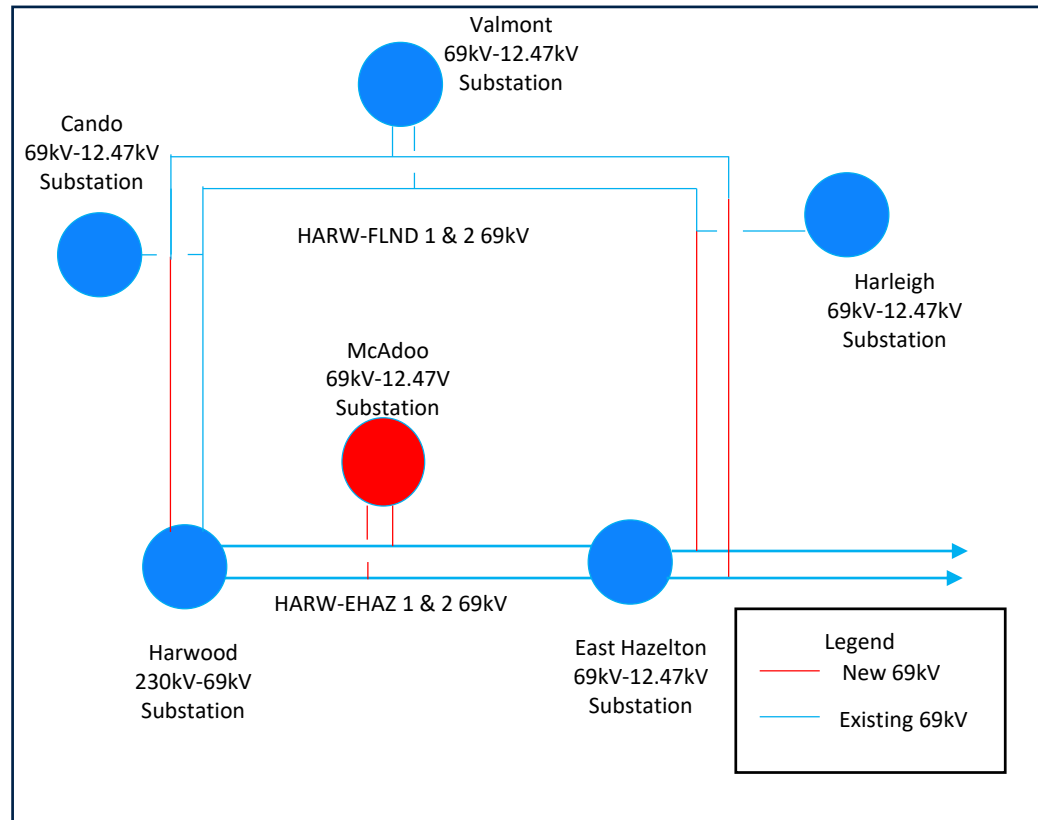



# PPL Transmission Zone: Supplemental

**Need Number: PPL-2023-0007**

**Process Stage:** Submission of Supplemental Project for inclusion in the Local Plan 2/27/2024

**Need Slide Presented:** 09/14/2023

**Solution Presented:** 10/19/2023

**Supplemental Project Driver:** Equipment Material Condition, Performance, and Risk.

Operational Flexibility and Efficiency.

## Problem Statement:

The Sunbury-Lock Haven 69kV line is a reliability risk due to poor asset health. The line is in poor condition with the original assets installed in 1949. The line consists of 420 wood poles, 10 towers, and 349 steel poles. The 556 ACSR conductor was installed in 1971. The line has experienced 11 operations since 2017. Transfer capability is limited in the Lock Haven area due to the long line lengths (~40 miles) and the network operation. There is customer outage exposure when taking line sections out for maintenance.

Cause	Momentary	Permanent	Total
Foreign Interference (Animal)	2	0	2
Lightning	4	0	4
Vegetation	1	2	3
Failed AC Substation Equipment	1	0	1
Foreign Interference – Machinery	1	0	1
<b>Grand Total</b>	<b>9</b>	<b>2</b>	<b>11</b>

**Specific Assumption References:**

[PPL 2023 Annual Assumptions](#)

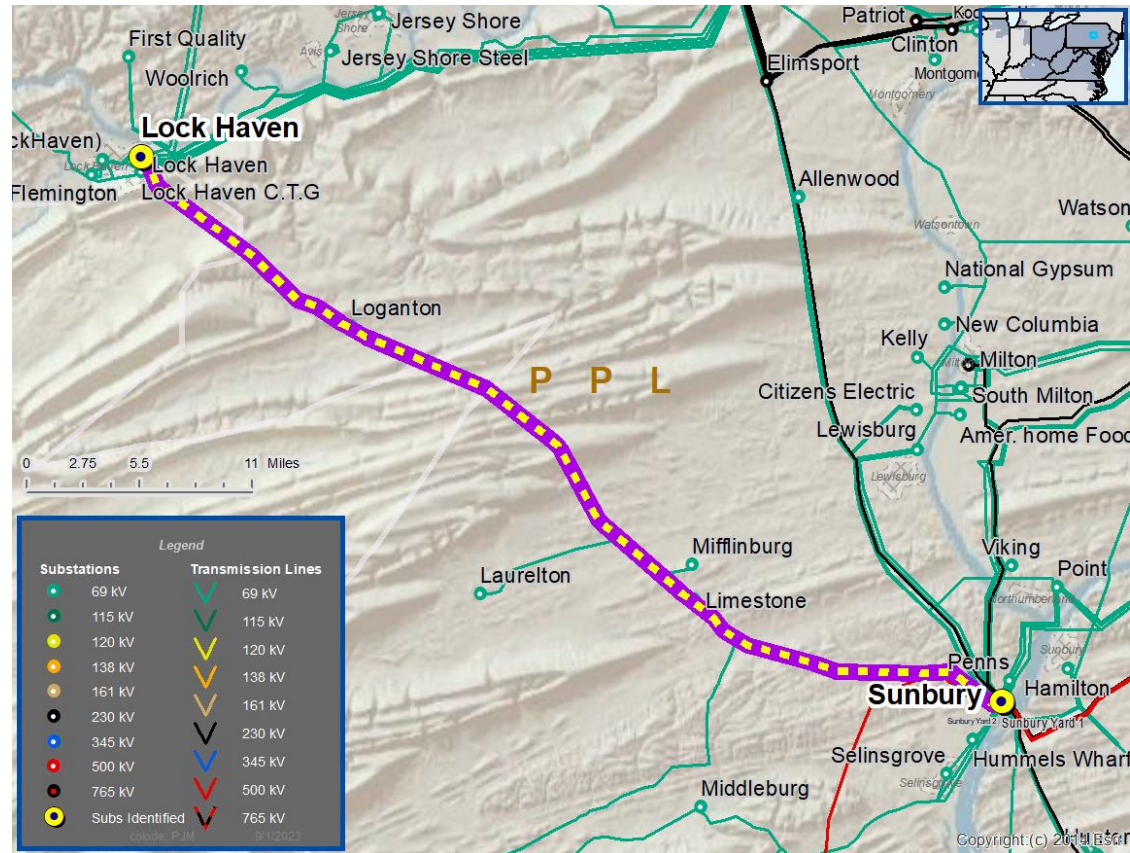

**Need Number: PPL-2023-0007**

**Process Stage:** Submission of Supplemental Project for inclusion in the Local Plan 2/27/2024

**Proposed Solution:**

Rebuild the Sunbury – Lock Haven 69kV line (~39 miles) to double circuit 69kV operation with 795 ACSR conductor. Install new line terminals at Sunbury and Lock Haven substations to accommodate the new circuit.

**Alternatives Considered:**

1. Single Circuit initial, future double circuit 69kV design. This was estimated at \$88 M and \$26.75 M to add the second circuit in the future.

**Estimated Project Cost:** \$103M

**Projected In-Service:** 12/30/2028

**Project Status:** Conceptual

**Model:** 2028

**Supplemental #:** s3083.1

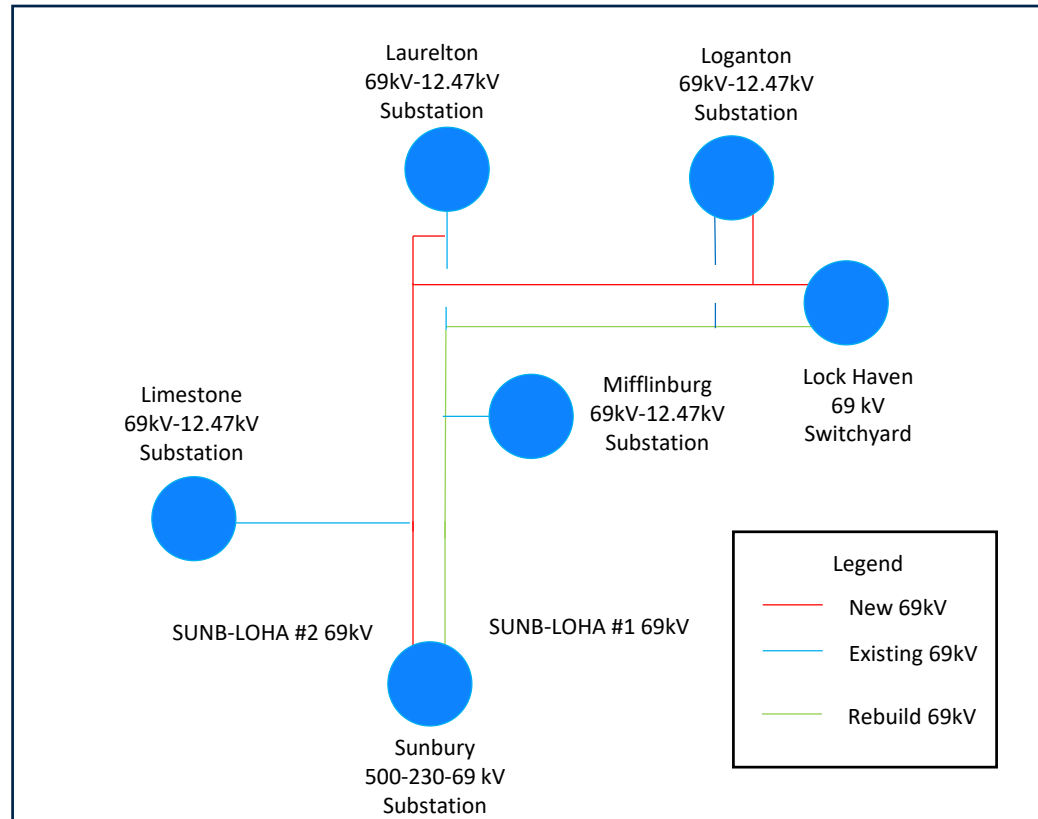

# PPL Transmission Zone: Supplemental

**Need Number: PPL-2023-0008**

**Process Stage:** Submission of Supplemental Project for inclusion in the Local Plan 2/27/2024

**Need Slide Presented: 07/20/2023**

**Solution Presented: 09/14/2023**

**Supplemental Project Driver:** Equipment Material Condition, Performance and Risk;

**Problem Statement:**

The Buxmont 2 - Upper Hanover Tap 69kV Line is a reliability risk due to poor asset health. The line is in poor condition with the original assets installed in 1951. This is a 9.14 mile tap line with the original 2/OF copperweld copper conductor and is primarily H-frame wood poles with steel poles interspersed. 101 of the 155 poles in the line section are wood with 56 remaining from the original install. Nine structures have recently failed inspection. Since 2015, there have been 3 momentary outages and 1 permanent outage.

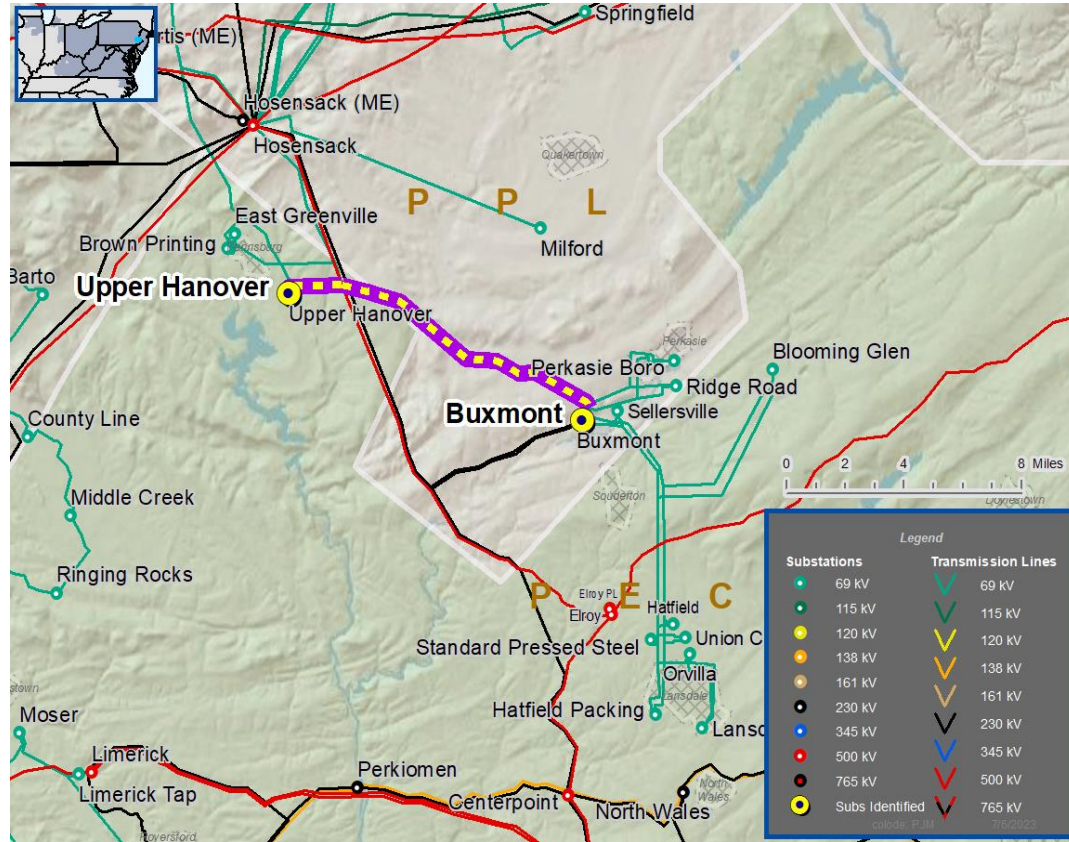

Cause	Momentary	Permanent	Total
Foreign Interference (Animal)	1	0	1
Lightning	1	0	1
Vegetation	1	0	1
Foreign Interference – Other Utility	0	1	1
Grand Total	3	1	4

**Specific Assumption References:**

[PPL 2023 Annual Assumptions](#)



# PPL Transmission Zone: Supplemental

**Need Number: PPL-2023-0008**

**Process Stage:** Submission of Supplemental Project for inclusion in the Local Plan 2/27/2024

**Proposed Solution:**

Rebuild the Buxmont 2 - Upper Hanover Tap 69kV line (~9.14 miles) to single circuit, future double circuit 69kV operation with 556 ACSR conductor.

**Alternatives Considered:**

1. Retirement of the line section would reduce operational flexibility and limit the ability to restore customers in the event of an outage.

**Estimated Project Cost:** \$18M

**Projected In-Service:** 5/31/2026

**Project Status:** Conceptual

**Model:** 2027

**Supplemental #:** s3084.1

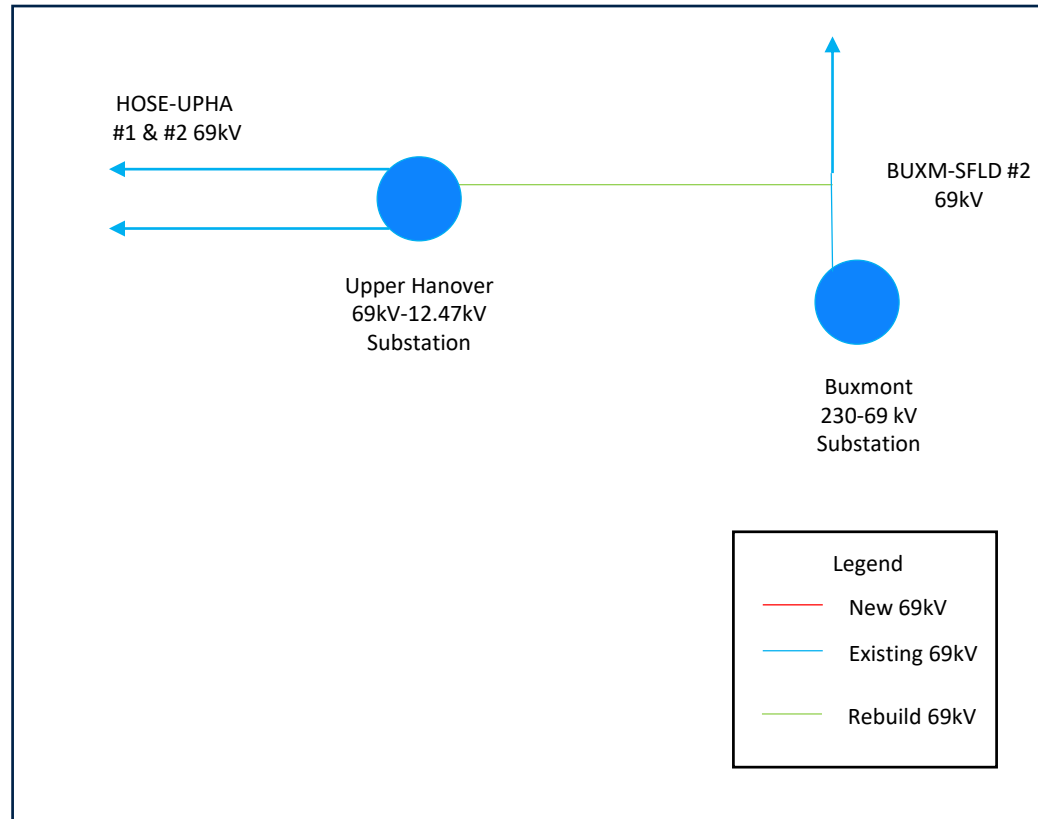

# PPL Transmission Zone: Supplemental

**Need Number: PPL-2023-0009**

**Process Stage:** Submission of Supplemental Project for inclusion in the Local Plan 2/27/2024

**Need Presented:** 09/14/2023

**Solution Presented:** 10/19/2023

**Supplemental Project Driver:** Customer Service

## Problem Statement:

PPL Distribution has submitted a request for a second 69kV feed at New Kingston Substation to feed a second 69-12kV transformer. There are several customers adding a combined load of 6.5 MW to New Kingston substation.

## Specific Assumption References:

[PPL 2023 Annual Assumptions](#)

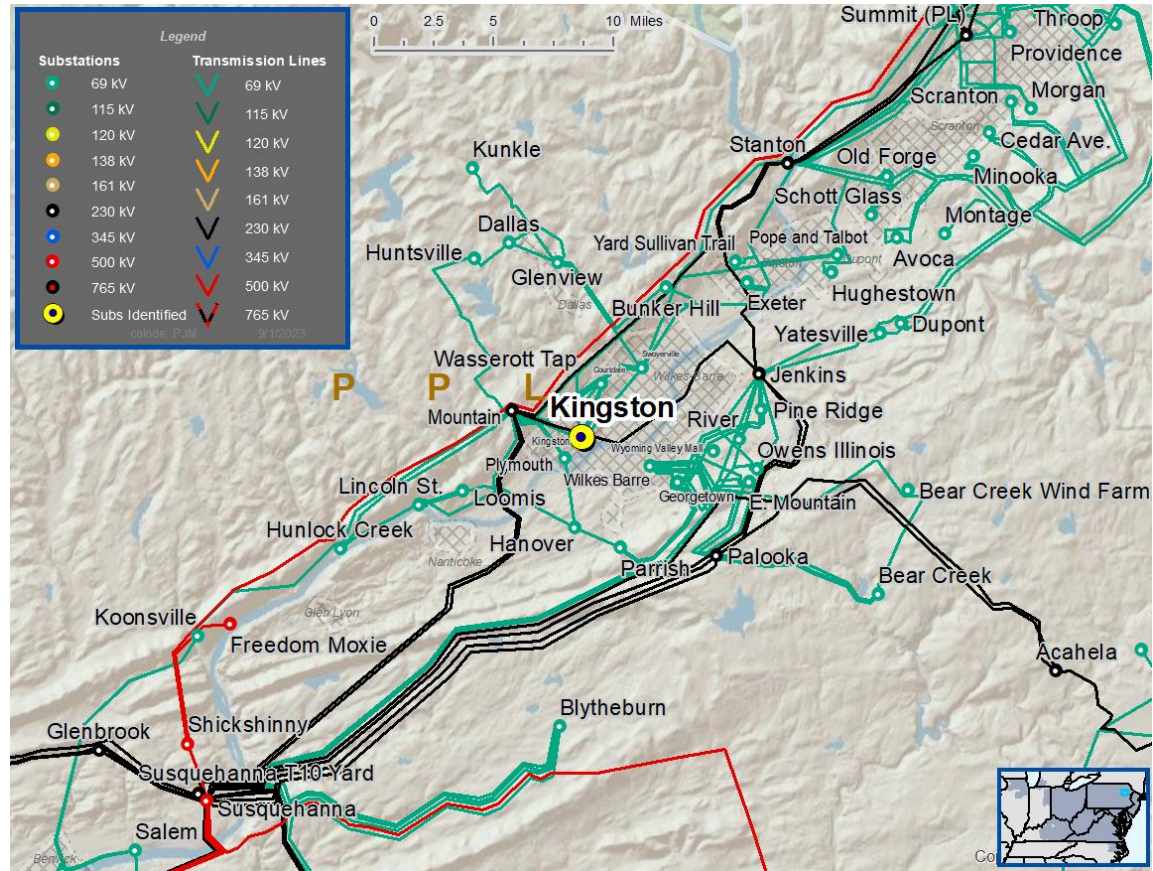

**Need Number: PPL-2023-0009**

**Process Stage:** Submission of Supplemental Project for inclusion in the Local Plan 2/27/2024

**Proposed Solution:**

Extend a second circuit to New Kingston substation from the Cumberland – Carlisle #2 69kV line (0.06 Miles)

**Alternatives Considered:**

1. Tapping the Cumberland – W. Carlisle #1 69kV line was considered but the CUMB-CARL #2 was closer to the substation.

**Estimated Project Cost:** \$0.9M

**Projected In-Service:** 11/30/2025

**Project Status:** Conceptual

**Model:** 2026

**Supplemental #:** s3086.1

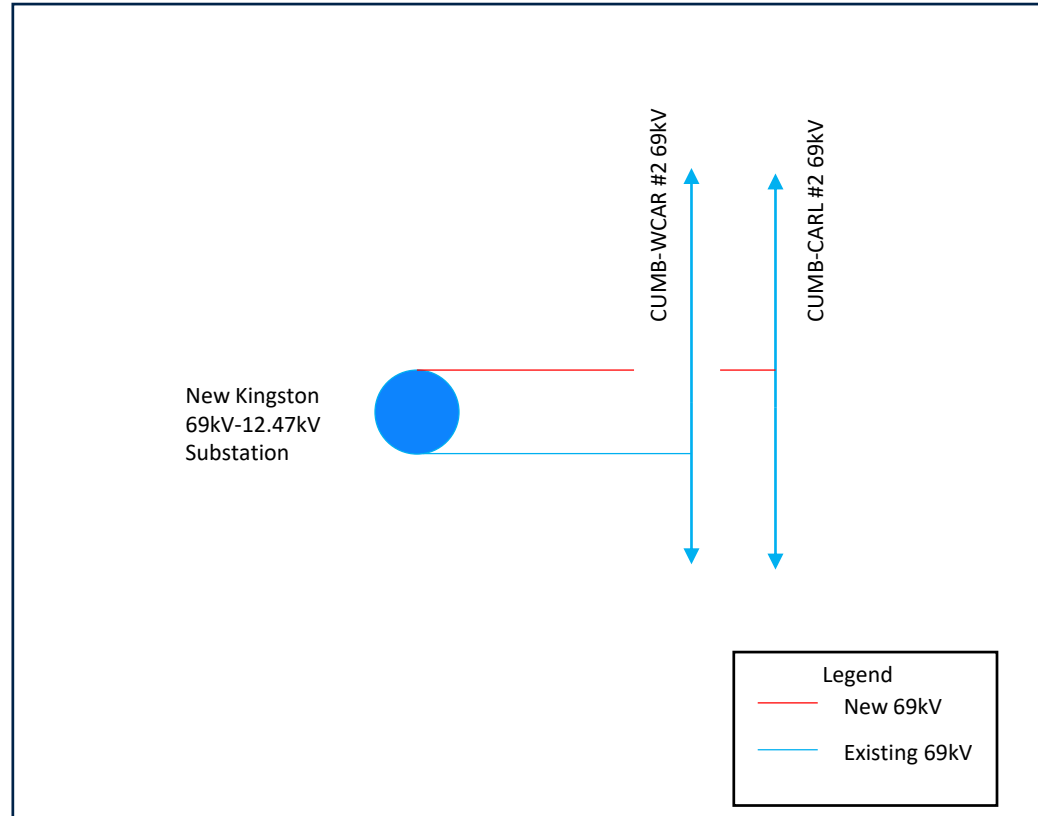

# PPL Transmission Zone: Supplemental

**Need Number: PPL-2023-0010**

**Process Stage:** Submission of Supplemental Project for inclusion in the Local Plan 2/27/2024

**Need Presented:** 09/14/2023

**Solution Presented:** 10/19/2023

**Supplemental Project Driver:** Equipment Material Condition, Performance and Risk;

**Problem Statement:**

The Hunlock-Glen Brook 69kV Line is a reliability risk due to poor asset health. The line is in poor condition with the original assets installed in 1929. The PPL section of this line is 4 miles long. The section to be rebuilt (3.5 miles) is the original 3/0 copper conductor and primarily wood poles with steel poles interspersed. In the section to be rebuilt, 90 of the 107 poles are wood with the remainder steel. There have been two outages on this section since 2015.

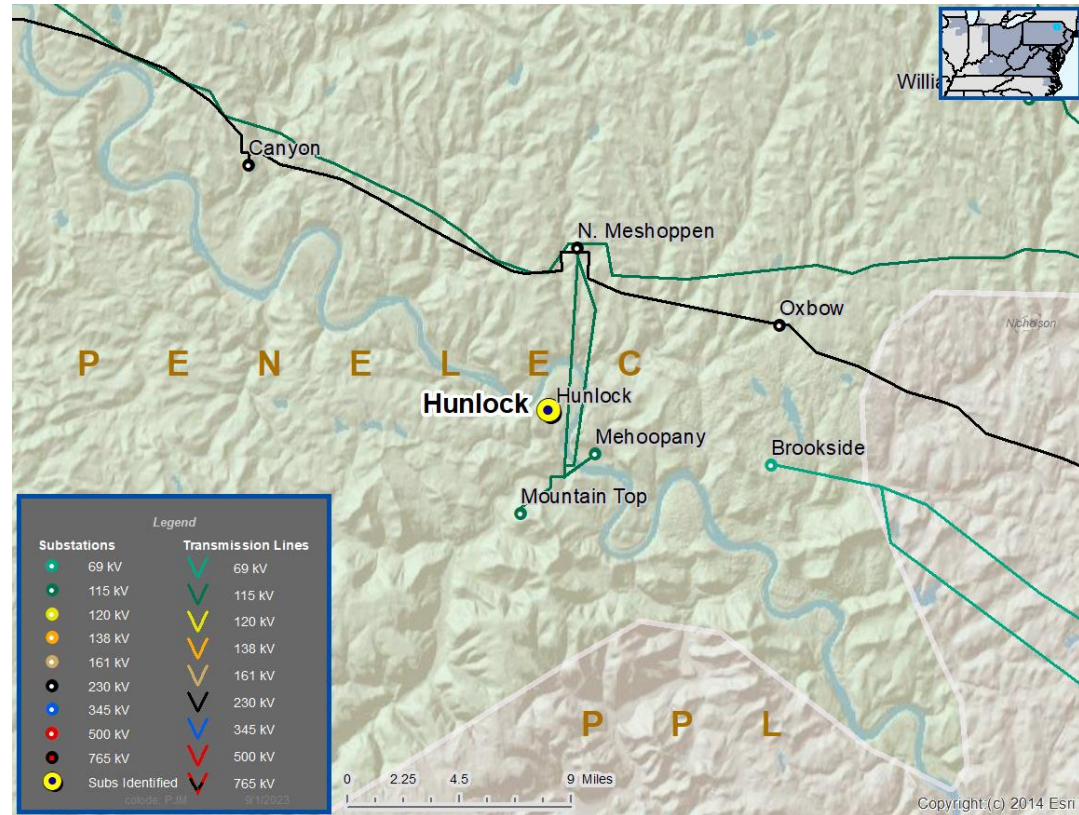

Cause	Momentary	Permanent	Total
Unknown	1	0	1
Vegetation	1	0	1
<b>Grand Total</b>	<b>2</b>	<b>0</b>	<b>2</b>

**Specific Assumption References:**

[PPL 2023 Annual Assumptions](#)



**Need Number: PPL-2023-0010**

**Process Stage:** Submission of Supplemental Project for inclusion in the Local Plan 2/27/2024

**Proposed Solution:**

Rebuild the PPL section of the Hunlock-Glen Brook 69kV line (3.5 miles) to single circuit 69kV operation with 556 ACSR conductor. **Alternatives Considered:**

1. Removing the line was not feasible due to loss of operational flexibility for serving a UGI distribution substation

**Estimated Project Cost:** \$7M

**Projected In-Service:** 12/30/2028

**Project Status:** Conceptual

**Model:** 2028

**Supplemental #:** s3087.1

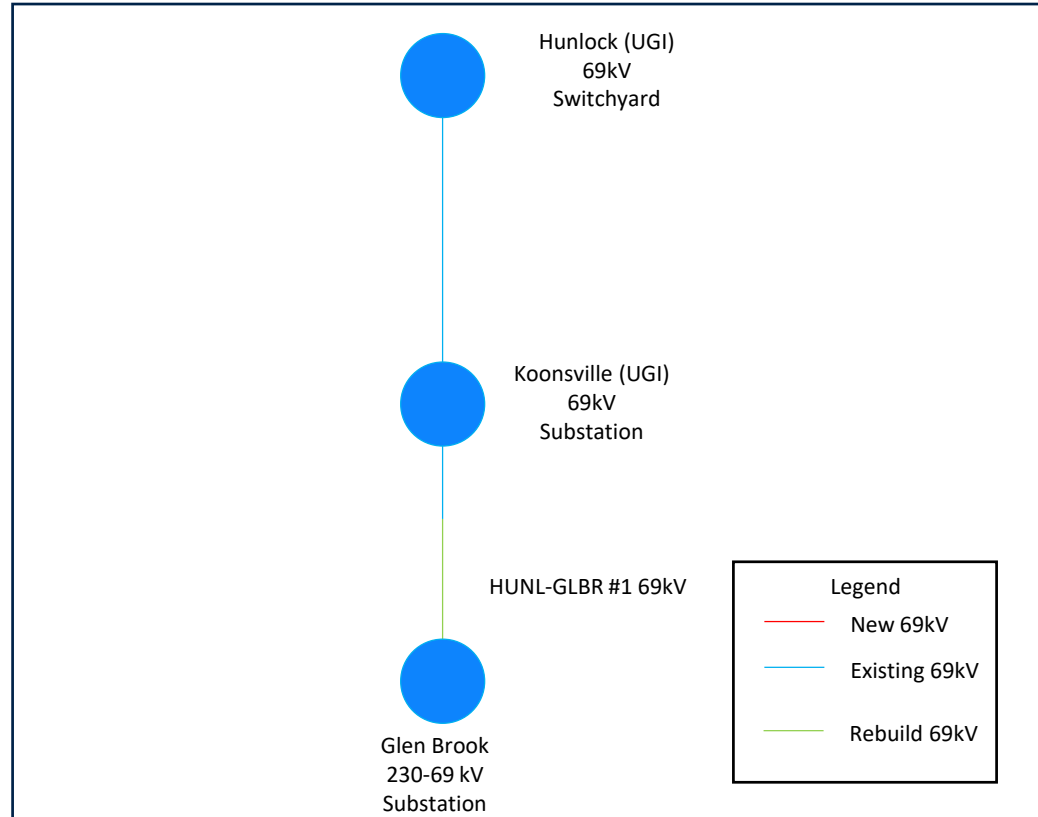

# PPL Transmission Zone: Supplemental

**Need Number: PPL-2023-0011**

**Process Stage:** Submission of Supplemental Project for inclusion in the Local Plan 2/27/2024

**Need Presented:** 09/14/2023

**Solution Presented:** 10/19/2023

**Supplemental Project Driver:** Equipment Material Condition, Performance and Risk;

## Problem Statement:

The Selinsgrove 69kV tap is a reliability risk due to poor asset health. The line is in poor condition with the original assets installed in 1968. This is a 1.45 mile tap with the original 556 ACSR conductor and primarily wood poles with steel poles interspersed. On the tap, 30 of the 46 poles are wood with the remainder steel. There has been one outage on this section since 2015.

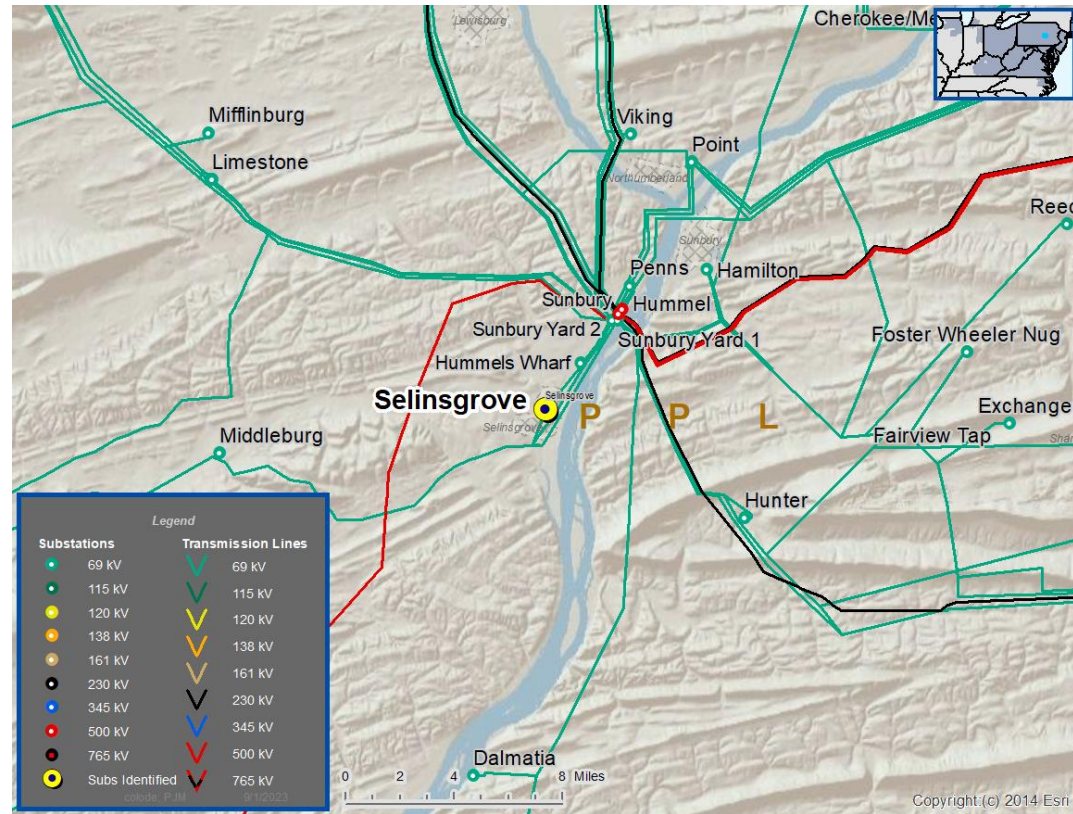

Cause	Momentary	Permanent	Total
Vegetation	0	1	1
<b>Grand Total</b>	0	1	1

## Specific Assumption References:

[PPL 2023 Annual Assumptions](#)

**Need Number: PPL-2023-0011**

**Process Stage:** Submission of Supplemental Project for inclusion in the Local Plan 2/27/2024

**Proposed Solution:**

Rebuild the Selinsgrove 69kV taps (1.45 miles) to double circuit 69kV operation with 556 ACSR conductor.

**Alternatives Considered:**

1. Removing the taps was not feasible due to a distribution substation being served by the lines.
2. Replacing the wood poles with steel poles was considered but clearance issues were discovered during project development.

**Estimated Project Cost:** \$3M

**Projected In-Service:** 12/30/2026

**Project Status:** Conceptual

**Model:** 2027

**Supplemental #:** s3088.1

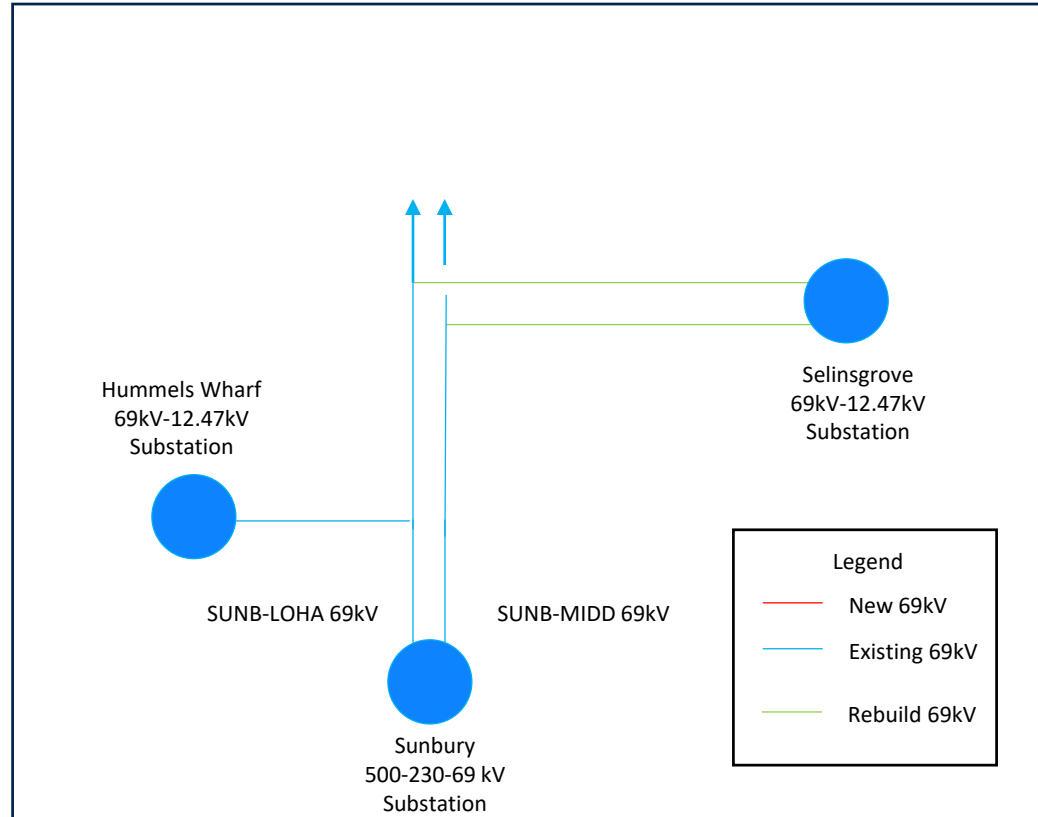

# PPL Transmission Zone: Supplemental

**Need Number: PPL-2023-0012**

**Process Stage:** Submission of Supplemental Project for inclusion in the Local Plan 2/27/2024

**Need Presented:** 09/14/2023

**Solution Presented:** 10/19/2023

**Supplemental Project Driver:** Customer Service

**Problem Statement:**

- A customer has submitted a request to have their facility served from a 69kV transmission line in Frailey, PA. The load is approximately 10 MVA.

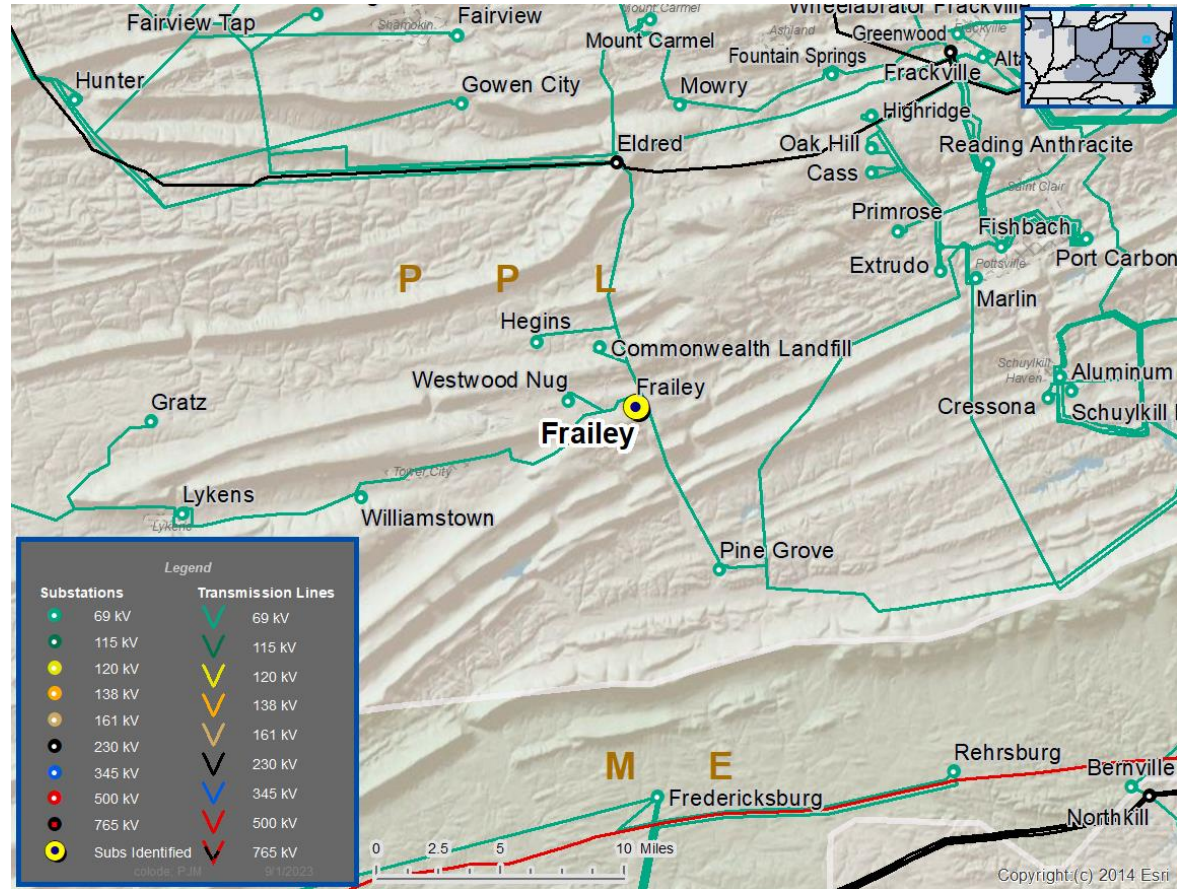

**Specific Assumption References:**  
[PPL 2023 Annual Assumptions](#)



**Need Number: PPL-2023-0012**

**Process Stage:** Submission of Supplemental Project for inclusion in the Local Plan 2/27/2024

**Proposed Solution:**

Extend a single circuit 69kV tap to the new customer substation from the Eldred – Pine Grove 69kV line (0.15 Miles)

**Alternatives Considered:**

1. No alternatives were considered as the Eldred – Pine Grove 69kV line is the only transmission line in the vicinity.

**Estimated Project Cost:** \$1.0M

**Projected In-Service:** 11/30/2025

**Project Status:** Conceptual

**Model:** 2026

**Supplemental #:** s3089.1

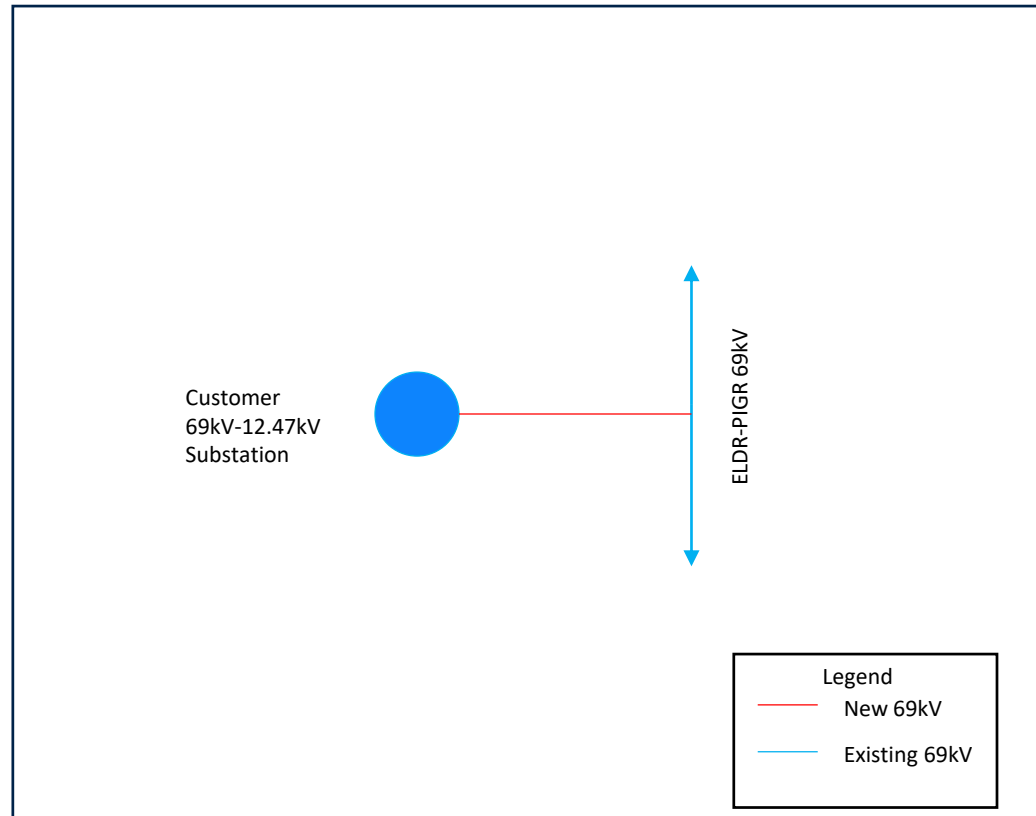

# PPL Transmission Zone: Supplemental

**Need Number: PPL-2023-0014**

**Process Stage:** Submission of Supplemental Project for inclusion in the Local Plan 3/19/2024

**Need Presented:** 10/19/2023

**Solution Presented:** 1/18/2024

**Supplemental Project Driver:** Customer Service

## Problem Statement:

PPL Distribution has submitted a request for a second 69kV feed at Lavino Substation to support replacement of existing transformers and rebuilding of the substation.

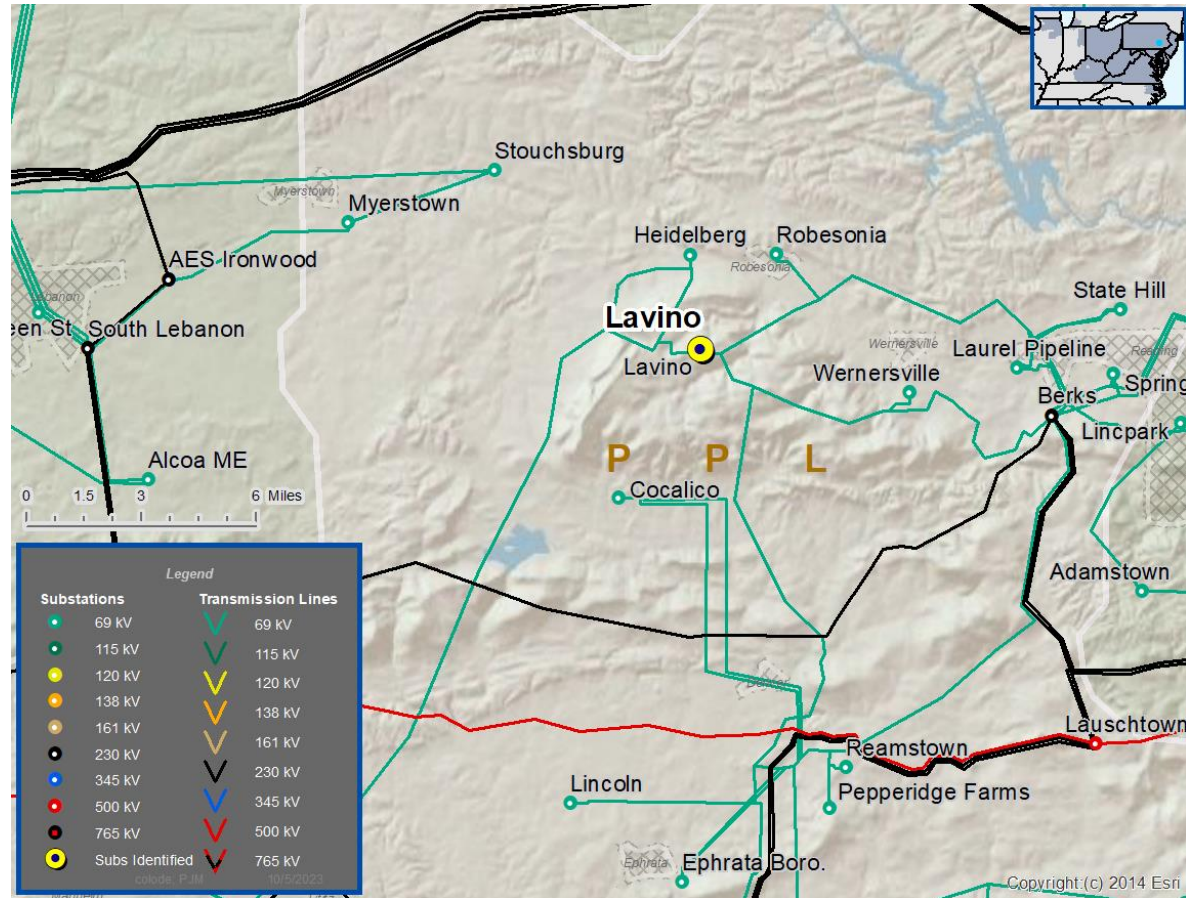

## Specific Assumption References:

[PPL 2023 Annual Assumptions](#)

**Need Number: PPL-2023-0014**

**Proposed Solution:**

Extend a second circuit to Lavino substation from the Berks – Lavino #2 69kV line (0.05 Miles)

**Alternatives Considered:**

- 1. No feasible Alternatives

**Estimated Project Cost: \$0.9M**

**Projected In-Service: 11/30/2025**

**Project Status: Conceptual**

**Model: 2026**

**Supplemental #: S3210.1**

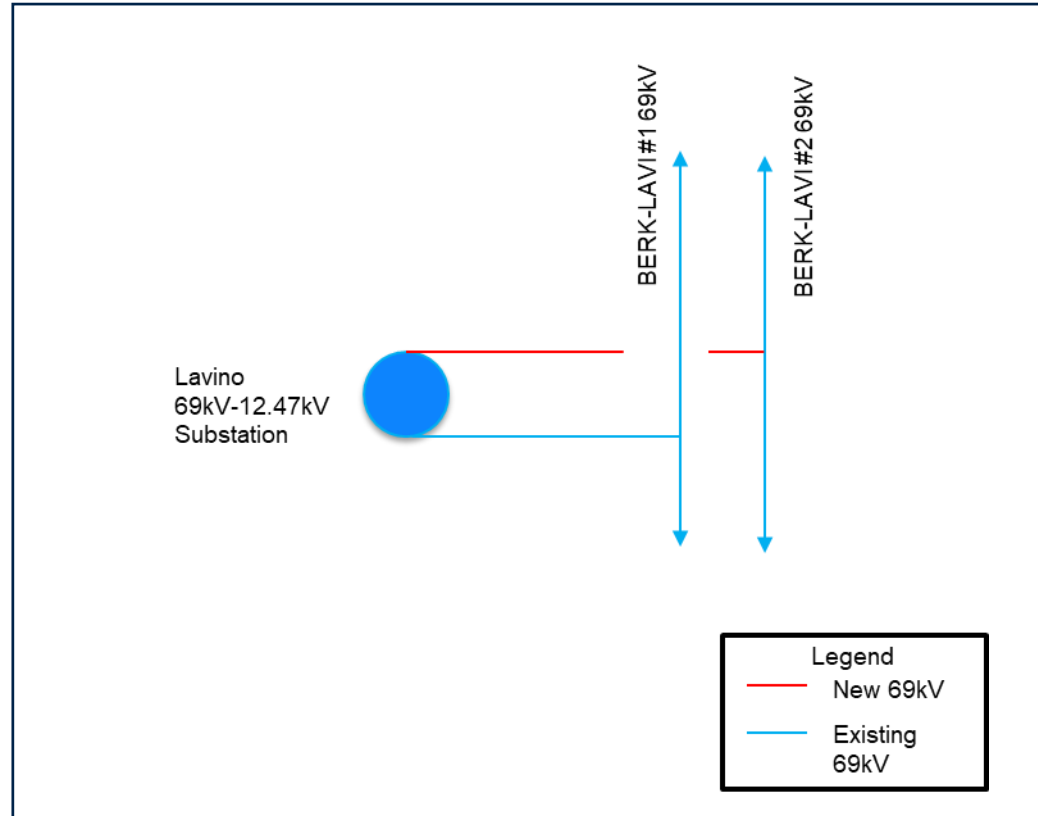

# PPL Transmission Zone: Supplemental

**Need Number: PPL-2023-0005**

**Process Stage:** Submission of Supplemental Project for inclusion in the Local Plan 3/25/2024

**Need Slide Presented:** 03/16/2023

**Solution Presented:** 07/20/2023

**Supplemental Project Driver:** Customer Service

## Problem Statement:

- PPL Distribution has submitted a request for double circuit 69kV service for a new 69-12kV substation near Hazelton, PA. There have been multiple requests for distribution service from new customers with a total expected load addition of **40-45 MWs**. The distribution system in the area does not have sufficient capacity to serve the load.

## Specific Assumption References:

[PPL 2023 Annual Assumptions](#)

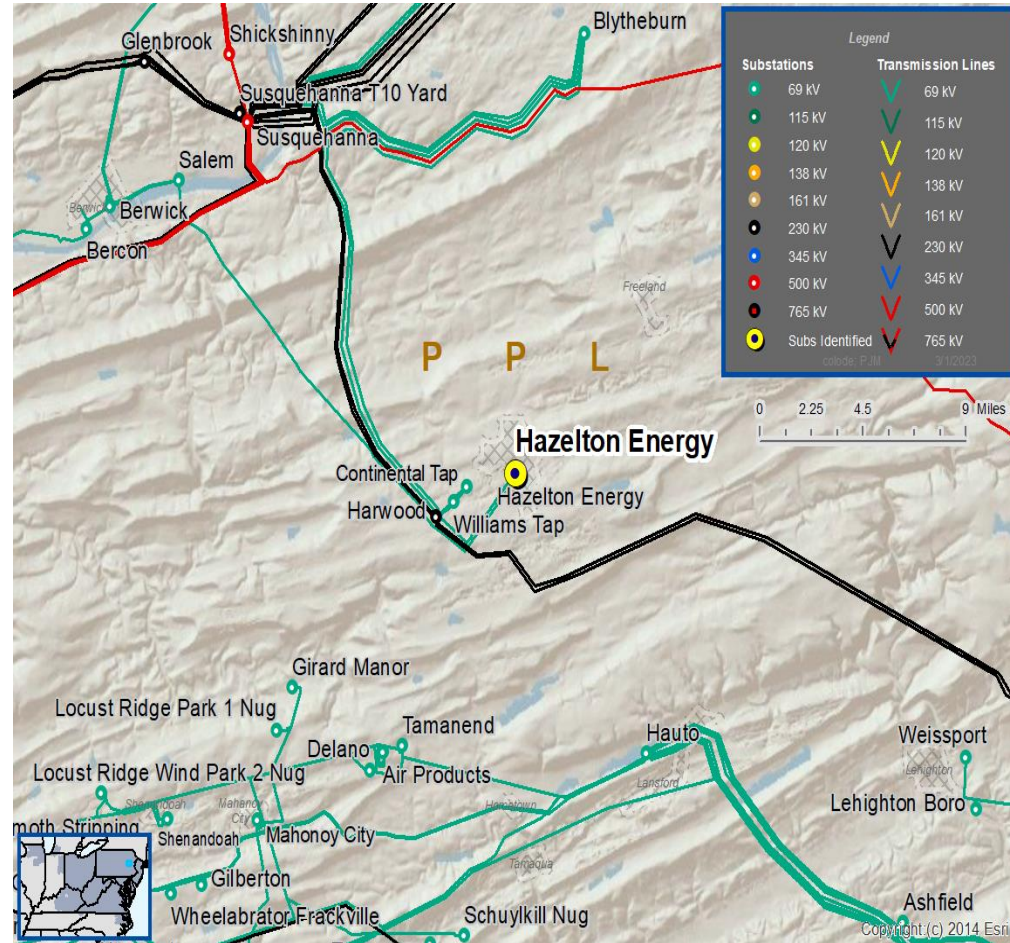



**Need Number: PPL-2023-0005**

**Proposed Solution:**

- Extend a new double circuit 69kV tap from the existing Harwood – East Hazelton 1 & 2 69kV lines line to interconnect a PPL Distribution owned 69-12.47kV substation (McAdoo). s3082.1
- Add a second circuit from Harwood substation to Cando tap (1.3 miles), reconfigure existing circuits from Cando and Harleigh, and install 3.6 miles of new double circuit 69kV from Harleigh to East Hazelton. s3082.2

**Alternatives Considered:**

Installing a new 230/69kV substation close to McAdoo but would cost greater than \$40 million.

**Estimated Project Cost:** \$15M

**Projected In-Service:** McAdoo sub (s3082.1) 6/12025, New circuit (s3082.2) 12/1/2027

**Project Status:** Conceptual

**Model:** 2027

**Supplemental #:** s3082.1 & s3082.2

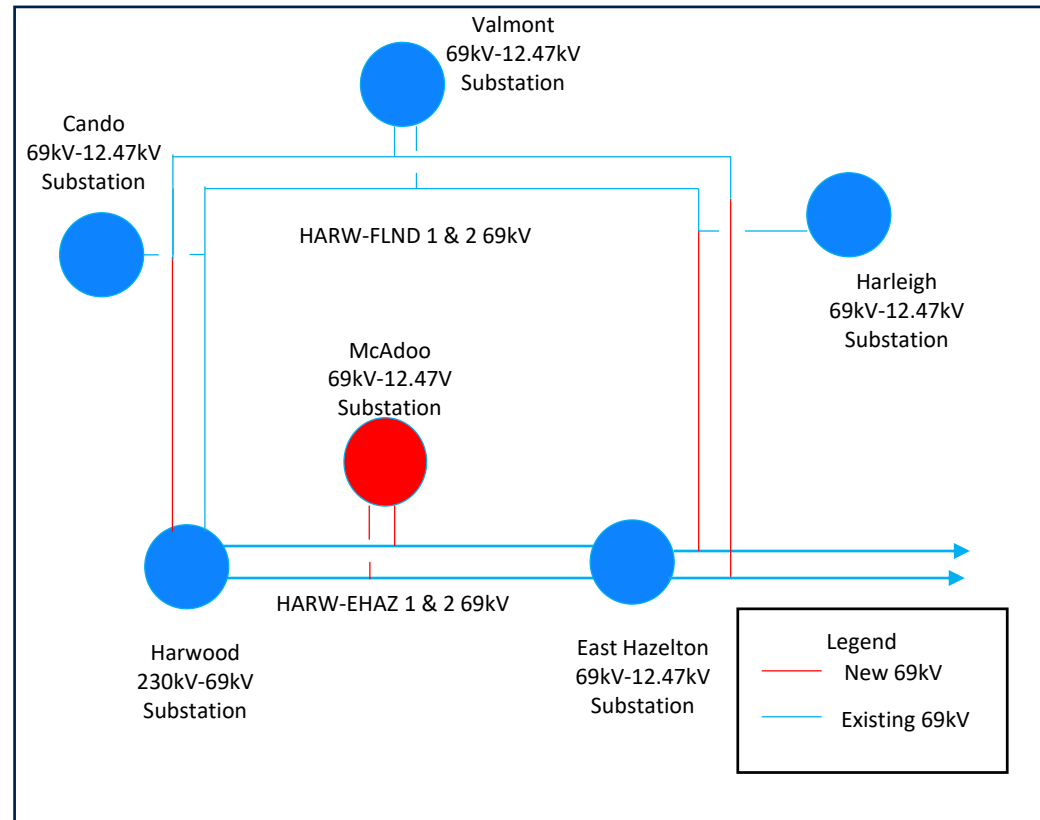

# PPL Transmission Zone: Supplemental

**Need Number: PPL-2023-0013**

**Process Stage:** Submission of Supplemental Project for inclusion in the Local Plan 7/29/2024

**Need Slide Presented:** 10/19/2023

**Solution Slide Presented :** 12/13/2023

**Supplemental Project Driver:** Equipment Material Condition, Performance, and Risk.

Operation Flexibility

**Problem Statement:**

- In a 2.6 mile stretch of the Harwood – East Hazleton 69 kV line, 20 of the 32 structures are weathering steel Corten lattice towers that were installed in 1970.
- A third-party inspection and analysis was conducted on a statistically significant sample of 192 out of the 1284 Corten structures on the PPL system. All the towers inspected exhibited section loss on numerous members and over 90% of the joints had visible pack-out.
- The report rated all the Corten towers inspected in poor or worse condition and concluded that the towers require near-term mitigation.
- Due to load growth in the area this section of line becomes the limiting factor for making transfers.

**Specific Assumption References:**

[PPL 2023 Annual Assumptions](#)

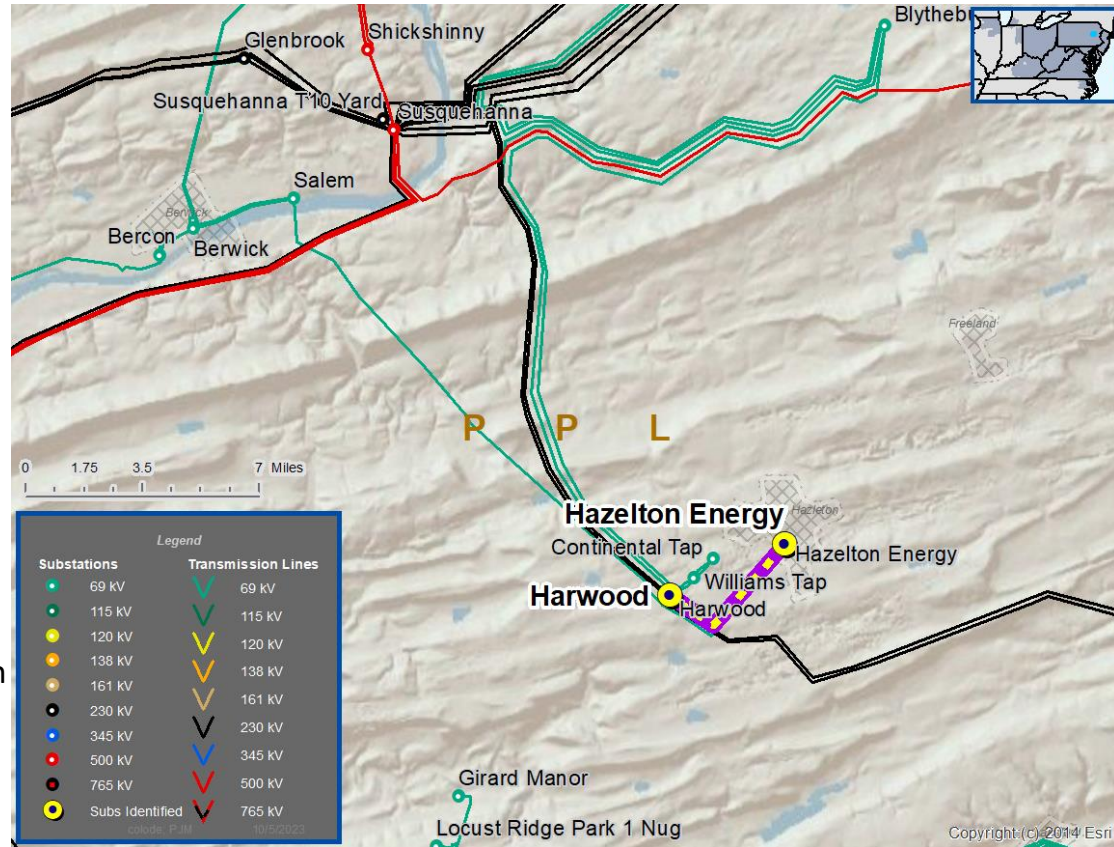

**Need Number: PPL-2023-0013**

**Proposed Solution:**

- Rebuild 2.6 miles of the existing Harwood – East Hazelton 1 & 2 69kV lines from Harwood Substation to the MCCI tap with 795 ACSR conductor.

**Alternatives Considered:**

No feasible alternatives. Line cannot be retired as it serves customer and distribution load.

**Estimated Project Cost:** \$6M

**Projected In-Service:** 12/1/2026

**Project Status:** Conceptual

**Model:** 2027

**Supplemental #:** S3349.1

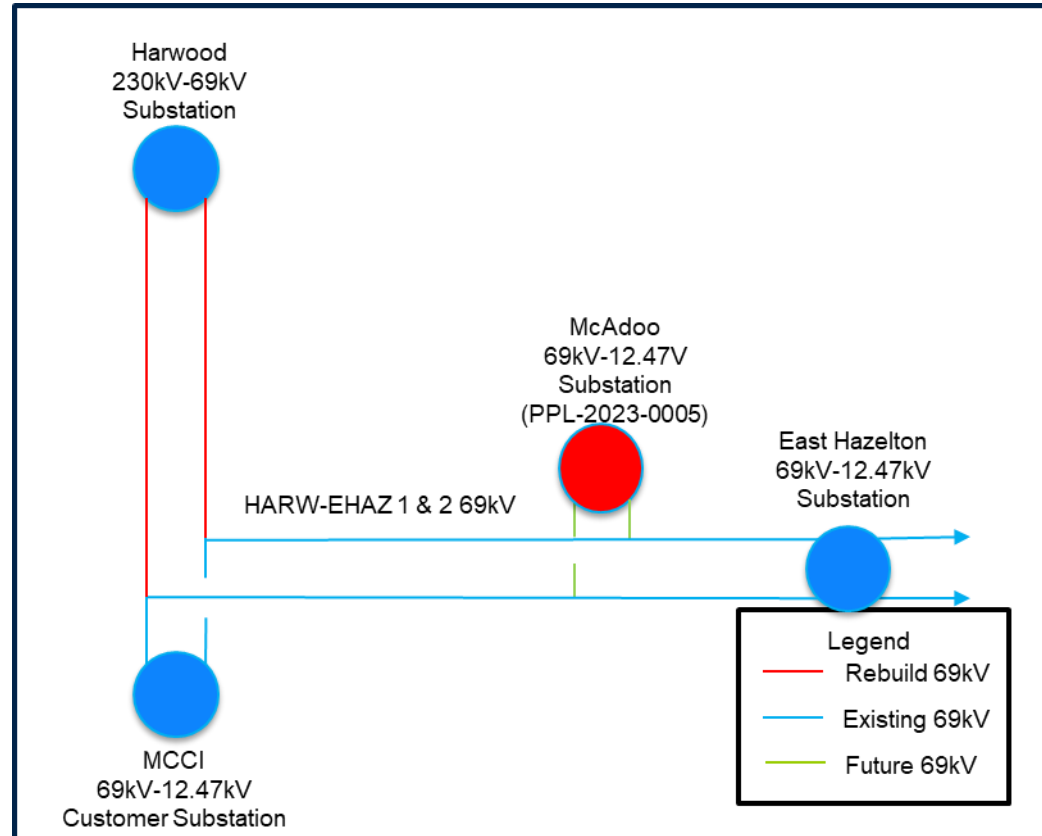

# PPL Transmission Zone: Supplemental

**Need Number: PPL-2023-0015**

**Process Stage:** Submission of Supplemental Project for inclusion in the Local Plan 7/29/2024

**Need Slide Presented:** 11/16/2023

**Solution Slide Presented:** 12/13/2023

**Supplemental Project Driver:** Customer Service

## **Problem Statement:**

PPL Distribution has submitted a request for modification of the 69kV feeds at Cass Substation to support replacement of existing transformers and rebuilding of the substation.

## **Specific Assumption References:**

[PPL 2023 Annual Assumptions](#)

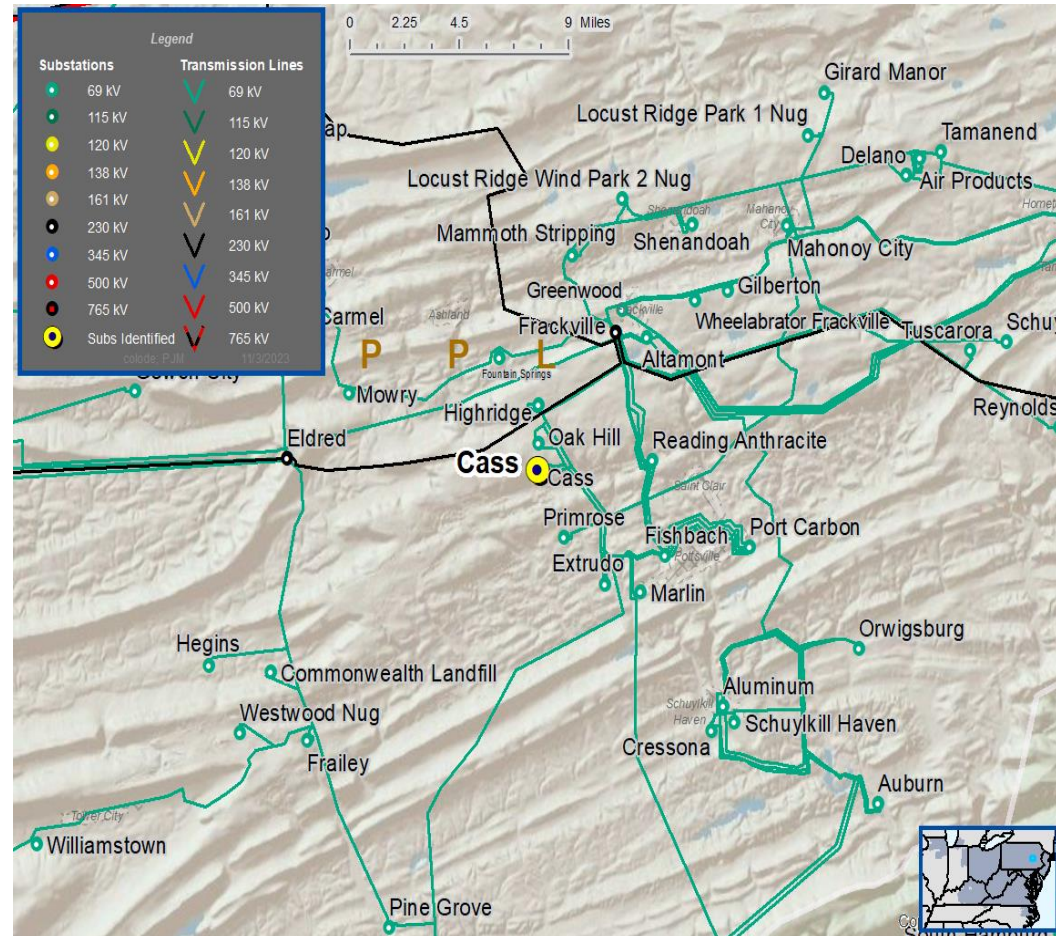



**Need Number: PPL-2023-0015**

**Proposed Solution:**

Rebuild the 0.1-mile Cass tap from the FRAC-AUBU 69kV line. Remove 69kV tap from FRAC-FISH #3.

**Alternatives Considered:**

No feasible alternatives

**Estimated Project Cost: \$0.9M**

**Projected In-Service: 5/31/2026**

**Project Status: Conceptual**

**Model: 2026**

**Supplemental #: S3350.1**

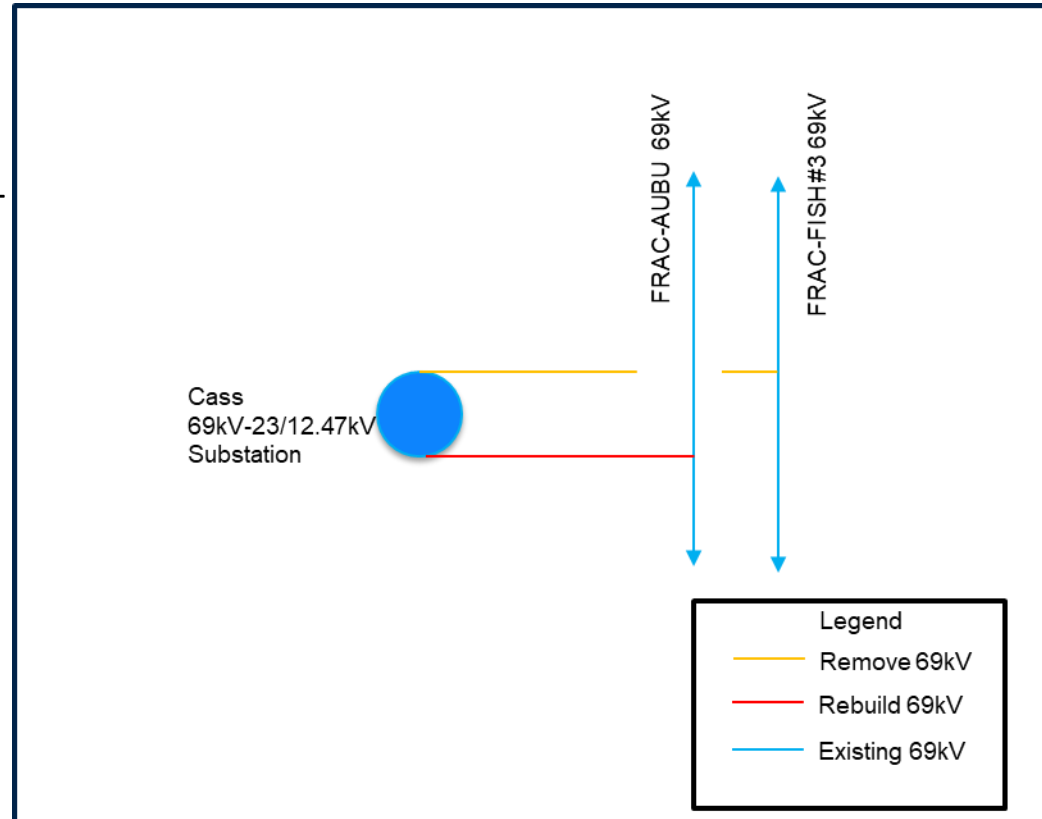

**Need Number:** PPL-2024-0002

**Process Stage:** Submission of Supplemental Project for inclusion in the Local Plan 09/05/2024

**Previously Presented:** Need Meeting SRRTEP-MA - 05/16/2024

**Project Driver:** Customer Service

**Specific Assumption References:**

PPL 2024 Annual Assumptions

**Problem Statement:**

PPL Distribution has submitted a request for double circuit 69kV service for a new 69-12kV substation near Carlisle, PA. There have been multiple requests for distribution service from new customers with a total expected load addition of 13-18 MWs. The distribution system in the area does not have sufficient capacity to serve the load. The requested in-service date is 6/1/2026.

**Specific Assumption References:**

[PPL 2023 Annual Assumptions](#)

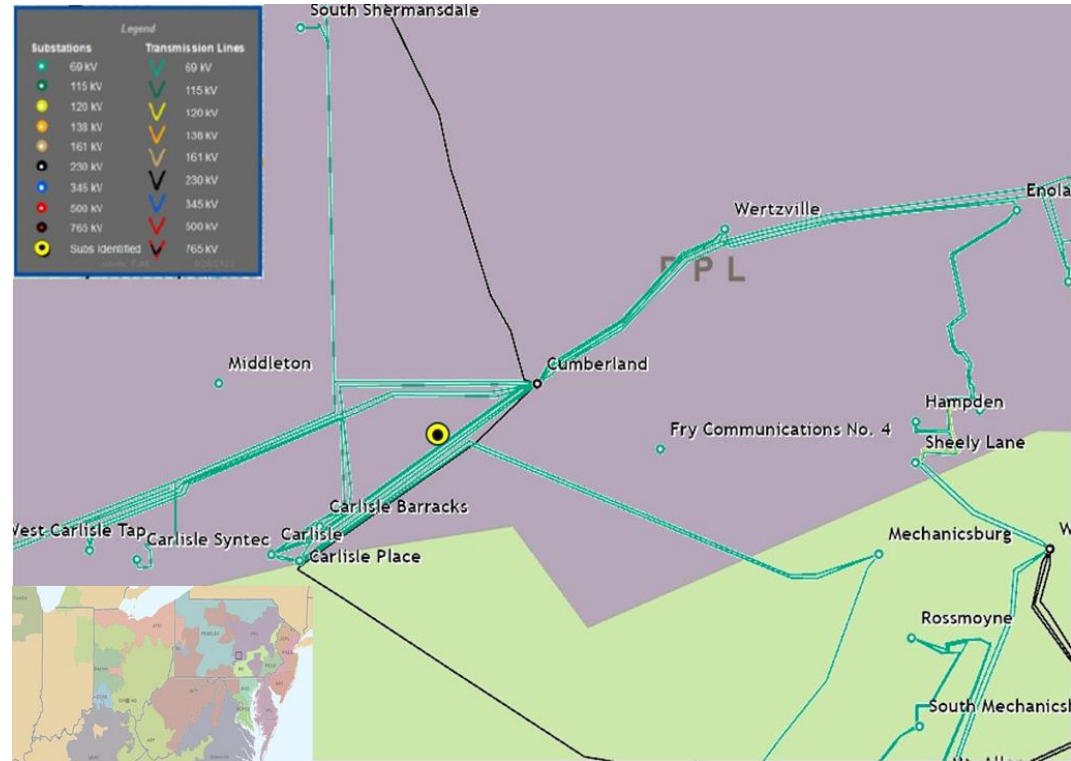

**Need number(s):** PPL-2024-0002

**Process Stage:** Submission of Supplemental Project for inclusion in the Local Plan 09/05/2024

**Proposed Solution:**

**Stonehouse 69kV taps:** Extend a new double circuit 69kV tap from the existing Cumberland - Carlisle #1 & #2 69kV lines to interconnect the new Stonehouse 69-12.47kV substation. Build 0.1 miles of new 69kV double circuit line using 556 ACSR conductor. Initial loading of ~18MVA. (s3391.1)

**Transmission Cost Estimate:** \$1.4 M

**Alternatives Considered:** No feasible alternatives

**Projected In-Service:** 06/01/2026

**Project Status:** Conceptual

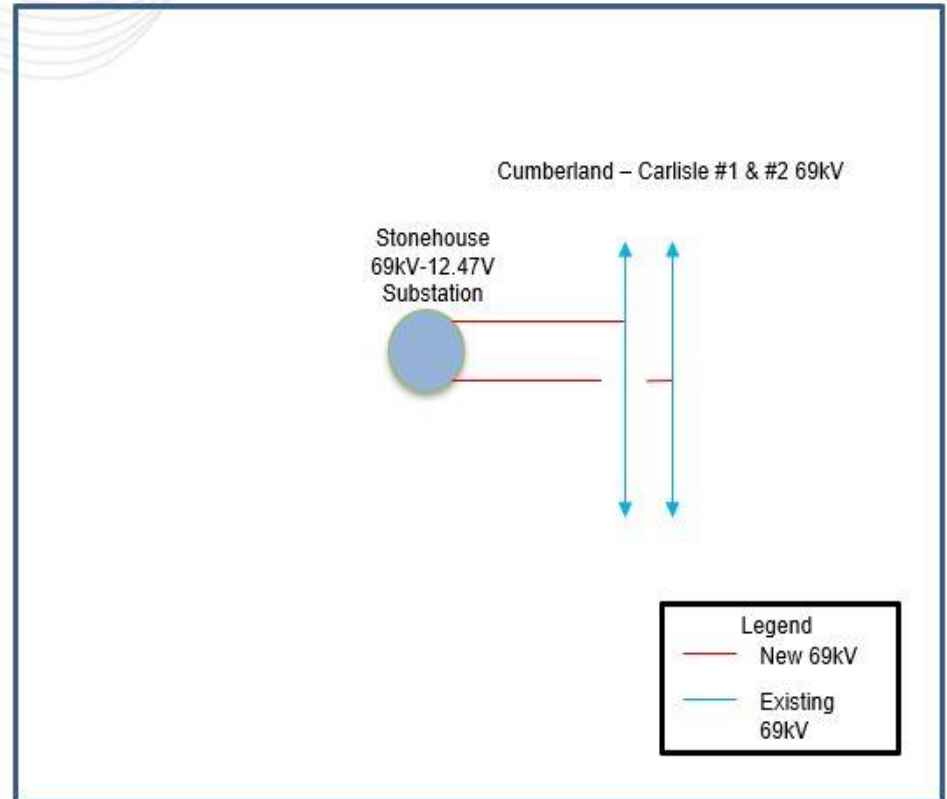

## Revision History

2/27/2024 – V1 – Local Plan for s3082.1 through s3089.1

3/19/2024 – V2 – Added s3210.1

3/25/2024 – V3 – Added s3080.2

7/29/2024 – V4 – Added s3349.1 and s3350.1

9/5/2024 – V5 – Added s3391.1